

## Cutubka 8<sup>aad</sup>

# DANAB IYO BIRLAB DANABOW

**Ujeedooyinka Cutubka:** Cutubkani makra uu dhammaado dabadeed waxaad Awoodi Doontaa in;

- ✓ Aad fahamtid fikradaha la xidhiidha danabka iyo Birlab- danabowga.
- ✓ Aad Horumarisid Aqoon taada xisaabinta Masalooyinka eela xidhiidha danabka iyo Birlab- danabowga.
- ✓ Aad ku qanacdid xidhiidhka ka dhaxeeya Alaabada (sheyada).
- ✓ Aad Adeegsatid waxyaalo Badan oo Suur to- galinaya Horumarinta Aqoonta ku saabsan Fikradaha Guud ee Fisikiska.

## Hordhac

Cutubkani wuxuu ka Samaysan yahay laba cinwaan oo waaweyn oo yidhad do Danabka iyo Birlab-danabowga. Marka hore wuxuu ka hadli doonaa Birlab- danabowga, dabadeedna Danabka. Birlabnimadu waxay ka hadashaa Astaamaha Birlabta halka Danabku uu ka hadlo Astaamaha elektaroonada fadhiya iyo kuwa socda xidhiidhka ka dhaxeeya Birlab- danabowga iyo Danabka waxaa lagaga hadli doonaa fasalka 8<sup>aad</sup>.

## Qaybta 1<sup>aad</sup> BIRLAB- DANABOW

### 8.1. Birlabaha

#### Hawlgalka 8.1

Hawalgalkan soo Socda qabta Adiga iyo saaxiibadaa, dabadeedna ka jawaaba su'aalaha lagu siiyey

- i) Soo buuqo Dukaanka dayac-tirka Raadiyowga Ama ka dayactirka kabaha Ama xidhmooyinka sayniska ee Dugsigaaga. Weydii qofka Masuulka ka ah in uu ku tuso Birlabo.
- ii) Waa maxay Birlab?
- iii) Birlab qaabkeedu Nooc ee yahay ayaad heshay?
- iv) Waa maxay alaabaha ay soo Jiidato ?

**Birlabtu waa Gobol xadiid ah kaasoo soo jiita walxaha sida xadiidk, Biraha daxla iyo Naxaasta fogaan go'an bayna ka soojiidataa.**

Ereyga “Birlab” wuxuu ka yimid Magaca Erey la dhaho magnesia oo ahayd Magaalooyinkii hore ee Bariga dhexe, Halkaas oo Birlabtii ugu horey say laga daahfuray (laga helay). Birlabtani Waxay ahayd qaab dhagax waxaana la dhihi jiray loodh istoon taas oo le micno ahayd dhagaxii hogaaminta loodh istoon ka ama dhagaxa hagaamin waa Birlab si dabiici ah loo helay’

**Birlabtu waxay noqon kartaa dabiici Ama dad-Samee, dhagaxa Birlabtu waa mid si dabiici ah u dhaca’ Birlabaha dad- sameeguna waa Birlabaha dadku Soo saaraan. Badanaa Waxay ka Samaysan yihiin xadiid iyo Biraha ka samaysan xadiidka sida Istiilka birlabta dad- sameega ahi waxay leedaha Qaabab kala duwan sida. Birdheer, Qoobka faraska, qaabka- u iyo Qaab dhululubo.**

**Fiiri jaanluska 8.1 si aad u kala caddeysid qaabaka Birlabaha**



b). Birlab- caadi ah



t). Birlab- dhululubeed

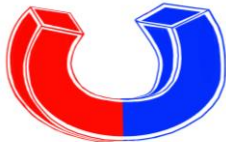

j) Birlabta kabaha Fardaha



D ) Birlabta Qaabka - UU- shaped magnet

**Jaantuska . 8.1 Qaabab ka kala duwan ee Birlabta**

**Walxaha Birlabta ah iyo Kuwa aan Birlabata ahayn**

Hawlgalka 8.2 Aad ayay u fududahay si aan u indha-indhayno in dhammaan walxuhu aanay jiidanin Birlabaha sidaas awgeed walxaha wax aa loo kala saaraa Walxo Birlabooba iyo kuwo aan Birlaboobin

**Hawlgalka 8.2 Si loo caddeeyo in walxuhu Birlabodbaan iyo in aanay Birla boobin.**

- i) Soo ururso walxaha sida- Musmaar xadiid ah, qadaadiic, Biinan, qalin, ul-looxaanah, caag I WM.
- ii) u dhawee Birlab walxahani iskuna day in ay mid- mid u soo jiidato
- iii) Buuxi shaxda hoos ku qoran adigoo isticmaalaya Sumadaha “X” Ama “✓” maxsuulka hawlgalk aaga X M istic maal kuwa aan soo jiidata

Walax	Soojiita	Aan Soo jiidan
— —		
— —		
— —		

**Birlabtu miyey soo wada jiidataa?**

- Walxaha kuwaasoo ay soo jiidan karta Birlabtu waxaa la dhahaa Walxaha Birlabooba xadiidak, Birka samaysan xadiid, Naxaasta iyo koobalka waa Tusaaleyaal Walxaha Birla booba ah.
- Walxaha aan Birlaboobini waa walxaha kuwaasoo aan soo jiidan Birlabaha caagga, warqada, looxa, bacda, Koobarka, Aluuminamka, Dahabka iyo Quruuradu (dhala) Waa Tusaaleyaal walxaha aan Birlaboobin ah. Dhammaan Biruhu ma soo jii taan Birlabta

### Hawlgalka 8.3- Samaynta Birlabta

i. Alaabta la rabo: Musmaar weyn, Biinan yaryar iyo Birlab.

ii. talaabada 1<sup>aad</sup> ku dhaqdhaqadji labada cidhif ee Musmaarka Biinan ka yar- yar, Musmaar ku miyuu soo qaatay wax Biinah?

iii. Talaabada 2<sup>aad</sup> ustucnaak kabada cidiifka ee Birlabta mid ka mid ah. Taabsii adigoo Ku celcelinaya jiho qudha uun musmaarka markasta ka qaad Birlabta, markaad gaaqdhoo dhemmaadka Musmaarka, ku soo noqo dhinacii aad ka Bilow day taabsiinta mar labaad taabsii sidii oo kale, sida ka muuqata jaanuska 8.2

- Hadda u dhawee musmaarka aad taabsiisay Birlabta Biinankii Marlabaad, maxaa hadda dhacay? Biinankii miyaa la soo jiiyay mise maya? Ku celi habkan

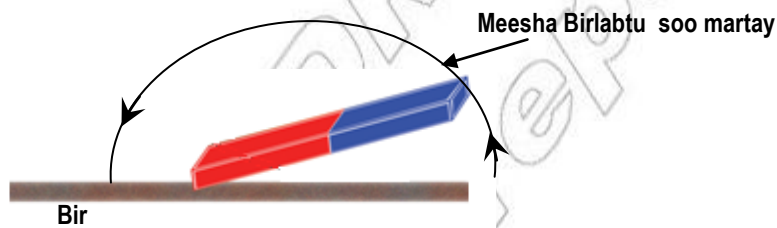

Jaantuska 8.2 Birlabaynta Birlaha xadiidka ah ayadoo la taabsiinayo

Habka walax loogu yeelo Birlabnimo Ayado la taabsiinayo Ama hababka kaleba waxaa la dhahaa Birlab- danabayn

Habka Birlab-danabaynta ee Hawlgalka 8.3 Cidhifyada Musmaarku Ama gobolka Birta la taabsiinayo waxay ku Birlab- danaboobayaan mid Lid ku ah ta ay leedahay cidhifyada Birlabta Hore. Sida- haddii cidhifka Birlabta la taabsiin ayaa uu yahay cidhifka

Waqooyi, dhinac lagu dhammeeyo taabsii NTU wuxuu yeelan koonfure sida ka soo horjeedaan waa sidoo kale.

Habkani Wuxuu leeyahay Faa' iido daro taas oo ah Birlabta lagu dhaliyey habkani ma yeelo Doono cidhifyada, labada cidhif ee dhabta ah. Dabadeed Waxaa Fiicnaan lahaa in la Isticmaalo habkal sida:-

Taabasha lammaanaha ah Ama ta Dubka si looga hortago dhibaato timaada

## Astaamaha Birlabaha

Waxaad ku Soo baratay cuttubka seddexaad ee Buuggan, in birlabtu ay ku fasho xoog qiyaas fogaan ahr waxay soo Jiidataa walxha Biraha ah Ama way kala Boodaan Birlabaha Kale Fogaan go'an go'an. Qeybtani waxaad ku Baran doontaa Astaamo kale oo Birlabtu Leedahay

- b) **Haddii Birlab la dhex-** galiyo saxaro Biro ah, dabadeedna la buxo si tudud, saxarada Biraha ahi waxay ku ururi doonaan cidhifyada Birlabta  
Hawlgalkan Waxaa ka ogaanay in xoogga Birlabtu uu ku Badan yahay laba cidhif. Labadan cidhif ee Birlabta waxaa la dhahaa cidhifyada birlab- danabeedka.



Jaantuska 8.3

Cidhifyada W iyo k ee birlabta cidhifyada Birlab-danabeedku waa labada Bar-dhammaad ee Birlabta halkaasoo xoogga soo jiidashadu ku badan yahay.

Haddii Birlab laga soo lulo xadhig dhuuban. Had iyo jeer Waxay tilmaantaa jihola Mid ah jihooyinka rasmiga ah ee joqoraafiga ee Waqooyi iyo koonfur.

### Kuwan Soo Socdaa waa qaar ka mid ah astaamaha Birlabta'

- i. Birlabtu way soo jiidataa xadiidka iyo Biraha.
- ii. Haddii Birlab ay soo laadlaado si madax banana, waxay had iyo jeer istaagtaa ayadoo labadeed cidhif sheegayaan ama u jeedaan jihada Waqooyi iyo koonfur
- iii. Birlabtu waxay leedahay laba cidhif
- iv. Daabkeeda iyo Baaxadeedu noocuu doono ha ahaadee labada cidhif markasta wey jiraan ayagoo lammaane ha.

## t) Xeerarka Birlab- Danabowga

### Hawlgalka 8.4 Fiirinta xeerarka

#### Birlab danabowga

- i. Ka soo laadlaadi Bir labaha mid ka mid ah, ta kalena Gacantaa kor ugu qaad
- ii. Ku dhawee cidhifka Waqooyi ee Birlabta, cidhif ka koonfureed ee Birlabta kale. Maxaad Aragtay?
- iii. Isku dhawee labada cidhif ee waqooyi ama labada cidhif ee koonfureed ee Birlabaha maxaad aragtay? Diiwaangali waxaad Aragtay
- iv. Maxaad ku soo Gabagabayn Waxyaalaha aad Aragtay?

Hawlgalka 8.4 wuxuu kugu hogaaminayaa Gabagabooyinkan soo socda cidhifyada Birlabnimadu waxay isku saqaan xoogag cidhifyada kale ee Birlab- danabka.

**Xeerka Birlab- danabnimadu wuxuu sheegayaa in: cidhifyada kala duwani isa soo jiitaan, kuwa isku midka ahina way kala boodaan**

Haddii add u kala jabiso Gobol Birlab ah laba qeyb bood, dabadeed cidhifyada waqooyi iyo koonfureed ma kala qeybsami doonaan. Laakiin qeyb Ama Gobol kastaa Wuxuu Noqon doonaa Birlab leh Cidhifyada waqooyi iyo koonfur labadaba hadaba ma jirto Birlab- danabeed kali ahi

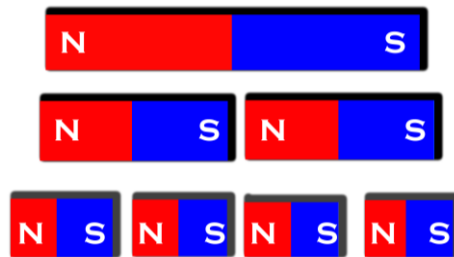

Jaantuska 8.5 kala jabin ta Birlabta

**Su'aal Furan**

**Waxaad ka soo qaadaa in Birlabi u kala jabtay laba qeybood**

Maxaa Ku dhici labada idhif ee Birlab- danabowga (N&S)?

**Waa maxay jiheeye?**

**Jiheeye waa Birlab yar oo lulata loona isticmaalo inay ina tusto jihada dhulka ee waqooyi.**



b) jiheeyaha jeebka



Jaantuska 8.6 Qaababka kala duwan ee jiheeyaha

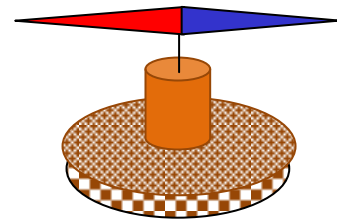

t) jiheeya he irbadaah

Jiheeyhu Wuxuu ka kooban yahay gobol Birlab ah taasoo laga taageeray Ama la dul dhigay ( la dalacay) Bar ay ku qotonto, taas oo ay si fudud ugu wareegi karta Ama u leexan karto sallaxa jiifa, Fiiri Jaantuska 8.6 iyo 8.7 marka Birlabta la dulfuushiyo ay is taagto waxay dhinaceeda Waqooy tilmaantaa cidhif ka waqooyi ee dhulka. Jiheeyuhu Wuxuu ka caawiyaa dadka Inay ku safraan Badaha, dhulka iyo Hawada, waayo mar kasta waxay sheegtaa jihada Waqooyi

**Badmareenada iyo Bayloodadu waxay u isticmaalaan jiheeyaha inay ku helaan jiihada socdaalkooda**

**Hawlgalka 8.5 sida loo sameeyu Jiheeye**

Ku xidh xadhig Birlab- dhululu beed, ka soo Laadlaadi Birlabta Adigoo ka fogeynaya Birlabaha iyo Alaabaha Birlabta soo jiita. Marka Birlabtu ay is tag to ogowjihada ay tilmaamayso. Birlabtu miyey u taalaa jihada wqooyi koonfur?

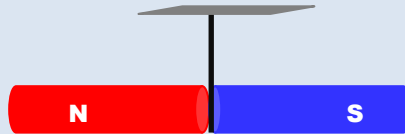

**Jaantuska 8.7 Birlabta la laadlaadiyey waxay tilmaameysaa jihada N-S**

**Hawlgalka 8.5** Waxaad ku soo Baratay in Birlabuha kuwaasoo Iskood u wareega loo isticmaali karo jiheeye. Waxaad si fudud Adigu iskaa U Samaysan kartaa jiheeye, sida ka Muuqata Hawlgalka 8.5

**Birlab- Danabowga Dhulka**

**Hawlgalka 8.6. Shaqo kooxeed**

**Kala dood Saaxiibada Ama waalidkaaga. Sababta jiheeyuhu Ama Birlabta laga soo laadlaadi yey meeli ay markasta u tilmaamaan cidhifka waqooyi ee dhulka?**

Baryhii hore waxaa la rumeysnaa in walxo samada yaalaa sida xidhigta waqooyi, ay jiheeyaha ka dhigayso in uu U jeedsado xagga Waqooyi- koonfur

Laakiin, hadda jaw aabta su'aasha xagga sare ku taalaa waa Birlab- danabowga Dabiiciga ah ee dhulka

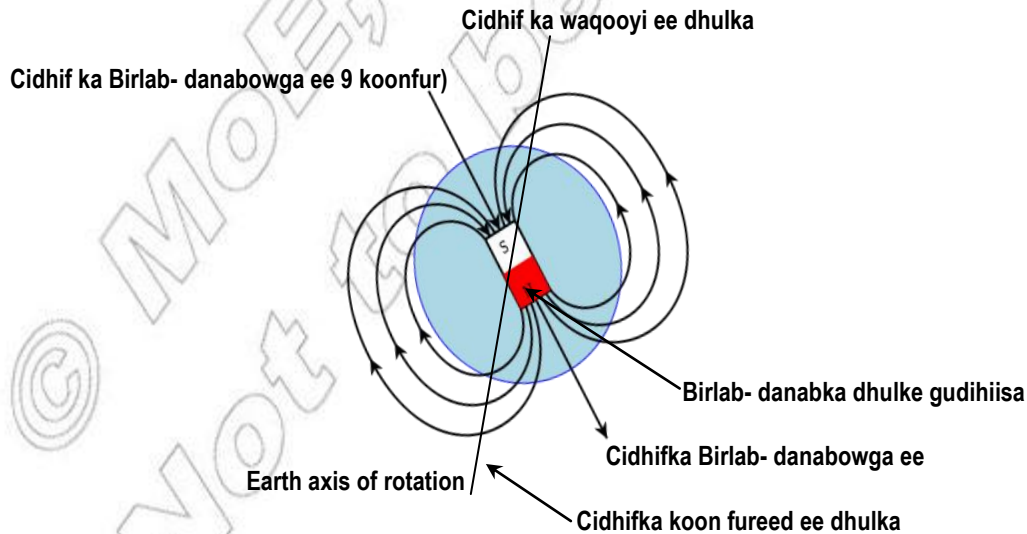

**Jaantuska 8.8 Birlab- Danabowga dhulka**

Saynisyahanadu waxay sharaxeen in dhulku yahay Birlab aad u weyn. Waxay Maleeyeen in Birlab-weyni ay dhulka ku dhexjir to

Cidhif keed Waqooyina laga helo cidhif ka koon Fureed ee Dhulka. Ci dhif Keed koon fureedna Laga helo cidhif ka Waqooyi ee dhulka. Birlabta la soo Laadlaadiyey Ama jiheeyuhu Hadiyo Jeer Waxay sheegaan Cidhifka Waqooyi ee dhulka Waayo, astaamaha Birlab- dana bee dka dhulka Awgeed.

Birlab- dan abeedka dhulka ee cidhifka koonfureed wuxuu soo jiitaa cidhifka Waqooyi ee jiheeyaha ama Birlabta laadlaada Birlab- danabeed dhulka socodkeed

Wuxuu la mid yahay Ka Gobol. Birlab ah oo aad u wyni oo leh Birlab- danabeedka cidhifyadu uu u dhow-yahay cidhifyada Dhulka ee waqooyi iyo koonfur ,

### Lix shay ee loo baahan yahay in aad ka ogaatid Birlabaha

Waxaad u baahan tahay in aad xasuusnaatid lix dhacdo oo ku saabsan sida Birlabuhu u dhaqmaan

1. Birlabtu waxay leedahay dhinac dhammaad oo ladhaho cidhifyo midka mid ah kuwan waxaa la dhahaa cidhifka waqooyi halka ka kalena ladhaho cidhifka koonfureed Cidhifka waqooyi ee hal Birlab ahi wuxuu soo jiitaa cidhif ka koonfureed ee birlabta kale, halka cidhif ka Waqooyi ee hal birlab ahi uu ka Boodo cidhifka Waqooyi ee Birlabta kale. Xeerka birlabtu wuxuu sheegayaa cidhifyada isku midka ahi wey kala Boodaan, kuwa kala duwanina way isa soo jiitaan
2. Birlabtu aan la Arki Karayn Baaxad aan la Arki karayn oo Birlab- danabaysan oo ku wareegsan lana dhaho Beerta Birlab- danabowga
3. Cidhifka waqooyi ee Birlabta dhulku waxay si aan caadi ahayn u tilm aanta cidhif ka waqooyi ee dhulka dhinaca kalena sidaa sida ka soo horjeeda taas sabab teed waa in dhulka laftiisu uu leeyahay walxo Birlab- danabaysan uuna u dhaqmo sidii Birlab aad u weyn
4. Haddii aad u kala goyso Gobol Birlab ah laba meelood oo lisle'eg waxay la yara mid tahay dhulka oo la kala badho waxaad heli qeybood oo cusub, Birlabaha yar-yari, midkastaa Wuxuu Leeyahay cidhif yadiisa wqooyi I yo koonfur
5. Haddii aad ku masaxdid Birlab walax aan Bir labaysnayn oo ah walxaha Birlab danabooba in muddo ah 9 sida xadiid hme musmaar) Waxaad ka dhigi kartaa Birlab, tani waxaa la dhahaa Birlab-danabaysan

#### Xaqiijin

1. Waa Maxay Birlab?
2. Waa maxay Astamaha Birlabtu?
3. Kala sooc walxaha Birlab danabooba iyo kuwa aan Birlab- danaboobin (ka Bixi midk asta waxogaa Tusaaleyaal ah)?
4. Waa maxay cidhifka Birlab- danabeed ku?
5. Sheeg (tax) xeerka
6. Waa maxay jiheeye? Sharax isticmaalkiisa
7. Sharax sababta Birlabta la soo Laadlaadiyey ay had iyo jeer u tilmaanto cidhifyada Dhulka ee waqooyi sia ay had iyo Jeer u tilmaanto cidhifyada Dhulka ee waqooyi iyo koonfur

## 8.2. Muujinta Xariiqyada Xoogga Birlab-Danabeedka

### Hawlgalka 8.7

Kala dood Saaxiibadaia

- Waxa uu yahay xoogaga aan is taaban? Side u sharixi kartaa in xoogaa Birlab-danabowgu uu yahay xoog aan istaabasho ku'imaan?
- Sharax Bey'ada Birlabta iyo xariiqyada xoogga Birlabta

### Hawlgalka 8.8 Muujinta Bey'ada Birlabta.

b) Indho- indhaynta xariiqyada xoogga Birlabta

- Alaabada loo baahan yahay qurubyo xadiid ah, Gobol birlabah, Warqad Habka la raacayo Dhig warqada Birlabta dusheeda Adigoo jiifinaya miiska dushiisa
- Ku daadi qurubyada xadiidka ah Warqada dusheeda adigoo ku dul- Shubaya Birlabta
  - Maxaad Aragtay? Maxaad u Bixin lahay meesha ku Wareegsan Birlabta?

t) Muujinta bey'ada Birlabta ayadoo la Isticmaalayo jiheeye' alaabada loo baahan yahay jiheeyaha jeebka, Gobol Birlabah iyo warqad. Habka la raacayo Dhig Birlabta warqada Dusheeda

- Dhig jiheeyaha meel u dhow cidhifka waqooyi calaamadeena jihada.
- Ku celceli hawlgalkani meelo Kala duwan oo ku Wareegsan Birlabta
- Sawir jihooyinka jiheeyuhu tilmaamo eek ala duwan
- Jiheeyuhu wuxuu ina tusayaa jihooyinka Badada Birlabta ee ay ka jiraan xariiqyada xoogga Birlab-dan abeedku

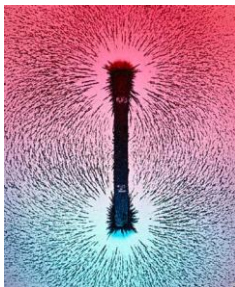

b) qurubyo xadiid ah oo ku wareegsan gobolka Birlabta ah

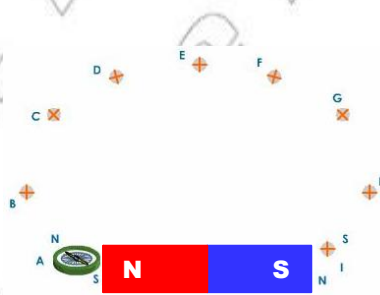

t) jiheeye ku wareegsan Gobol Birlab ah

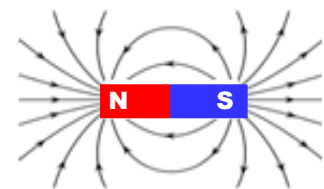

j) xariiqyada xoogga Birlabta eek u wareegsa gobolka Birlabta ah.

### Jaantuska 8.9

Waxaad hore u soo baratay in Birlabtu ay ku saaqdo xoog fogaan Bey'ada ku wareegsan Birlabta Waxaa la dhahaa badada Birlabta

Badada Birlabta waa Gobolka Ama Agagaarka kaasoo cidhifyada Birlab-danabeedku ay ku saqaan Xoog Ama ku falaan xoog badada Birlabtu waxay u jirtaa ayadoo ah xoog xariiqyo qiyaaseed (Imaginary lines) oo la yidhaahdo xariiqyada xoogga Birlabta.



**Xariiqaha xoogga Birlabtu waa xariiqo la qiyaasay kuwaasii si isdabajoog ah ugu taagan jihada Badada Birlabta**

**Astaamaha Xariiqyada xoogga Birlabta**

1. Xariiq yada xooga Birlab- danabeedka ee gobol Birlab ahi had iyo jeer wuxuu ka soo baxaa dhinaca cidhifka Waqooyi wukuuna Raaca jid xoodan waxuuna Galaa cidhif ka koon fureed Dabadeedna Waxay dib ugu soo Noqdaan cidhif kii waqooyi ayagoo dhex-maraya Birlabta, kana Imanayaa Birlabta koonfureed kuna Noqonaya cidhifka Birlabta Waqooyi . Haddaba, waa Xariiqyo Isu- dhow dhow
2. Xariiqyada xoogga Birlabtu Waligood isma- jaraan
3. Cidhif ka Birlab- danabeed ka Meel u dhow, taasoo xoogga Birlab- danabeed Aad ugu badan yahay, xariiqyada Xoogga Birlab danabeedku aad ayey Isugu dhow yihiin Marka cirifyada Birlab- danabeedka Laga fogaadoba Xoogga Birlab- danabeedku hoos ay uu u dhacayaa, xarii qyaduna way kala firdhaan

- **Birlabtu waxay ku fashaa xooq fogaan (ama qiyaas)**
- **Jihada Birlab- danabeedku waxay ina tustaa, jihada xoogga Birlab- danabeedka**
- **Isu dhawaanshaha xariiqaha Badada Birlab- danabeedku waxay ina tustaa xoogga Birlab- danabeed Ka.**

**Xaqijinta 8.2**

1. Waa Maxay xariiqaha xoogaa Birlab- danabeedku?
2. Sharax Astamaha Gaarka ah ee xariiqaha xoogga Birlab- danabeedku
3. Sawir xariiqaha xoogga Birlab- danabeedka
  - b) gobol Birlab ah iyo
  - t) kuwa u dhexeeya laba cidhif oo birlab- da nabeed koodu Kala duwan yahay .

**8.3 Istic Maalka Birlabaha**

Hawlgalka 8.1 waxaan ku soo Aragnay dukaaNo kala duwan kuwaasoo Birlabaha u isticmaalaya u jeedooyiN kala duwan

**Hawlgalka 8.9**

**Tax ama Qor waxyaalaha ugu caansan ee loo isticmaali karo Birlabaha**

Birlabuhu waxay leeyihiin dabakhaad kala duwan ( isticmaal) Isticmaaladan qaar ka mid ahi waa

- Birlabaha ku jira jiheeyey aasga Waxaa loo isticmaalaa si ay noogu sheegto jihooyin Badaha Badweynada, Hawada iyo dhulka dushiisa
- Waxaa loo istic maalaa in kor loogu qaade xadiidka Ame Biraha meel aad u sareey sa'

- Waxaa loo isticmaalaa Samaynta jalasyaala, mishiinada, raadiyaha Ama Idaacada, Miishiinada yar- yar lwm
- Waxaa loo isticmaalaa in lagu kala sooco walxaha Bir lab- danabooba sida xadiidka loolga soo saaro walxo kala duwan oo laysku qasay.

### Hubinta 8.3

#### 1. Qor sharaxna Isticmaalka Birlabta

## QEYBTA -2 aad

### 8.4. Hawlgalka

#### Hawlgalka 8.10

##### Hawlgalka 8.10

- Maxaa sababa hillaaca iyo jacjacda yare e codka ah ee baxda marka aad xidhanayso dharka Nayloonka ah Maxay saqafta ka samaysan caagu u soo gurataa gobolada yar yaree xashii shka warqadaha Fudud marka Timaha lagu feedho Ama mariyo dabadeed?
- Maxaad ka fhintay tibixda ama weedha “danabka negi”?
- Waa maxay korontada?

Qeybtan waxaad Ku bilaabi doontaa inaad ku barato dhacdooyin Muhiim ah oo ku Saabsan korontada negi Dhammaan Hillaacyada aad Aragtaa iyojacjada aad jabaqdooda maqashid markaad xidhanayso dharka Nayloonka ah saamaynta korontadu waa danabyada Nagi.

Barashada korontada danabka negi Waxaa la yidhaa

Elektarostaatikis. Marka laba shay laysku xoqo, Waxaa jira Isliis isliskani wuxuu Sababaa in shaygu (walaxdu) soo jiidato Waxyaabaha aan danabka lahayn Haddii ul dhalo lagu xoqo dhogor, waxay yeelan Awood ay ku soo jiidato walxaha Fudud sida waraaqaha yar- yar Ama Warqada Aluumiyamka. Walax soo jiidashada Ku yeelatay xoqid waxaa la yidhaa wey danabowga ( Electricied)

**Laanta ka midka korontada taas oo lagu Barto Danabka negi waxa la dhahaa Elektarostaatikis**

### Waa Maxay Danabku?

#### Hawgalaka 11

Nakhtiin Aqoon taadii Kimistariga si aad ugu jawaabtiin Su'aalahan Soo socda adega iyo saaxii badaa

- Waa maxay Atomku?
- Waa Maxay labada ' Nooc ee Danbku?
- Borotoonku Danab Nooc ee ah ayuu qaadaa?
- Elektaroonadu Dnab Nooc ee ah ayey qaadaan?
- Goormaan Dhihi karnaa Atomku Wuu DANABAYSAN yahay?

Maxsuul Ka Soo Baxay tijaabooyln badan oo la sameeyey wuxuu ina tusinayaa xaalado xilliyo Gaar ah in maaterku uu muujiyo Astaamo cusub. Astaantani aakhirkiisa waxay raad ku yeelatay Atamka waxaana la yidhaa danabka Korontada

**Danabka Korontadu waa astaanta duleed oo ay dhaxlaan Ama leeyihiin qurub- hoosaadyada atamku Kaasoo Masuul kaah danaboobida uyi dhacdooylnka Birlab- danabeedka Danabko waxaa U taagan “Q” halbeega Danabkuna waa Kuulam (c)**

Qurubka ugu yare e Curiyaha waxaa La dhahaa Atam. Seddexda qurub ee ugu muliimsa qurubyada Atamku waa borotoono, elektaroono, iyo Niyuutaroono. Waxaana Loo yaqaanaa Aasaaska dhismaha Atamyada oo dhan Jaantuska 8.10 wuxuu ina tusayaa muuNad sida qurubyadanI ay U sameeyaan Atam. Bortoroono iyo neyuutaroonada Waxaa laga helaa Badhatma Atomka waxaana loo yaqaanaa By'da Atam ka.

Elektaroonaduna waxay ku wareegsan yihiin Bu'da Atamka Waxay ku wareegaa udub-dhexaadka Bu'da Atamka xawaare aad U Sareeya' Danabka koroNtadu Waa Astaan U gaar ah in badan oo qurubada Atam-hoosaad yada ah. DaNabka Korontadu waa Astaan uu leeyahay maaterku kaasoo dhaxalsiiya in uu soo jiito Ama ka boodo maater kale.

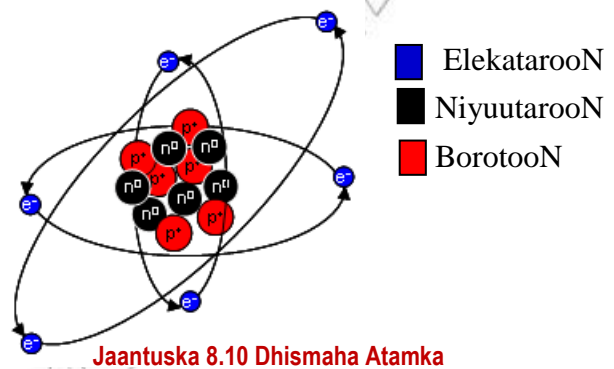

### Noocyada Danabka

Fikrada korontadu waxay Ku salaysa tahay Aragtida odhanaysa dhammaan Maaterku, Waxay ka samaysan yihiin Atamyo' Atam kastaa Wuxuu leeyahay Xudun (wadNE) yar oo la yidhaahdo Bu' da. Bu'da hareeraheed ana waxaa ku wareega tiro elektaroono ah. Bu'da Atamku waxay ka kooban tahay NiyuutarooNo iyo Borotoono.

### Danabyada Togan iyo Ka Taban

Si aan ku soo sheegnay xagga saree Atamku wuxuu Ka Kooban yahay Qurubyo niyuutaroono, Borotoono iyo Elektaroono ah

- i. Niyuutaroonku waa qurubka Dhexdhexaadka ah ma laha danab.
- ii. Borotoon ku waa qurubka leh Danabka togan
- iii. Elektaroonku waa qurubka taban Ama leh danabka taban

**Hadaba, waxaa jira laba Nooc oo danab ah lana dhaho danabka togan iyo danabka taban. Danabka taban waxaa qaada Elektaroon ada, danabka togana waxaa qaada Bortoonada.**

Meesha la dhigayo calaamadaha Danabka waxaa si bakhtiyaanasiib Ama sii aan la dooran loo sameeyey sanado Badan Ka hor Waxaanan isticmaalaa hadda

### Ka Fiirso Qodobadan soo socda

- i. Maater kastaa Danab buu leeyahay
- ii. Waxaan haysanaa laba Nooc
- iii. Xaalada caadiga ah, tirade elektaroonadu waxay la mid yihiin tirade Borotoonada ee Atamka sidaas darted, Atamku waa Bilaa danab guud ahaan tani waxay ina tusaysaa sababta walaxi aanay u lahayn (dhaxlin) Danab xaaladaha caadiga ah
- iv. Haddii waxoogaa eldektaroono ah laga qaado walax aan danab lahayn, waxaa dhici inay hoos u dhacaan elektaroonada walaxdu dabadeedna waxaa siyaadin Ama badan toгнаanta walaxda.
- v. Haddii walax dhexdhexaad ah Ama aan danab lahayn, lagu Daro elektaroono, waxaa dhici in elektaroonadu Bataan, dabadeedna walaxda waxaa la dhihi waxay leedahay danab taban.

#### Hubin (xaqiijin) 8.4

1. Maxay U taagan tahay tibaaxda danabka negi?
2. Sharax labada Nooc ee danabka korontada
3. Waa maxay danabka
  - b) Borotoonada
  - t) Elektaroonadu

### 8.5. Habka loo Danabeeyo Walaxaha

Danabeyntu waa habka Ama jidka lagu danabeeyo Ama koronto loogu yeelo walxaha sida ka qaaidid Ama ku daris lagu ddaro elektaroono walaxda

**Waxaa jira Habab kala duwan oo walaxda loogu yeelo danab**

b) Danabaynta ayadoo lagu xoqayo

T) Danabaynta Ku timaada gudbinta

#### i. Danabaynta Ku timaada xoqidaha

##### Hawlgalka 8.12 Danabaynta ku timaada xoqida

**Alaabta (Qalabka) Gobol warqadah, Qotin boditeen ah (Gadhfeedh caagah, mastarad caagah, Bii bii, Qalin) dharka samaysan dhogor Ama Waxaad isticmaali kartaa timahaaga Jidka la raacayo.**

- i. U kala googoo warqadaha qurubyo yar-yar dul-dhigna miiska
- ii. Taabsii qotin ka Boolitiink ah Adigoo aan Ku xoqin, Fiiri waxa dhaca
- iii. Hadda ku xoq qotin ka bolitiinka ah dharka dhogorta ka samaysan (Timahaaga) una dhawee waraaqaha yar-zar. Fiiri waxa dhaca Miyaad sharixi kartaa waxay sidaniu dhacday?

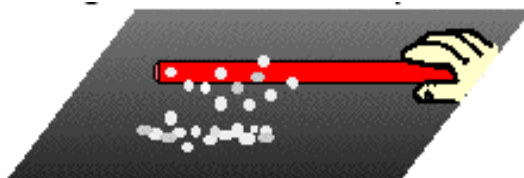

**Jaantuska 8.11 qotinka caaga ah ee DanabaysaNi wuu soo jiitaa gobolada yar yare e waraaqaha ah**

Dhismaha Atamka waxan Ka fahim karnaa in isku xoqida laba walxood ay sabato in elektaroonadu u kala gudbaan walax ayna ugudbaan walax kale. Midka mid ah walxuhu waxay kale. Midka mid ah walxuhu waxay heshaa elektaroono halka ta kale ay elektaroono lumiso tusaale ahaan hawlgalka 8.12 marka qotinka caaga ahi lagu xoqo Dharka ka samaysan dhogorta ( Timahaaga0 elektaroonadu waxay ka gudbi doo Naan qotinta caaga ah waxayna u gudbi karaan dharka dhogorta ka samaysa n (timahaaga) hadaba Qotinka caaga ahi wuxuu yeeshaa Danab taban halka dharka dhogorta ahi ka yeesho danfab Togan.

## ii. Danabaynta Gudbinta Kutimaada

Marka walax aan danab lahayni ay haleesho ama taabato walax danabaysan waxay la wadaagtaa danabka waxayna Noqotaa mid danabaysan. Danbaynta ku timaada Gudbinta waxay Ku dhaxeeya walaxda Ama walxaha Danabaysan iyo kuwa aan danabaysn ayn.

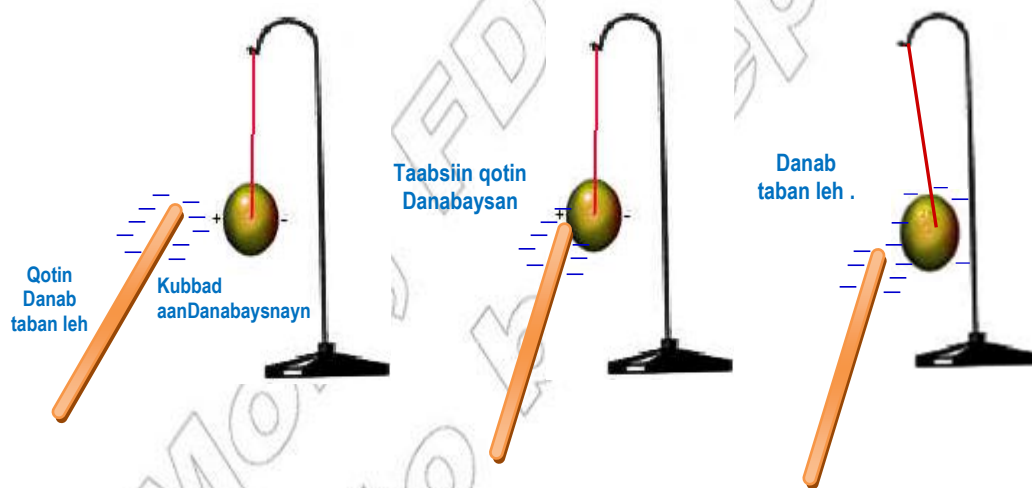

**Jaantuska 8.12 Danabaynta kubbada 9 Bii biida) ee habka GudbiNta**

**Tusaale ahaan** (qaado) walax Danabaysan, taasoo haysata elektaroono badan. Haddii aad u dhawysa qotinka ka walax aan danabaysnayn, wey soo jiidan Walax da aan danabaysnayn Marka walax Danabaysaniayn taabato walax aan danabaysnayn, Waxogaa danab taban ah ayaa u gudba walaxda aan danabaysn ayn, waxayna ka dhigaan mid leh danab taban.

Dabadeed labada walxood wey kala boodaan mid ba midka kale, waayo waxay leeyihiin Danab Isu mid ah.

Jidka lagu danabeeyo walax ayadoo la taabsiinayo walax danabesan waxaa la dhahaa “daNabaynta GudbiNta Ama wadaaga”

DANAB-LUMINTA WALXUHU waa habka lagaga Baabi’iyo walax danab leh dnabkeedii walaxda danabaysani waxay ku lumin Kartaa donabkeeda taabasho la taabsiiyo walax gudbiye ah. Marka walaxi lumiso danabkeeda waxay Noqotaa dhex dhex aad

### Hubin (xaqiijin) ta 8.5

1. Sharax Tibixda AMA weedha danab.
2. Sheeg labada habee walax lagu danabeeyo
3. Isbar-bar dhig danabeynta xoqida iyo ta wadaagida (istaabas hada)
4. Goorma ayaan dhihi karnaa walaxi waxay leedahay Danab togan?
5. Goorma ayaan dhihi karnaa walaxi waxay leedahay Danab Taban?

## 8.6. Xeerka Danabka Negi

### Hawlgalka 8.13 Sharaxida Xeerka DANABKA NEGI

*Qalabka loo baahan yahay kubbadaha Danabka, Quruurad Ama dhalo, qotin caag ah, dhar dhogor ka samaysan, dhar xariir ah.*

- i. Kubbada Danabku waxay leedahay danab togan oo ay Ku heshay gudbin Ama taabasho ay taabatay tiirka dhalada ah ( Jaantuska 8.13 (b))
- ii. Giiti escs fhsv s
- iii. Ku celin ticilkan qotin caagah iyo qotin caag ah oo ku samaysay xariir, Danabee kubada kale adigoo taabsiinaya ( jaantuska 8.13 (t))
- iv. U dhawee labada kubbadood midka la taabsiiyey Qotinka dhalada ah, kubbada kalena taabsii qotinka caaga ah ee Danabeysan. Kubbadahan danabaysan, isu dhawee midba, nudka kale ( jaantuska 8. 13 (j))
- v. Fiiri waxa dhaca
- vi. Fiiri waxa dhaca
- vii. labadan Kubbadood wey isa soo jiidan, waayo waxay sitaan Danabyo kela duwan

Sida caad ada ah danabka taban waxaa u taagan (-) , ka togana waxaa u taagan (+)

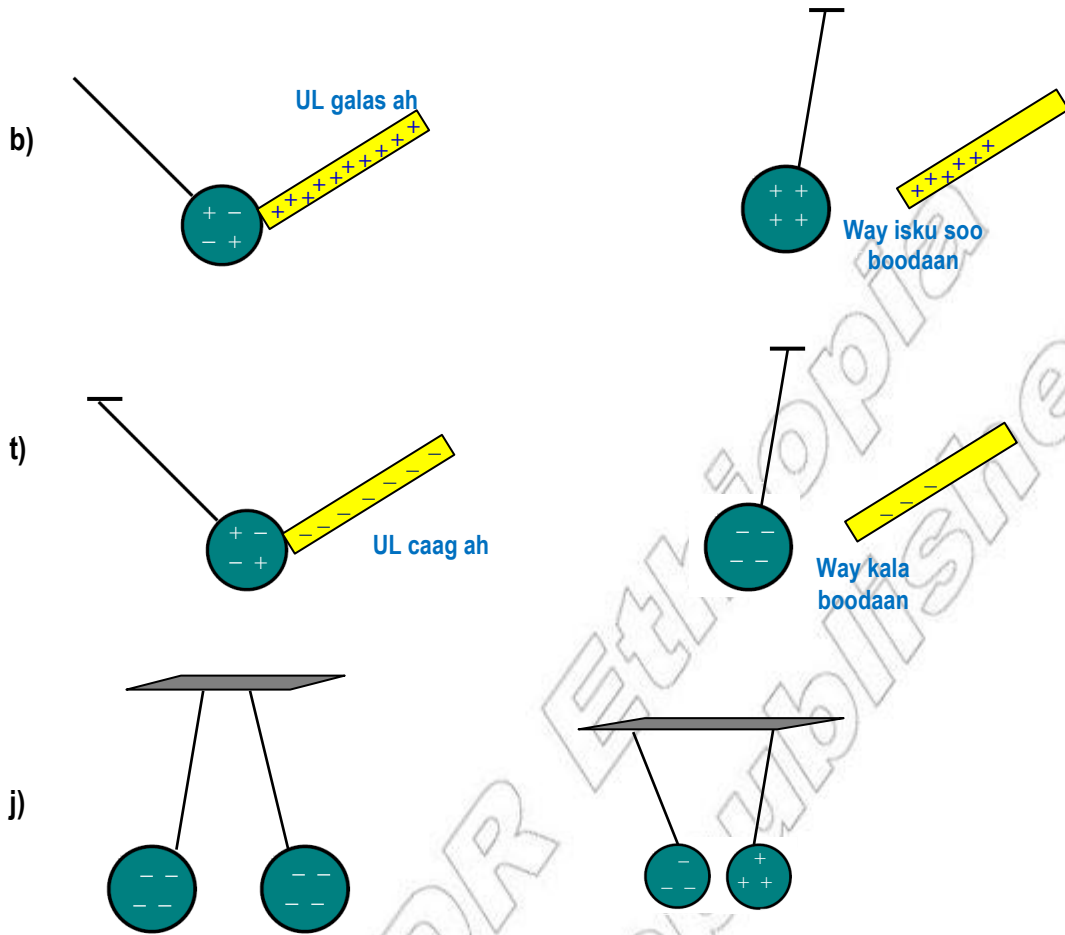

Jaantuska 8.13 xeerka Danab ka Negi

Waxaad ku soo baratay cuttubkii 3<sup>aad</sup> ee Buuggan in Danabka koorontadu uu xoog kaga saaqo fogaan, wuu soo jiitaa Ama way kala boodaan walxaha kale ee danabaysani ayagoon si toos ah isu taaban. Danabka korontadu wuxuu leeyahay Astaamo la mid ah ka xoogga Birlab- danabeed ka. Ma aha xoogdaga istaabashada

**Dhammaan walxaha Danabeysoni Xoog ayey isku saqaan midba midka kale ;**

**i) Danabyada isku midka ahi way kala boodaan**

**ii) Danayada kala duwani way isa soo jiitaan**

**Tani waa weerka**

**Danabka NeGi**

### **Dananab- Cabiraha Iyo Isticmaakiisa**

Hawlgaladii kala duwanaa ee aan Ku soo Samaynay qeybihii hore, wax aad ku soo Baratay sida loo baadho walxaha danabay san iyo Jiritaan ka labada nooc ee danabyada Korontada

**Danab- cabbiruhu Waa Aalad Ama qalab Fudud oo loo Istic maalo in lagu ogaado Astaamaha danaby ada waxay ina awoodsiisaa in aan ku go'aamino calaama da Danabka iyo laxaadka danabka walaxda**

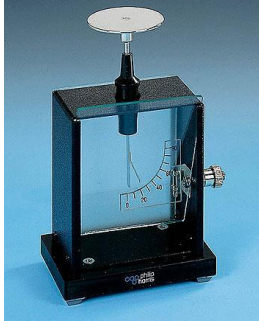

b) Danab-cabire warqada Aluumin amk leh



t) Danab – cabure Deegaanka laga

#### Jaantuska 8.14 Danab- Cabbire

Jaamtisla 8.14 (b) wuxuu ina tusinayaa danab cabbiraha ka samaysan warqada aluuminamk. Wuxuuna ka kooban yahay qotin baraas ah, kaasoo la dul-dhigay madaxa Baraas ta xaggeede sare iyo saxanka Baraasta ah ee xagga salka warqada khafiif ah oo aluuminamah oo ku dhagsan saxanka baraaska ah. qotin Ka bar aaska ah waxaa la dul-saaray bir waxaana lagu taageeray Ama kor loogu qaaday dhidib walax ma gudbiyeeh birtu waxay leedahay daaqaad dhalo ah si ay ugn ogolaato waraaqaha aluuminamka ah in laga Arko

### Isticmaalka danab- Cabbiraha

**Danab- Cabbiraha waxaa loo Isticmaala**

- i. Si luu inoo tuso in danabku ka gudbo Biraha ( Dhexmaro)
- ii. Si loo tijaabiyo in walaxi Danab leedahay iyo in kale
- iii. Si loo baadho calaamada Danabka walaxda sida in la hubiyo in walaxdu leedahay danab taban Ama inay leedahay Danab togan.

#### Hawlgalka 8.14 Baadhida in walaxi leedahay danabiyo in kala

Danabee ul- dhalo ah adigoo ku xoqaya dhar xariir ah. U dhawee u sha danabay san madax Danab cabbirah dhexdhexaadka ah adigoo taabsiinaya caleemaha danab cabbiraha dhexdhexaadka ahi way kala firdhisiin in usha cagaaran ee danabaysan caleemuhu inama tusi doonaan wax qaloocsan ah marka ul Ama Bir aan danabaysinayn loo dhaweeyo madaxa Danab- cabbiraha





Jaantuska 8.15 Qallooc Sanka caleemaha Danab- cabbiraha

### Hawlgalka 8.15 Baadhida Calaamada Danabyada ee walaxda Danabeysan

- Danab- cabbiraha merka koo waad waa in la danabeeyo si loogu Isticmaalo si loo baadho calaamada danabyada ee walax danabaysan. DaNab- cabbiraha Dhexdhexaadka ahi (aan danals lahayn) inaga caawin mayo in aan helo ama Baadhno calaamada Danabka ee walaxda Danabay san.
- Ku Danabee. Danab taban Danab- cabbiraha Adigoo taabsiinaya madaxiisa ul-leh Danab taban Dabadeed, U dhawee walax ama Bir kale oo aan la Aqoon calaamada Danabkeeda adigoo taabsiinaya Madaxa Danab- cabbiraha
- Haddii kala firidhsanaanta caleemuhu kordhaan, waxaan Ku soo Gabagabay n karnaa in walaxda Ama usha loo dhaweeyey ay leedahay calaamad (-) la mid ah ta Danab- cabiraha Laakiin haddii kala firidhsa naantii hore ee caleemuhu ay hoos u dhac do marka walaxda aan danabkeeda la garanayn la garab dhigo danab- cabbiraha, dabadeed calaamada walaxda Danabkeeda aan la garanayni waa lidka la danab- cabbiraha (+)

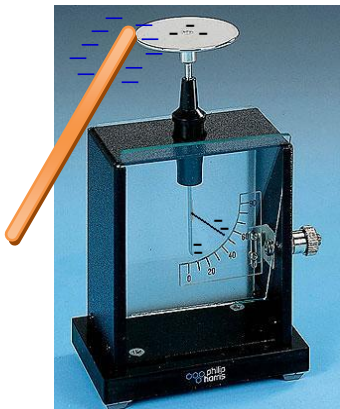

b) Danab cabbire danabaysam

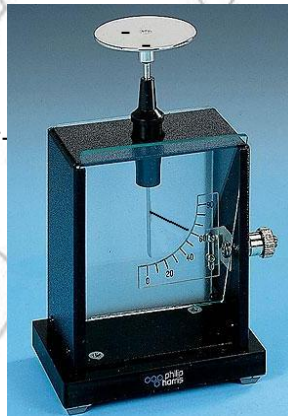

t) sidoo kale qotin danabaysan ayaa sababa in danab cubbiruhu kor dhiyo leexinta

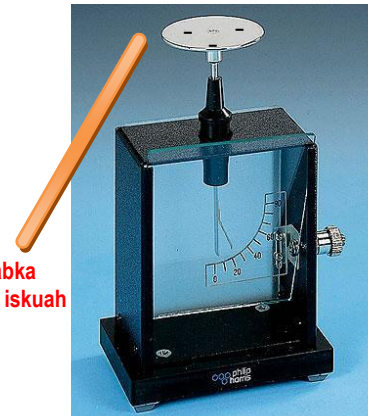

j) hidfotimo danabaysan ayaa sababa in danab cabbiruhu Dhimo qallooc sanka

Jaantuska 8.16 Baadhida calaamada danabyada ee walaxda danabaysan

## Mashruuc shaqo : Sameynta danab cabbira

### Qalabka loo baahan yahay

- Firmirads yare e dewads oo leh fur caag ah
- Warqad ka samee laxaamad sida warqadda ku jirta baakeetka sigaarka
- Kadhog may ah

### Habka laraacnyo

1. Qalooci xadhiga maarta ah, adigoo ka qaloocinaya hal dhinac
2. Quraarada ( dhalada ) furkeeda kudalooli xadiga maarta kadibna kuriix
3. Kuxidh warqada naxaasta ah silig
4. kuxidh quraarada (dhalada) kor keeda xadhiga laqaloociyey? kaniwaa danab cabbiraha laga samay yey degaanka
5. Isticmaalka danab cabbiraha si aad U sharaxdid isticmaalada danab cabbiraha  
Tusaale ahaan walaxad keeni kartaa walax aan danabaysneyn meel udhaw koofiyada togani ama tabane danabka danab cabbiraha Maxaad u maleyneysaa inun kudhacayo caleemaha Miyey caleemuhu dhimayaano ama kordhinayaan firdhinta

### Hawlgalka 8.16 Dhamaystir shaxda soo socota adigoo fiirinaya tigaatinaya walaxda danabaysan iyo fa aan danabaysnayn

Danabka danabcabbiraha	Danabka walax aan la garanayn	Caleenta fitdhinta kordhin
-	-	kordhin
-	+	dhimid
<b>Dhexdhexaad</b>	-	<b>Dhimid</b>
+	+	
+	<b>Dhex dhexaad</b>	
	<b>Dhex dhexaad</b>	

Kordhinta firdhinta caleentu waxay dhacdaa marke danabka danabcabbiraha iyo walaxda danabaysani ay lee yihiin calaamad danab is knmid ah dhimids firdhinta ee caleentu kaliya masheegayso in walaxda iyo danab cabbirhu ay lee yihiin lid danab, laakin walaxdn waxay noqon kar taa midaan danabaysneyn sidaas darteed tijaabada ugu fiican calaamadaha danabka walax waa kordhind firdhinta caleemaha

### Hawlgal 8.17 yjaka siie qakab jabafad, magnd bi gdiga oo istic maalaya danab cabbiraha

Qalabka gaarka ah ee aan adeegsanyno : danabcabbira ha iyo falabyokale dniwas

Habka laraa cayo ama loofabanys farshahan garka ah : danabed danab cabbirahu ha ahaado togane ama tabane Kaqabo qalabyo kala duwan si loo tijaabiyo gacantaada hordhig koofiyada danab cabbiraha xusuusnow qalabku aha xusuusnow fgalbkn madanaboobine

Haddin ay calkemuhu sikadis ah u bur- buraan qalabku waa gndbiyc fican Maxaa yeeay danab danab eabbiru hun a dhaxmaraa gudbiyaha laa gacantaada Haddii ay caleentu sidii marki hore firdhiso qalabku waa magudbiye maxaaayeeleey danabka ka danabcabbiruhu uma gudbiye Magudbiyaha ilaa gaantaada gudbiynhu miyuu danaboobo? Sidi aad bogii hore aad ku soo aragtey magudbiyeyaashu waa sida muraayad caaga qodinka lwm si fudud bay gudbiyuhu danaboodi keraan gamdbouapxjm wmm dama bpbpo laraa aaln haakinn si fudud nma danaboobi karo si da magudbinyaha danabka gudbiyuhu Wuxuu kufaafaa gudihinsa ama Jidh kiisa Haddii aad taabatid danabkn wuxuu dhexmareyaa gacantaada. Haddi aad kajartid danabka socoda walaxda waxaad gudbiye ahaan U Istimaaali kartaa danab magudbiye ah kaas oo kuna caawinaya gudbiye ahaan tusaale sida qodin bir ah ee danab cabbiraha marka nn danaboob waxaa loo isticmaali karaa in lagn danabeeyo qalab magudbiyaha ah sida caaga

### 8.7. Qulqul ka danabka iyo tamar kayid is dheerda

Qeybin hore 8.6 waxaad kusoo baratay Astaamaha danabeeynta negi. Qaybtan waxaad kubarand toontaa astaamaha danabaynta socod

#### Hawlgalka 8.18

- i. Waa maxay qul qulka danabku?
- ii. Wada falanqeyya waxa sameeya qul- qulqulka dhexmaraya xadhiga

### Qul qulka danabka

Marka Laba walxood oo calaamad danabkoodu lid isku tahay lagu xidho gudbiye bir ah qul qul danab ayaa samaysma elektaroonaduna waxay u soconayaan sidan waxay ka tagayaan dhinac walax leh danabyada taban waxayna u socnayaa dhinac walaxda danabkeedu togan yahay socod kana waxaa loo yaqaanna qulqulka danabka

**Qul qulka danabka waa saamiga qul qulka danabaysan iyo xadega dhexmaray sekankiiba**

$$\text{Qul qulke danab} = \frac{\text{danabkasocda}}{\text{a min taaykuqaadato}} \Rightarrow I = \frac{Q}{t}$$

**Marka I = qul qulka danabka**

**Q = xaddiga danabka**

**t = Aminta**

Halbeega caalaniga ah ee qulqulke danabka waa ( Ampere ) ( A ) Halkii Ambeer wuxuu be mid yaha kuulam oo dhaqaatey hal seken qulqulka danabka waxaa lagu cabbiraa amintana waxaa lagu cabbiraa seken (s)

$$1A = \frac{C}{s}$$

1 milliampere = 0.001A

1 microampere = 0.000001A.  $\mu$  (M, waa xaraf girik ah)

qulqulka danab ka waxaa lagu cabbiraa qalab ka layidhaahdo Ameter qul qulka danabka ee gadbayaa ma' aha mid la arka karo Waxaan agsoonahay inay saameeyan qulqulka danabka kuleeyihiin, birlabdanab eey I, W.M

### Tusaale 1

1. Danab dhan 120 C ayna dhexmara danab gudbiye mudo 1 seken

Sinn	Waydiin	Fur furis
$Q = 120 C$	$I = ?$	$I = \frac{Q}{t}$
$t = 1$ Dqiiqadood = 60 ose		$I = \frac{120C}{60s} = 2A$
		Sidaas dardard I = 2A.

2. Danab intaa leg ayaa dhexmaraya danab gudbiye leh qulqul danab 1.5A kaas oo ku dhexmarayo 2 daqiiqe

Sii	Waydiin	Fur furis
$I = 1.5 A$	$Q = ?$	$Q = It$
$t = 2$ dafiqo		$Q = (1.5A) (120s)$
$t = 120$ Seken		$Q = 180 C$

### ilaha tamar isdheerida

#### Hawlgalka 8.19

- i. Sharax waxyaabaha sababa in aybiyuhu n qulqulaan laan meel sare ayagoo idea meel hoose qasaba dhexdeeda
- ii. Sharax muhimada ay yledahay tamarta nagi socodka biyaha.

Tamar kayd isdheerida dhaxaysa labada meelood sabab biyuhu inay ka gudbaan sido kae danabku waa u gudbi sababto ah tamarkagd isdheerida u dhaxaysa labada danab

Waxan arkay naa qul-qulka danabka ka gudbaga gudbiyaha danabka dhexmaraya gudbiyaha isha tamarta u dhaqaajinaysa laa barta looga baahan yahay ilaha caadigah ee tamarkayd isdheerid waa unuga danabka iyo Jan'neetarka (Matorka). Bag tarigu waa iskutaga laba iyo wixii ka badan oo unuggo danabah waa ilaha caadiga ee laga helo tamar kayd isdheeri

- Isha tamarkayd isdheeridu way
- Halbeega tamarkayd isdheeridu waa foolt ( volt (v)
- Qalabka lagu cabbiro isticmaalka tamar kagd isdheerdu waa foolt miter ( as-aasiga)

## Duubka hore iyo duubka dambe

### Hawlgalka 8.20

Kaso gaad unugyo ingagen deegaantiina baro nocyadoda iyo heerkooda tamar kayd is dheerida midwalba.

Dhamaan ilaha tamar kayd, waxaa si balaadha loga helaa unugyada kimikaad unugyada kimikaad waxa lo badalaa tamar kimikaadna tamar danab. iyada elektirikadu waa laba nooc duubka hore (primary cell) duubka dambe (secondary cell)

1. Duubke hore (as-aasiga) waa unugya so saara danabka sida natijada kimikaad u badasha meesha udhaxay sa kala duwanaashahoda mar waxaa lo isticmaalaa dhamaystirka oon mar labaad ahaagn tusaalaha kani waa unuga engagan. Unga engagani waxa uleeyahay laba dacal oo kaliah '+' iyo Tamar kayd isdheerida u dhaxaysa labada cidhifi waa 1.5V (1.5 fool) laba ama inka badan unugyada engagan waxa lo taxaa si is dabagaalah si u'usaa saaro tamar kayd badan sadax unugyo engagan oo lo taxo isdaba yaa waxag noqon 4.54
2. Unuga ( labad (secondarg cell) waa a danabeey gaa iyago la isticmaalayo labadan tusaale ha ugu way muhimsan ee Noocami waa baytariga baabuurta waxa kalo lo yaqaan kaydiaha unuga am ururiyaha

### Hubin 8.7

1. Waa maxay Qul-qul ka danabku?
2. Qor qaar ka midah laha Tamar kayd isdheerida?
3. Waa maxay farqa udhe xega unug as-aasiga igo unuga labaad?
4. Qul qulka danabka 90mA (miliAmper) ayaa ku gudbay 150 sekan. Waa imis a xadiga Dana bee gudbay?

## 8.8. Mareegta Danabka

Mareegta Danabtu waxay u baahan tahay in ay u baqoosho meel ilaa meel mareegta fududi ayaa lag rakibaa tamar kagd aalad iyo daarre damage xubna han waxaa la isugu xidhi waayiro? Eeg jan 8.17

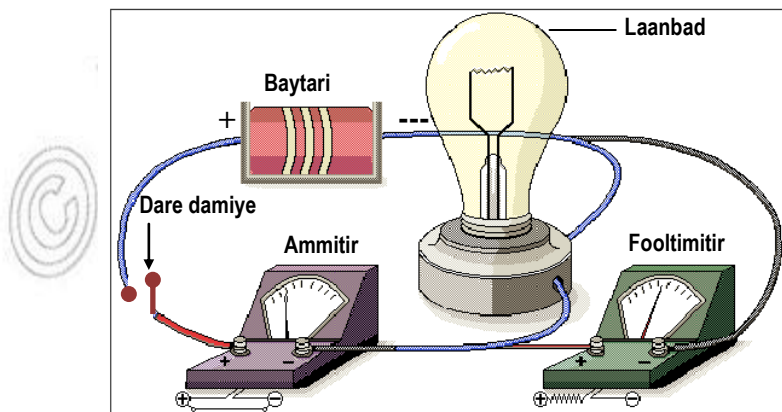

Jaantuska 8.17 Mareegta Danabka

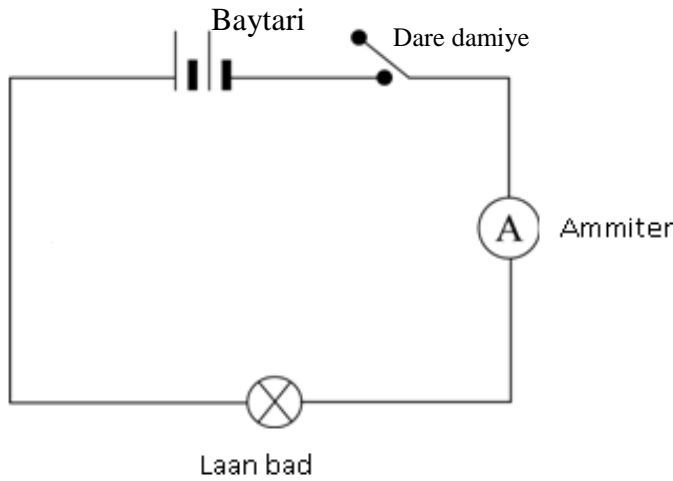

Jaantuska 8.18 Qul- qulka danabka iyo sumadihisa oo sawiran

Dhag yada	Summada
Daare damiye	
Baytari	
Laanbad	
Caabi	
Amiter	
Fooltimeter	
Waayirka gudbiya	
Waayiro xidhildhsan	
Unug	

Jaantuska - 8.19 synnada waetaxa ha ee mareefta Danabka

### Jihda Qul-qulka Danabka

Qul-qulka danabku waxa u lee yahay Jiho’u socodo qul-qulka danabku Jihadan waxa noogada saxarada danabka ee dhexmarage maregta. Ka sooqaad cidhifka dan be ee gud bigaha waxa lagu xidhi labad dactal ee ilahatamar kagdisdheeri elektironada xortaah ee gudbigaha dhexmaraga tabanaha una gud baya toganaha daalaa ilaha gudbigaha

**Qul-qulka Danabk** waa socod ka elektiroonada dactalka taban una soco da dactalka toga nee isha . Jihada qul-qulka danabku waa ji hada elektironadu ay U hagaamaan siday dooni hanoqotee intaa n la daah Furin kohor waxa lo haystag saxaro socoda tani waxa a haayd tilmaan korontadu socodkeedu danabka togan dhinaca danabka taban dactalkiisa.

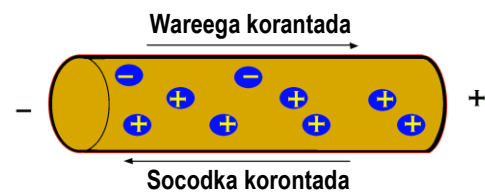

Jaantuska 8.20 Jihada Qul-qulka Danabka

### Korontada noocan ah waxaa layidhaa hdaa wareega koron tada

Jihadani waa lidka elektronaa marka wareega korontadu waa Jiho laisku waa faqo ee qul-qulka danabka Jihada korontadani waa Joogto istic maalkedu buugag ta kale ee fiisigiska sidaas bay udhigaan.

### Gudbiyaha iyo ma gudbiyaha

Gudbiyuhu waa shay kasamaysan atom waxaana ku badan elektirono xor ah elektironada xorta heer tamerka sare baa laga helaa si xor ah bay u socdaan sabab waxay ka fog yihiin bu'da sidaas awgeed socodka danabka (elektironad) waxaay kagudbayaan gudbiyaha.

Gudbiye waa shayga qul-qulka danabku dhexamaro. Waxaa ka soo hor Jeeda gud biyaha magudbiye ma gudbiy uliu waxuu teeydhay inyar oo elektirono xor ah mar ba socodka danabku heduu uxadaysan yahay Magudbiye waa shayga aan gudbin qul-qulka danabka habayaraatee mareegta Fudud isticmaalkedu waa hubinta shaygan gudbiyaha ama magud biyaha.

### Hawkgalka 8.21

Tijaabinta inuyay gudbiye ama magudbiye

Qalabka loo bahan gahay Mareegta Fudud ee eh laanbad, waayirxidhidhsan unug engagan shayo bala kuwan kutijaabi tusaale shayo bira ah, loo baco, dhar lwm

*Habka laraacayo*

- 1) Habee mareegta sida jan- 8.21
- 2) Dhig qalabkala duwan baraha udhexeege Bigo T u fiirso waxa ku dhaca laanbada hubi in ay hurtay iyo kale. Buuxi shaxdan soo socota ilaysbixiye iyo ma bixiye

Shayga	ifay	Ma ifin
Caag		
Bac		
Qalab biro ah		
Loox		
dhar		
Biyo		

- 3) ka la cadee shayda ilays ka bixiye dhe gudbige iyo kuwan aan ilagska aan bixin dheh ma gudbiye bigeyaal

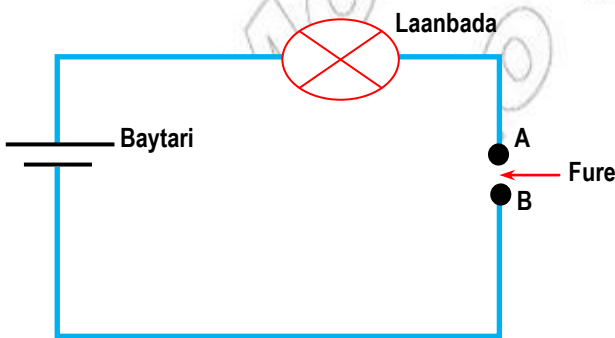

Jaantuskka 8.21 mareeg fu'dud tiJaabo ahaan

### Hubin 8.8

1. Waa maxay qulqulka danabku?
2. Qor walxaha mareegta Fu dud ( sawir mareegta Fudud Summadahn isticmaal)
3. Qeex Gudbiyahaiyo magudbiyaha (Midwalba tusaale ka bixi)
4. Sharax sida loo kalasaa rayo shay-yada gudbiyaha magudbiyaha. .

## Soo koobidda cutubka

### Cutubka waxad ku baratay

- Birlabaha waxaa loo yaqaanaa laba nooc. Birlabtawaxaa loqay bigo Birlabta dadku sameeyo Birlabtu waxay leedahay laba dactal (cidhif) cidhif Ka wagouyl Cidhifka koonfureed? Birlabta cidhifyadeeda lama baabin karo (cidhifgoger- yar lagama dhigikaro) xeerka bir labnimadu waa Cidhi fyada iskumidka way kala didaan cidhifyada kala duwani way isa soo jiitaan.
- Birlabta waan soo saari karnaa lakiin mudo gaaban oo ku meel gaadh ah waxayna ku salaysantahay nooca birta.
- Birlabta sugan ( laad laada0 wa ta layidhaa jiheeye marwalba waxa uuJeeda woqoy-konfur.
- Saamaynta Fallaadhaha birlabta ee dhulka shay-yada birlabtu soo Jida to waxaa layi dhaa birlabgeye shay-yada birlabtu aana sooJi dan waxaa lagidhaa bir- labmagaye .
- Elektriositaati ku waa barashada korontada danabka negi tani waa asaaska barashada elektriksit iga isliskawaxa sababa danabyada ukala gudbaya labada waaxood u kala gudbiya labada waa xod xaaladadanabaznta shay-yada isliska waxa la yidhaa danabku xoqida. Xeerka elektirostiatik waxa u qeexaya danabka iskumidkahi way isa soo jiitaan iyagu.
- Danab-lumintu waa xaaladda lagaga kaxeeyo Danabka tan danabaysan
- Elektiroku waxa u qaadaa danabka taban brotonkan waxau qaada danabka togan nutronku maqaa do danab tanwaxaa la yidha saxarada nutron ka
- Alaabta lagu hubsado danabka waxaa la yidhaa elektirosob barashada danabku waxay loo adeegsadaa elektrosi koob
- Qul- qulka danaku waa saamiga amin tu ugudub to danabka. Halbeega qul-qulka danabku waa Ampere (A) waneega korontada waxay ukala soctaa dhanka toganaha unasocotaa dhanka tabanah dacalkiisa ilaha qul-qulka danabku waxag u kala Socodaan (-) dacalkiis ilaa dactalaa (+) ee ilaha .
- Qul-quldka danabka iyo Fooltegka wa xaa lagu cabbiraa qalabyada la yidhaa Amiter igo fooltimiter. Siisdaba halbeega Fooltegka ama tamar kagd Jaagah is dheeridu waa (volt) Foolt.



## Nakhtinka su'aalaha iyo masaloy in ka

### I. Kuqor run haddi Jumladu saxtahay kuqor Been haddii Jumladu khalad tahay

1. Birlabta cidhifyadeedu marwalba waa lamaane
2. Birta iyo nikalka waa tusaalaha ee aha shayda birlabta
3. Labada dacal ee birlabta waxaa layidhaa cidhifyada Birlabta
4. Labada cidhif ee iskee mid kah way kala didaan
5. Haddii cidhif ka birta usoojito dhuda birlabta hal cidhif markaa waa irbada jiheeyaha

### II. Ka dooro Qaybta 'A' tanku haboon ee Qaybta 'B'

- | A                         | B  |
|---------------------------|--|
| 1. Qul-qulka danabka      | b) Qalabka lagu iisticmaalo walaxda danabysan iyo in kale              |
| 2. xeerka elektirosatitik | t) elektironadu waxay usocdaan dhanka lea + dacalkiisa.                |
| 3. Elektiros iskob        | J) Danabkaisku midku way kala baxsadaan kan kala duwani way is Jiitaan |
| 4. kuulam/sekan           | x) Hakbeegia tanar keyd isdheere                                       |
| 5. Foolt                  | k) Amper   |

### III. Ka dooro jawaabta saxda ah

1. Kuwan sosocda aala de Bir labtu kuJirtaa
 





b) Talafanka	J) radiyo
t) Matoorka danabka	x) dhamaan
2. Midkee bay birlabtu qaba naysaa
 

b) Birtiyo nikilka	t) Balastiga	j) looxa	x) dhamaan
--------------------	--------------	----------	------------
3. Kuwan sosocdo eekaab ahayn Bir – lab magagdo
 

b) Bir	t) nikaa	j) Alumumin
--------	----------	-------------
4. Soojida shadu waxay ku badan tahay
 

b) Dhexda	j) b & t
t) Cidhifika	x) midna
5. Birlabtu waxay ka samay san tahy \_\_\_\_\_
 

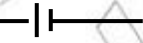
b) bir	j) b&t
t) isteel	x) koo bar
6. kuwaan keebaa tilmaamaya Summada bay tariga ?
 

b) 	j) 
t) 	x) 
7. Kuwan sosocda Qalab kee lagucabiraa Qul- qulka danabka?
 

b) Footimiter	j) elektroiskob
t) Amiter	x) Qul- Qulka danab ka

8. Dahaadhka kee badu danab to gan hadii loo sodhawego danab taban maxaa ku dhic
  - b) Way baea baxsanagaan
  - t) Way isasojida nagaan
  - j) Danabka wag Qabsana gaa dhex dhexaad bag noqon
  - x) Waxba ku dhic maayaan.

#### IV. Buuxu meela ha banana

1. Cidhifyada isku midka \_\_\_\_\_ iyagu ama kuwalkidka iskuahina \_\_\_\_\_ iyaguna .
2. \_\_\_\_\_ waa bir la b dabiciah
3. Birlabta dadku sameeyen waa \_\_\_\_\_ ama \_\_\_\_\_.
4. Waxaan ugu yeedh naa dactalada bir labta \_\_\_\_\_.
5. Qaabka birlabta waxaykalayihiin \_\_\_\_\_, \_\_\_\_\_, \_\_\_\_\_ lwm.
6. \_\_\_\_\_ Shay'yada qul-qulka danab ka gud biya .
7. \_\_\_\_\_ waa saamiga u qul-qulka danabke kagata fayyo bar
8. Dana bagb ta wadaagy waa \_\_\_\_\_.
9. Walaxda layidhaa \_\_\_\_\_ Danabays hadii elektiron aysoqaad to
10. Saxarada atamka unteralka ama dha x dhe xaad ah waxalagidhaa \_\_\_\_\_.

#### V. KaJawaab

1. Sided ku karan dactal ka bir labta ee waqoog?
2. Qeex xeer ka Bir labnimada.
3. Qeybaha ugumu him san ee elektioscobe maxay bal yihiin?
4. Maxa loa jeedaa birlab magay do?
5. Sadax ka sheeg wax yaa baha bir labtu soojida to.
6. Sheeg wax yaabaha aan ku qabsano birlabta noolol maalmed keena.
7. Maxaa lagu cabbiraa b kuu lam t = am per?
8. Waa imisa qul- qulka danabkee marka 10C danabku kata fo muad 2 sekan?
9. Waa imisa danabka gudbaya 4A mu do 3 sekan?
10. Qeex farqa udhexega gudbiye iyo magudbiye?
11. Qaado tooshka amabaro qul- qul fiisa danabka? Sawir mareeg tatoushka.
12. Waa maxay Qaybaha elektro is kob ku- sawir elektiroiskob iyo giyaasaha.
13. Waa maxa faraqa u dhe xega koron tada wareege da iyo Qul-qulka danabka?
14. Side bu danab ku isgu gud baa?
15. Waxaad ogtahay mar kaad feedha nay so timaha waxa gud bay danab timahaaga iyo gar Feeda. Markaad kufeed to kadib waxag danabu?
16. Haddi add marisid baalanka loox ama dhastarka waxaa u dana bayse si tahan danabka siyadadu halkuu kagid?
17. Qeex maxaa dha cag?
  - b) Galaaska lagu xo qag timaha.
  - t) galaaskan isaga ah gacan taada saar.