

# Physics

Student Textbook  
Grade 9

Physics

Student Textbook

Grade 9



# Physics

Student Textbook  
Grade 9



Federal Democratic Republic of Ethiopia  
Ministry of Education

ISBN 978-99944-2-016-2  
Price: ETB 36.00

FDRE  
MoE



Federal Democratic Republic of Ethiopia  
Ministry of Education



# Physics

Student Textbook  
Grade 9

Author: Graham Bone

Advisers: Tilahun Tesfaye Deressu (PhD)  
Endeshaw Bekele Buli

Evaluators: Yosef Mihiret  
Gebremeskel Gebreegziabher  
Yusuf Mohamed



Federal Democratic Republic of Ethiopia  
Ministry of Education

PEARSON

## Acknowledgments

The development, printing and distribution of this student textbook has been funded through the General Education Quality Improvement Project (GEQIP), which aims to improve the quality of education for Grades 1–12 students in government schools throughout Ethiopia.

The Federal Democratic Republic of Ethiopia received funding for GEQIP through credit/financing from the International Development Associations (IDA), the Fast Track Initiative Catalytic Fund (FTI CF) and other development partners – Finland, Italian Development Cooperation, the Netherlands and UK aid from the Department for International Development (DFID).

The Ministry of Education wishes to thank the many individuals, groups and other bodies involved – directly and indirectly – in publishing the textbook and accompanying teacher guide.

The publisher would like to thank the following for their kind permission to reproduce their photographs:

(Key: b-bottom; c-centre; l-left; r-right; t-top)

Alamy Images: GB 9, A1 Canada Photos 65, Alchemy 61, Art Directors and TRIP 117b, B.A.E. Inc 200, Howard Barlow 234c, bljckwinkel 230br, Steve Bloom Images 74b, Bon Appetit 174tl, Chris Cheadle 181, Richard Cooke 114, Design Pics Inc. / RM Content 234tr, Karin Duthie 231, DWImages 198, Michael Dwyer 155, Elvele Images Ltd 144t, Mary Evans Picture Library 174b, Kevin Foy 108, fStop 141c, GIPhotoStock Z 144bl, Mike Goldwater 88t, Digifoto Green 187, Christian Heinrich / ImageBroker 230tr, Images of Africa Photobank 43t, Bjanka Kadie 185b, Lenscap 100t, Bobbie Lerryn 177, Manor Photography 143r, MARKA 20, 111t, Morelease Travel London 133, NASA Images 35, Douglas Peebles Photography 230bl, Reimar 234b, Ivo Roosplod 185c, sciencephotos 174tr, 218c, SCPhotos 125, Jochen Tack 162l, Tetra Images 230tl, The Art Gallery 45t, David Tipling 208, David Wall 234tl, Westend 61 GmbH 106t, Worldspec / NASA 74t, Tony Wright / Earthscapes 31b; Corbis: Colin Garratt; Milepost 92 1 / 2 106b, Dimitri lundt / TempSport 17, NASA / Roger Ressmeyer 60l, Jim Sugar 62, Tetra Images 46b, Ahmad Yusni / epa 143l; Getty Images: 219, AFP 56b, 58, AFP 56b, 58, Malcolm Fife / Photographer's Choice 179, Gavin Hellier / Robert Harding World 172, Spencer Platt 56t, Science and Society Picture Library 67, Siri Stafford / Photodisc 46t (ball); GNU Free Documentation license: Adrian Pingstone 232; iStockphoto: Yunus Arakon 117t, Dan Barnes 166, Steven Braun 134, Arthur Carlo 70t, Mikael Damier 75, Erik de Graaf 54, Elke Dennis 111b, Oleg Fedorenko 152, Trevor Fisher 173b, Joseph Gareri 55, Jose Luis Gutierrez 107t, Ian Hamilton 38, Adam Hicks 31t, Mark Jensen 107bc, Dan Kite 145b, Knappe 178t, Geoff Kuchera 34t, Kate Leigh 173t, Mario Loiseau 127, Chepe Nicoli 178b, Iain Norman 83, Gregory Olsen 141b, Rhoberazzi 107tc, Lawrence Sawyer 34b, Christy Scott 102t, Mark Sheppard 96, Doug Sims 163, Nicholas Skaanild 135, Richard Stouffer 88b, Stephen Strathdee 100b, Alexandr Tovstenko 102b, Duncan Walker 45b, Don Wilkie 160, Dane Wirtzfeld 53, Vladimi Yudin 107b; NASA: 46t (space); NASA: IPEC 175l, 175r; Rex Features: Burger / Phanie 141t; Science Photo Library Ltd: Dr Jeremy Burgess 64t, Mark Burnett 185tl, Chris Butler 43b, D.Roberts 218t, Bernhard Edmaier 109, European Space Agency 44, Adam Hart-Davis 47, Gary Hincks 19, Edward Kinsman 227, Mehau Kulyk 43c, Andrew Lambert Photography 49, 50, 64b, 225t, 225b, Louise Murray 162r, NASA 60r, NOAA 145t, David Nunuk 167, Sam Ogden 146, Pekka Parviainen 226, Royal Astronomical Society 144br, Erich Schrempp 223, Zephyr 237

Cover images: Front: Corbis: Dimitri lundt / TempSport br; iStockphoto: GB/Alamy tr; Science Photo Library Ltd: Andrew Lambert Photography l

All other images © Pearson Education

Every effort has been made to trace the copyright holders and we apologise in advance for any unintentional omissions.

We would be pleased to insert the appropriate acknowledgement in any subsequent edition of this publication.

© Federal Democratic Republic of Ethiopia, Ministry of Education

First edition, 2002 (E.C.)

ISBN: 978-99944-2-016-2

Developed, Printed and distributed for the Federal Democratic Republic of Ethiopia, Ministry of Education by:

Pearson Education Limited

Edinburgh Gate

Harlow

Essex CM20 2JE

England

In collaboration with

Shama Books

P.O. Box 15

Addis Ababa

Ethiopia

All rights reserved; no part of this publication may be reproduced, stored in a retrieval system, or transmitted in any form or by any means, electronic, mechanical, photocopying, recording, or otherwise without the prior written permission of the copyright owner or a licence permitting restricted copying in Ethiopia by the Federal Democratic Republic of Ethiopia, Federal Negarit Gazeta, *Proclamation No. 410/2004 Copyright and Neighboring Rights Protection Proclamation, 10th year, No. 55, Addis Ababa, 19 July 2004.*

Disclaimer

Every effort has been made to trace the copyright owners of material used in this document. We apologise in advance for any unintentional omissions. We would be pleased to insert the appropriate acknowledgement in any future edition

Printed in Malaysia (CTP-VVP)

# Contents

---

<b>Unit 1 Vectors</b>	<b>1</b>
1.1 Representation of vectors	1
1.2 Addition and subtraction of vectors	3
1.3 Some applications of vectors	10
<b>Unit 2 Motion in a straight line</b>	<b>15</b>
2.1 Uniform motion	16
2.2 Uniformly accelerated motion	19
2.3 Graphical description of uniformly accelerated motion	22
2.4 Equations of uniformly accelerated motion	28
2.5 Relative velocity in one dimension	36
<b>Unit 3 Forces and Newton's laws of motion</b>	<b>42</b>
3.1 Forces in nature	43
3.2 Newton's second law	52
3.3 Frictional forces	64
3.4 Newton's third law	71
3.5 Conservation of linear momentum	74
3.6 Collisions	83
3.7 The first condition of equilibrium	84
<b>Unit 4 Work, energy and power</b>	<b>87</b>
4.1 Mechanical work	88
4.2 Work–energy theorem	96
4.3 Conservation of energy	101
4.4 Mechanical power	110
<b>Unit 5 Simple machines</b>	<b>116</b>
5.1 Purposes of machines	116
5.2 Inclined plane, wedge and screw	124
5.3 Levers	128

<b>Unit 6 Fluid statics</b>	<b>140</b>
6.1 Air pressure	141
6.2 Fluid pressure	151
<b>Unit 7 Temperature and heat</b>	<b>171</b>
7.1 Temperature and heat	172
7.2 Expansion of solids, liquids and gases	179
7.3 Quantity of heat, specific heat capacity and heat capacity	191
7.4 Changes of state	199
<b>Unit 8 Wave motion and sound</b>	<b>207</b>
8.1 Wave propagation	207
8.2 Mechanical waves	214
8.3 Properties of waves	221
8.4 Sound waves	228
<b>Index</b>	<b>241</b>

© MOE, FDR Ethiopia  
Not to be republished

Contents	
Section	Learning competencies
1.1 Representation of vectors (page 1)	<ul style="list-style-type: none"> <li>• Define the term vector.</li> <li>• Give some examples of vector quantities.</li> <li>• Represent vectors both analytically and graphically.</li> </ul>
1.2 Addition and subtraction of vectors (page 3)	<ul style="list-style-type: none"> <li>• Define the term resultant vector.</li> <li>• Add two vectors together (including vectors in the same direction, opposite directions and at right angles to each other).</li> <li>• Determine the angle of a resultant vector.</li> <li>• Use Pythagoras's theorem to determine the size of the resultant vector.</li> <li>• Resolve a vector into horizontal and vertical components.</li> <li>• Find the direction and resultant of two or more vectors using the component method.</li> </ul>
1.3 Some applications of vectors (page 10)	<ul style="list-style-type: none"> <li>• Define the term equilibrium.</li> <li>• Explain the importance of forming a triangle of three vectors.</li> <li>• Carry out some experiments to investigate vectors.</li> </ul>

Whenever you take a measurement of an object you are recording a physical property of that object. Further physical properties can then be calculated using these measurements. All physical quantities are either scalar or vector quantities. This unit looks at vectors in detail, including examples of vectors, how to add them up and why they are used. Vectors are crucial in a wide range of applications, from landing on the Moon to crossing rivers and to keeping bridges standing up!

## 1.1 Representation of vectors

By the end of this section you should be able to:

- Define the term vector.
- Give some examples of vector quantities.
- Represent vectors both analytically and graphically.

### What are vectors?

If you were asked for directions to your house, simply saying '6 km away' would not be very helpful. Instead you need to provide more information. Along with the distance a direction is also required. Saying '6 km due North from here' provides much

**KEY WORDS**

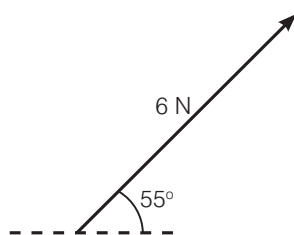
**scalar** a quantity specified only by its magnitude

**magnitude** size

**vector** a quantity specified by its magnitude and direction

**Think about this...**

Magnitude is a scientific way of describing the size of a quantity. For example, a velocity of 50 m/s North has a magnitude of 50 m/s. Scalars are quantities that have a magnitude only.



**Figure 1.1** An arrow representing a force of 6 N at about 55° to the horizontal.



**Figure 1.2** Two different displacement vectors, represented by arrows.

**DID YOU KNOW?**

Vectors, as they are understood today, first appeared in a publication called *Vector Analysis* by the American J. W. Gibbs in 1881.

more information. You have provided a **magnitude** (6 km) and a **direction** (North). Quantities that have both a size and a direction are referred to as **vectors**.

Vectors are incredibly useful tools in both mathematics and physics.

- A vector quantity has both magnitude and direction.

The alternative, a **scalar** quantity, just has magnitude (size) and there is no direction associated with it. For example, it would be silly to say a chemical energy of 600 J North! Energy is an example of a scalar quantity.

All vector quantities have a direction associated with them. For example, a force of 6 N to the left, or a displacement of 45 km South.

**Table 1.1** Some examples of vector and scalar quantities

Vector quantities	Scalar quantities
Forces (including weight)	Distance
Displacement	Speed
Velocity	Mass
Acceleration	Energy
Momentum	Temperature

**How can we represent vectors?**

As all vectors have a direction, we must include one when writing them down. For example, a displacement of 13 km would not be enough information. We must write 13 km South West.

We usually represent vectors using arrows. The length of this arrow represents the size of the quantity and the way it is pointing represents its direction.

Notice in Figure 1.2 that the 50 km vector is twice the size of the 25 km vector.

We often represent vector quantities in equations using bold type or with an arrow above the quantity. For example, to represent force we might write  $F$  or  $\vec{F}$ . So an important equation like  $F = ma$  would be written as  $F = ma$  or  $\vec{F} = m\vec{a}$  as both force and acceleration are vector quantities.

Vectors and scalars should not be confused with SI units.

The International System of Units (SI) defines seven basic units of measurement. These may be seen in Table 1.2 at the top of the next page and all have very exact definitions. For example, the second is defined as the duration of 9 192 631 770 periods of the radiation corresponding to the transition between the two hyperfine levels of the ground state of the caesium-133 atom!

All other SI units are derived from combining one or more these units. For example, the newton is the SI derived unit of force, 1 N is equivalent to 1 kg m/s<sup>2</sup>.

**Table 1.2** Some quantities, their units and whether they are vectors

Quantity	SI Unit	Vector or Scalar
Mass	Kilogram (kg)	Scalar
Length	Metre (m)	Sometime scalar (distance) sometime vector (displacement)
Time	Second (s)	Scalar
Temperature	Kelvin (K)	Scalar
Amount	Mole (mol)	Scalar
Electric current	Ampere (A)	Vector
Luminous intensity	Candela (cd)	Scalar

### Summary

In this section you have learnt that:

- All physical quantities are either vectors or scalars.
- Vector quantities have both a magnitude and a direction.
- Vectors must include a direction.
- Arrows are used to represent vectors.

### Discussion activity

Come up with a list of at least 15 physical properties. Discuss these with your partner and decide if they are scalar or vector quantities. Combine your pairs to form groups of six. Discuss any quantities you are unsure of.

### Review questions

1. Give four examples of vector quantities.
2. Explain how vectors differ from scalars. Give some examples.
3. Draw, to scale, three different sized forces acting in different directions. Label them with their size and direction.
4. Abebe wants to lift a 10 N object from the ground. What is the minimum force he needs to exert (include both the magnitude and direction).

## 1.2 Addition and subtraction of vectors

By the end of this section you should be able to:

- Define the term resultant vector.
- Add two vectors together (including vectors in the same direction, opposite directions and at right angles to each other).
- Determine the angle of a resultant vector.
- Use Pythagoras's theorem to determine the size of the resultant vector.
- Resolve a vector into horizontal and vertical components.
- Find the direction and resultant of two or more vectors using the component method.

### Activity 1.1: Representing vectors using arrows

Choosing your own scales draw arrows to represent three vectors:

- 400 km North East
- 32 m/s at an angle of  $60^\circ$  to the horizontal
- A force with a size and direction of your choosing. Include the scale and then pass this to your partner to determine the size and direction of the force.



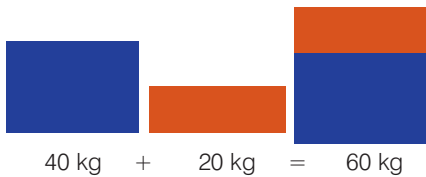


Figure 1.3 An example of adding scalars

**KEY WORDS**

**parallel** running in the same direction at the same constant distance apart as another line or surface

**perpendicular** forming an angle of 90 degrees with another line or surface

**parallelogram method**

**method of resolving multiple vectors**

**resultant** the result of combining multiple vectors

**Think about this...**

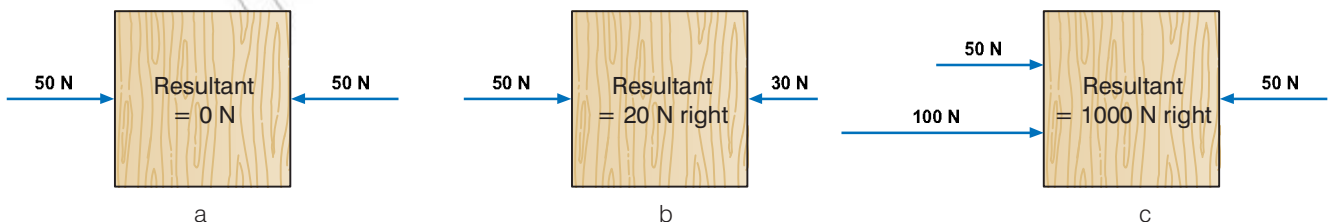
How fast would you have to run on this bus to have a resultant velocity of 0 km/h?

**Activity 1.2: Resultants**

Calculate the resultant displacement for the following:

- 10 km left, 20 km right, 30 km left
- 150 km North, 50 km North, 250 km South
- 7 km East, 14 km West, 13 km West.

Figure 1.6 Adding different parallel vectors (along a line)



**How do we combine vectors?**

Scalars are simple to add. For example, when a mass of 40 kg is added to a mass of 20 kg the total mass is 60 kg.

However, vectors are a bit more complex. When adding two 4 N forces it is possible to get a total of 8 N or 0 N or even 5.7 N!

When you add two or more vectors together the overall vector is called the **resultant**.

**Combining parallel vectors**

The directions of vectors are really important. If you want to add two **parallel** vectors, for example forces of 6 N and 3 N, you could get 9 N or 3 N – as shown below.

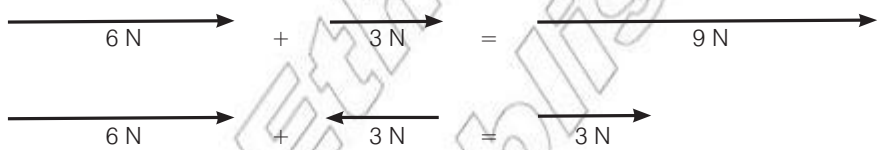


Figure 1.4 Parallel vector additional (along a line). The resultant is 9 N if they are in the same direction but 3 N if the forces are in opposite directions.

You could think of the 6 N as positive and the 3 N to the left as negative (-3 N) as it is in the opposite direction. So:

$$6\text{ N} + -3\text{ N} = 3\text{ N}$$

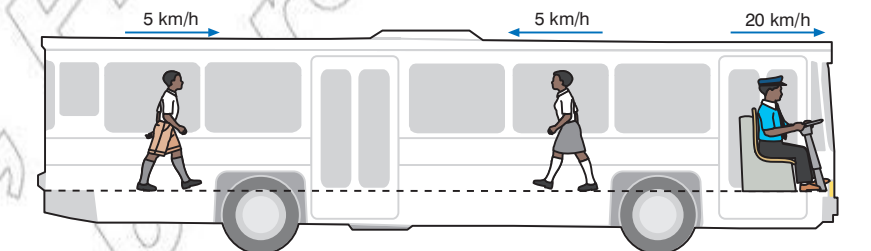


Figure 1.5 Velocity vectors on a bus

This applies to all vectors. A real world example, this time dealing with velocities, can be seen in Figure 1.5. If the bus is moving North at 20 km/h and you get up and walk towards the front of the bus at 5 km/h your resultant velocity is given by:

$$v = 20\text{ km/h} + 5\text{ km/h} = 25\text{ km/h North}$$

If you then turn around and walk to the back of the bus your velocity would be 15 km/h North.

Some other examples involving forces can be seen below.

If you have several parallel vectors, the resultant may be found by adding all the vectors in the same direction and subtracting those going in the opposite direction. This can be seen in Figure 1.6c.

### Combining perpendicular vectors

But what if the vectors to be added are not parallel?

For example, think about a swimmer swimming from one river bank to another. He swims across the river **perpendicular** to the river bank at 2.0 m/s. However, the river is flowing parallel to the river bank at 1.0 m/s. How can you find his resultant velocity?

One method is referred to as the **parallelogram method**. This involves drawing the two vectors with the same starting point. The two vectors must be drawn to a scale and are made to be the sides of the parallelogram. The resultant will be the diagonal of the parallelogram.

#### Worked example

1. Choose a scale of 5 cm to represent 1 m/s.
2. Draw the vectors to represent the different velocities of the man starting at the same point.
3. Complete the parallelogram (which in the case of perpendicular vectors is always a rectangle).
4. Draw the resultant vector diagonally across the parallelogram, from A to C (this represents the resultant velocity of the swimmer).
5. Measure the length of AC and convert into m/s. It should be around 11.25 cm long, and this is equivalent to 2.25 m/s (using 1 m/s is 5 cm). The angle from the river bank should be measured as around  $64^\circ$ .

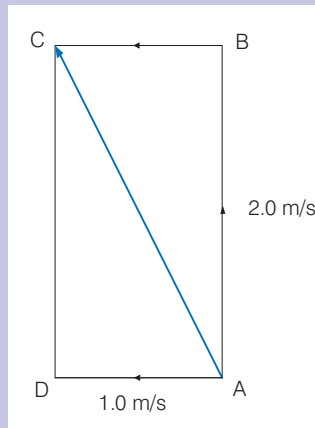


Figure 1.8 The resultant velocity.

### Pythagoras's theorem

The square of the hypotenuse of a right-angled triangle is equal to the sum of the squares on the other two sides.

#### Discussion activity

What are the advantages of the parallelogram method over using mathematics to solve vector problems?

#### Discussion activity

What is your total displacement during the school day? You begin the day by getting out of bed, and end it by returning to bed.

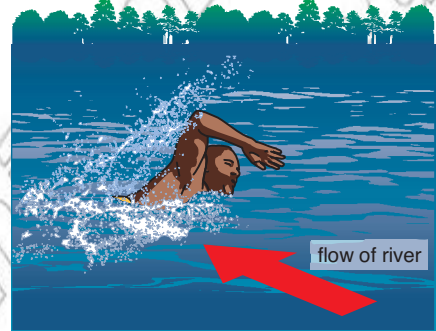


Figure 1.7 Obang going across Baro River

#### Activity 1.3: Using the parallelogram method

Using the parallelogram method, determine the resultant vector in each case:

- 10 km left, 20 km up
- 150 km North, 50 km West
- 7 km East, 14 km North

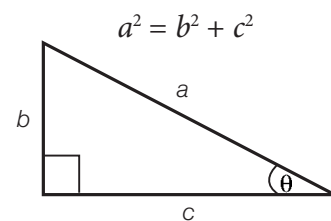


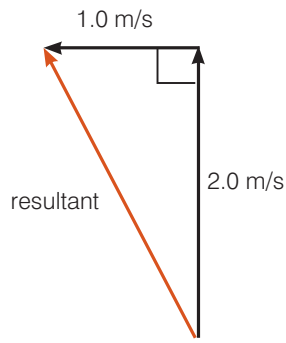
Figure 1.9 A right-angled triangle

#### DID YOU KNOW?

Pythagoras (or to give him his full name, Pythagoras of Samos) was born in ancient Greece around 570 BC. That's over 2500 years ago!

**Think about this...**

The opposite side is so called because it is opposite the angle.

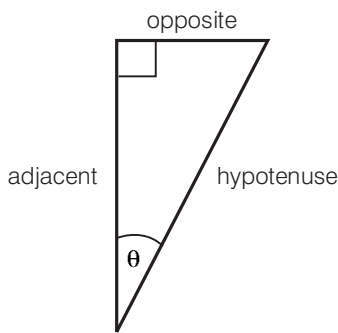


**Figure 1.10** The swimmer's velocity vectors shown as a right-angled triangle.

$$\sin \theta = \frac{\text{opposite}}{\text{hypotenuse}}$$

$$\cos \theta = \frac{\text{adjacent}}{\text{hypotenuse}}$$

$$\tan \theta = \frac{\text{opposite}}{\text{adjacent}}$$



**Figure 1.11** Terms used in trigonometry

An alternative to the parallelogram method involves using **Pythagoras's theorem** to determine the size of the resultant vector. Trigonometry can then be used to find its direction. This gives a much more precise answer.

Looking again at the swimmer example, a quick sketch of the vectors can be seen in Figure 1.10.

Because the vectors are perpendicular, they form a right-angled triangle. The resultant is the **hypotenuse**, so using Pythagoras's theorem we get:

$$a^2 = b^2 + c^2 \text{ State principle or equation to be used (Pythagoras's theorem)}$$

$$\text{resultant}^2 = 1.0^2 + 2.0^2 \text{ Substitute in known values}$$

$$\text{resultant}^2 = 5.0 \text{ Solve for resultant}^2$$

$$\text{resultant} = \sqrt{5.0} \text{ Rearrange for resultant (take square root) and solve}$$

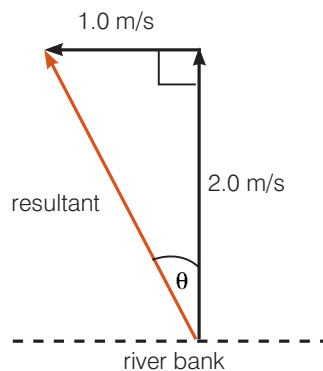
$$\text{resultant} = 2.24 \text{ m/s (to 3 sig fig) Clearly state the answer with unit}$$

This method may be used for any two perpendicular vectors.

However, we are missing the direction – all vectors must include a direction.

**Trigonometry**

Looking back at our simple diagram.



**Figure 1.12** The swimmer's velocity vectors shown as a right-angled triangle including the river bank.

Using trigonometry, we can determine angle  $\theta$ . As we have the side **opposite** the angle (1.0 m/s) and the side adjacent to the angle (2.0 m/s) we should use:

$$\tan \theta = \frac{\text{opposite}}{\text{adjacent}} \text{ State principle or equation to be used (trigonometry)}$$

**KEY WORDS**

**hypotenuse** the side of a right-angled triangle opposite the right angle

**opposite** the side of a right-angled triangle opposite the angle being calculated

**Pythagoras's theorem** theorem for calculating the angles and length of the sides of a right-angled triangle

**right angle** an angle of 90 degrees

$$\tan \theta = \frac{1.0}{2.0} \text{ Substitute in known values}$$

$$\tan \theta = 0.5 \text{ Solve for } \tan \theta$$

$$\theta = \tan^{-1} 0.5 \text{ Rearrange equation to make } \theta \text{ the subject and solve}$$

$$\theta = 26.6^\circ \text{ Clearly state the answer with unit}$$

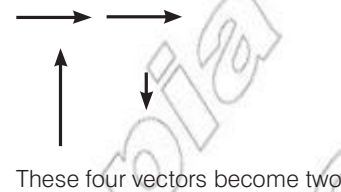
This means the angle between the resultant velocity and the river bank is given by  $90^\circ - 26.6^\circ = 63.4^\circ$ .

Both methods give nearly identical answers; the mathematical method offers more precise values.

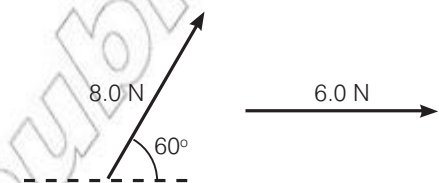
**Table 1.3** Comparing mathematical and diagrammatic methods for finding resultants

	Parallelogram method	Mathematical method
Size	2.25 m/s	2.24 m/s
Direction	$64^\circ$	$63.4^\circ$

If you have more than two perpendicular vectors you add up the parallel ones first leaving you with two perpendicular vectors from which you can determine the resultant.



**Figure 1.13** Combining more than two vectors



**Figure 1.14** Non-parallel and non-perpendicular vectors (in this case forces)

## Non-parallel and non-perpendicular vectors

So we can now add parallel vectors and perpendicular vectors, but what if the two vectors to be added are not parallel or perpendicular? An example of two forces can be seen below.

We could use the parallelogram method, as before. This can be seen below, but notice that as the vectors are not perpendicular the parallelogram is not a rectangle.

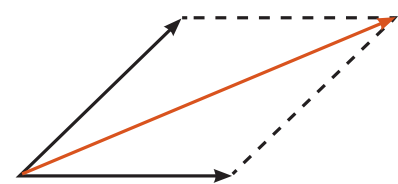
The size and the angle of the resultant could then be measured directly. But what if we wanted to find a more precise, mathematical answer?

Draw the two vectors from the same origin. A diagonal passing through their origin describes their resultant.

## Trigonometry

$$\text{hypotenuse} \times \sin \theta = \text{opposite}$$

$$\text{hypotenuse} \times \cos \theta = \text{adjacent}$$



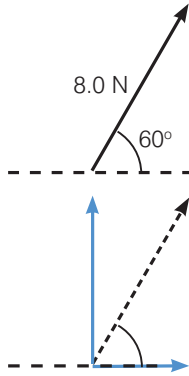
**Figure 1.15** Parallelogram method for non-perpendicular vectors

## Resolving vectors

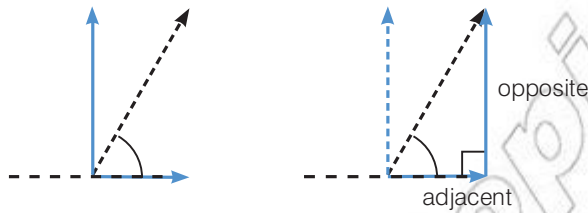
In order to solve the problem mathematically we need to **resolve** one of the vectors. Resolving means splitting one vector into two component vectors (usually one horizontal and one vertical). These components have the same effect as the original vector. This process is almost the reverse of combining two perpendicular vectors. An example can be seen on the next page in Figure 1.16; the 8.0 N force can be resolved into two component vectors that when combined have the same effect.

### KEY WORD

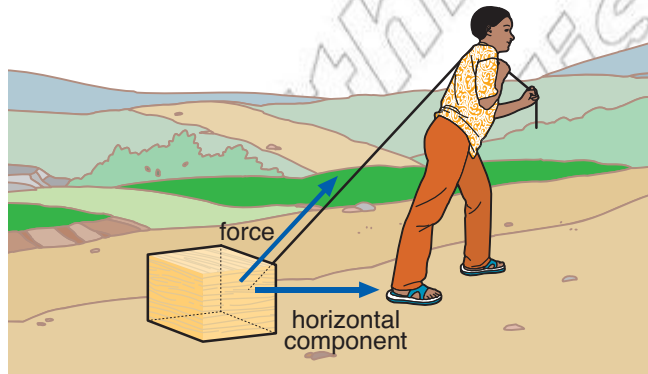
**resolve** to split a force or vector into its horizontal and vertical components



**Figure 1.16** Components shown in blue



**Figure 1.17** Component vectors as a right-angled triangle



**Figure 1.18** This is an example of where resolving forces may be useful. Although the rope is at an angle it is only the horizontal component that causes the box to move.

So working through we get:

- $\text{hypotenuse} \times \sin \theta = \text{opposite}$
- $8.0 \text{ N} \times \sin 60^\circ = 6.9 \text{ N}$ , the vertical component
- $\text{hypotenuse} \times \cos \theta = \text{adjacent}$
- $8.0 \text{ N} \times \cos 60^\circ = 4.0 \text{ N}$ , the horizontal component

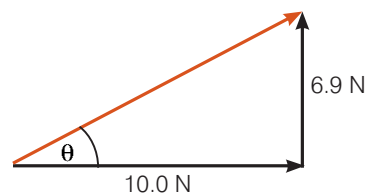
How is this useful?

We now have three vectors to add together; instead of the 8 N vector we have two components.

These can then be added to give 10.0 N horizontally and 6.9 N vertically. Using Pythagoras and trigonometry, the size and direction of the resultant can be calculated as before.



**Figure 1.19** Component vectors to add



**Figure 1.20** Solution: the resultant is 12.1 N at an angle of  $34.6^\circ$  from the horizontal. Check it yourself!



### Activity 1.4: Resultant forces

Mathematically determine the resultant force if two forces, A and B, act on an object. Force A is 85 N and is at an angle of  $20^\circ$  to the horizontal. Force B is 125 N and is at an angle of  $60^\circ$  to the horizontal.

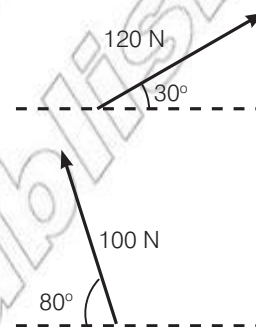
**Figure 1.21** Vectors are really important to pilots in planning their route.

This technique works for multiple vectors at different angles. For example, adding two velocities (this could be the velocities of an aircraft, one due to the direction it is moving the other due to the wind).

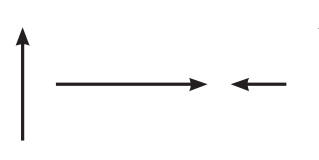
Each of these vectors could then be resolved into horizontal and vertical components. This would give you four vectors to combine.

These could then be added to give two perpendicular vectors. Notice that the horizontal vectors are in different directions and so should be subtracted.

Finally you can use Pythagoras and trigonometry to determine the size and direction of the resultant.



**Figure 1.22** Two vectors at different angles



**Figure 1.23** Four components from the two vectors in Figure 1.22

### Summary

In this section you have learnt that:

- The resultant is the sum of two or more vectors.
- When adding vectors their direction is very important.
- The parallelogram method is a quick and easy way to determine the resultant vector.
- To add perpendicular vectors mathematically you use Pythagoras's theorem to find the size of the resultant and trigonometry to determine its direction.
- Resolving a vector means splitting it into two components.
- Resolving vectors enables you to find the result for vectors at different angles.

### Review questions

1. Calculate the resultant force in each of the examples below.

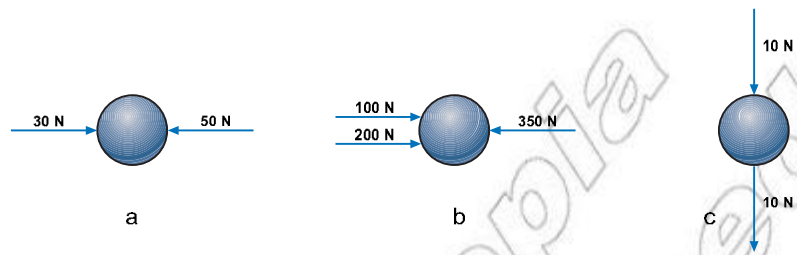


Figure 1.24 Examples for Question 1

2. An aircraft is travelling due North with a velocity of 100 m/s. A strong wind blows from the West with a velocity of 25 m/s. Find the resultant velocity, using both the parallelogram method and the mathematical method.
3. Find the resultant force in Figure 1.22.

### 1.3 Some applications of vectors

By the end of this section you should be able to:

- Define the term equilibrium.
- Explain the importance of forming a triangle of three vectors.
- Carry out some experiments to investigate vectors.

#### What does equilibrium mean?

As well as their importance in navigation (displacement and velocity vectors), force vectors are incredibly important to all buildings and structures. Often huge forces are involved but in the case of a bridge or building there should be no resultant forces acting. If there was, the bridge would move and perhaps topple over.

When there is no resultant force acting on an object it is said to be in **equilibrium**.

This is easy to imagine in one dimension.



Figure 1.25 Forces in equilibrium

The sum of the forces to the left is 12 N. The sum of the forces to the right is 12 N (you could say  $-12$  N). Adding these together gives a

#### KEY WORD

**equilibrium** a state of balance where there are no resulting forces acting on a body

resultant of 0 N. This object is in equilibrium, there is no resultant force acting on it.

In two dimensions this gets a little more difficult. If the vectors are just perpendicular you add up the horizontal forces (those in the  $x$  direction) and these should give a resultant force of zero. You would then repeat the process for the vertical forces (those in the  $y$  direction). If all the forces add up to zero then the object is in equilibrium.

### Scale diagrams

If the forces are not perpendicular then there are two techniques you could use to check if the object is in equilibrium. The first involves drawing a scale diagram.

To do this you simply:

- select a scale for your forces
- draw them to scale, one after the other (in any order), lining them up head to tail ensuring the directions are correct.

If you end up where you started then all the forces cancel out and there is no resultant force (Figure 1.26). However, if there is a gap then there must be a resultant force and the object is not in equilibrium (Figure 1.27).

### Triangle of vectors

If there are only three forces acting, then the scale diagram will always be a triangle if the object is in equilibrium.

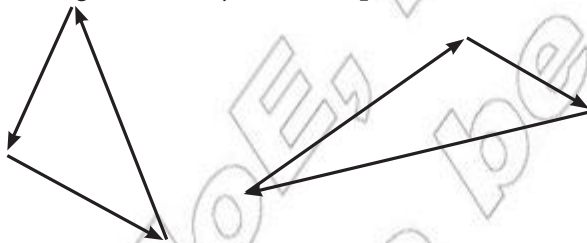
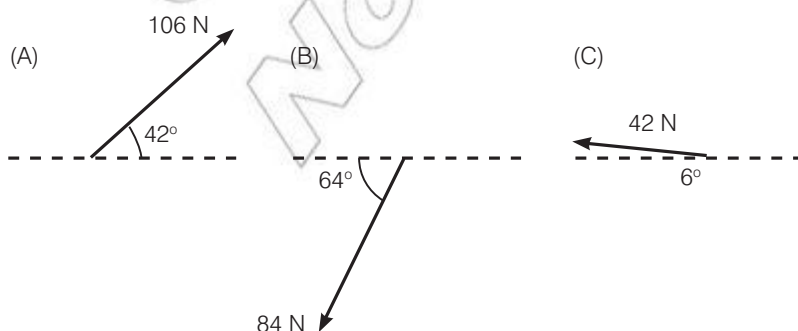


Figure 1.28 Triangle of vectors

### Proving equilibrium mathematically

If you have several forces you can check they are in equilibrium mathematically.

Take three forces below.



### DID YOU KNOW?

When in equilibrium, all the horizontal forces (those in the  $x$  direction) must add up to equal zero. This can be written as:

$$\Sigma F_x = 0$$

$\Sigma$  means 'sum of'. So this literally means that the sum of all the forces in the  $x$  direction is zero.

The same is true for the vertical forces (those in the  $y$  direction). This can be written as:

$$\Sigma F_y = 0$$

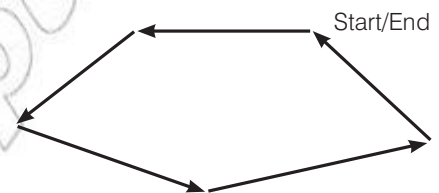


Figure 1.26 Scale diagram showing no resultant force

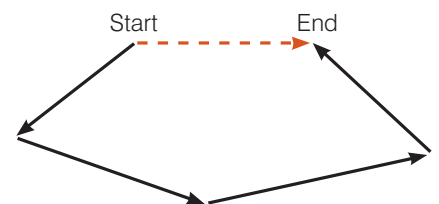


Figure 1.27 Scale diagram showing a resultant force (the red arrow)

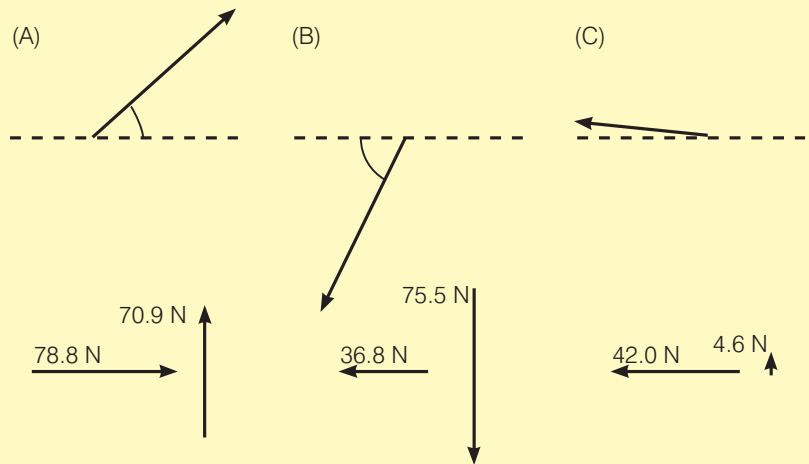
Figure 1.29 Three forces, A, B and C at different angles



Each of these forces could then be resolved into horizontal and vertical components. This would give six component vectors – three vertical and three horizontal.

**Discussion activity**

If you had two forces could you work out the size and direction of a third force required to keep the object in equilibrium?



**Figure 1.30** Six components from the three forces in Figure 1.29

Adding up the vertical vectors:

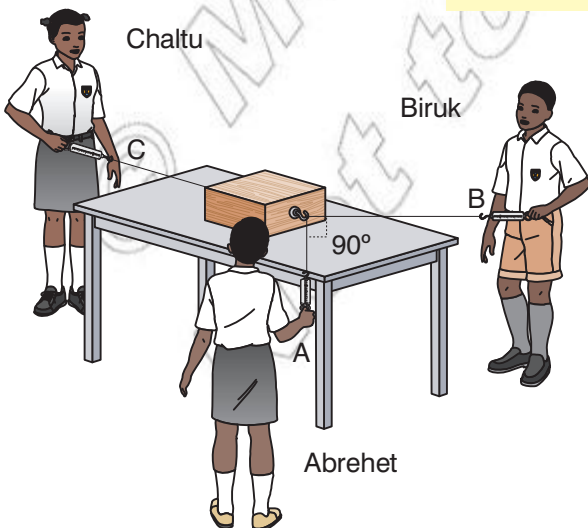
$$70.9 \text{ N} - 75.5 \text{ N} + 4.6 \text{ N} = 0 \text{ N}$$

Adding up the horizontal vectors:

$$78.8 \text{ N} - 36.8 \text{ N} - 42.0 \text{ N} = 0 \text{ N}$$

There is no resultant force so the object must be in equilibrium. Be careful to ensure you add or subtract the vectors depending on their direction.

You could repeat this technique for any number of forces! If the components don't all cancel out then the object will not be in equilibrium.



**Figure 1.31** Investigating vectors

The box pulled by Chaltu, Biruk and Abrehet is in equilibrium. This means that:

The sum of the forces exerted by Abrehet and Biruk is equal to the force exerted by Chaltu

OR

The sum of the forces exerted by Biruk and Chaltu is equal to the force exerted by Abrehet

OR

The sum of the forces exerted by Chaltu and Abrehet is equal to the force exerted by Biruk.

**Activity 1.5: Experimentally determining equilibrium**

There are a number of experiments you could do to investigate forces in equilibrium. Here is one example.

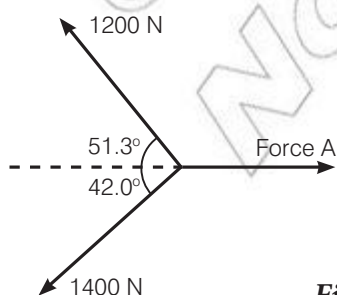
You are going to pull on a block of wood with two forces. You will find the resultant of the two forces, and then check your findings by vector addition.

- Find a suitable block of wood, and three forcemeters (newtonmeters or spring balances). Place the block on a sheet of plain paper.
- Attach two of the forcemeters (A and B) to one end of the block, as shown in Figure 1.31. Attach the third (C) to the opposite end.
- One person pulls on each forcemeter. A and B should be at an angle of  $90^\circ$  to each other. C is in the opposite direction. Pull the forcemeters so that their effects balance.
- On the paper, record the magnitudes and directions of the three forces.
- Now find the resultant of forces A and B (either by scale drawing or by calculation).
- Because force C balances forces A and B, it must be equal and opposite to the resultant of A and B. Did you find this?
- Repeat the experiment with different forces at a different angle.

You could repeat the experiment without one of the forcemeters. You could then, either by scale diagram or mathematically, determine the size and direction of the unknown force.

**Review questions**

1. What is meant by the term equilibrium?
2. Give three examples of objects in equilibrium found in the classroom and draw an approximate scale diagram for the object.
3. Three forces are acting on an object (Figure 1.32) which is in equilibrium. Determine force A.



*Figure 1.32 Three forces, acting on a ship.*

## Summary

In this section you have learnt that:

- An object is said to be in equilibrium when there are no resultant forces acting on it.
- Scale diagrams can be used to determine whether or not an object is in equilibrium.
- If there are three forces acting on an object in equilibrium then when drawn they form a triangle.
- Using the component method you can mathematically determine if an object is in equilibrium.

## End of unit questions

1. Distinguish between a vector and a scalar quantity. Give four examples of each.
2. State which of the following are vectors and which are scalars: distance, mass, time, weight, volume, density, speed, velocity, acceleration, force, temperature and energy.
3. A velocity of magnitude 40 m/s is directed at an angle of  $40^\circ$  East of North. Draw a vector on paper to represent this velocity.
4. A car travels 3 km due North, then 5 km East. Represent these displacements graphically and determine the resultant displacement.
5. Two forces, one of 12 N and another of 24 N, act on a body in such a way that they make an angle of  $90^\circ$  with each other. Find the resultant of the two forces.
6. Two cars A and B are moving along a straight road in the same direction with velocities of 25 km/h and 40 km/h, respectively. Find the velocity of car B relative to car A.
7. Calculate the component of a force of 200 N at a direction of  $60^\circ$  to the force.

Contents	
Section	Learning competencies
2.1 Uniform motion (page 16)	<ul style="list-style-type: none"> <li>Describe the characteristics of uniform motion.</li> <li>Define the terms distance, displacement, speed and velocity.</li> <li>Explain the difference between distance and displacement.</li> <li>Distinguish between average and instantaneous speeds and velocities.</li> </ul>
2.2 Uniformly accelerated motion (page 19)	<ul style="list-style-type: none"> <li>Define the term acceleration.</li> <li>Describe the meaning of the term uniformly accelerated motion.</li> <li>Explain the meaning of the unit <math>\text{m/s}^2</math>.</li> <li>Use velocity–time graphs to determine the acceleration of an object.</li> </ul>
2.3 Graphical description of uniformly accelerated motion (page 22)	<ul style="list-style-type: none"> <li>Describe the key features of distance–time and displacement–time graphs.</li> <li>Use displacement–time graphs to determine the velocity of an object.</li> <li>Describe the key features of velocity–time graphs.</li> <li>Use velocity–time graphs to determine the acceleration of an object and the displacement.</li> </ul>
2.4 Equations of uniformly accelerated motion (page 28)	<ul style="list-style-type: none"> <li>Describe the equations of uniformly accelerated motion.</li> <li>Use these equations to solve problems.</li> <li>Explain the importance of using the correct sign convention (+ or –) when dealing with velocities and accelerations.</li> <li>Define the meaning of the term free fall.</li> <li>Apply the equations to solve problems relating to free fall.</li> </ul>
2.5 Relative velocity in one dimension (page 36)	<ul style="list-style-type: none"> <li>Explain the meaning of the term reference point (or reference frame).</li> <li>Describe the relative velocities of objects.</li> <li>Calculate the relative velocity of a body with respect to another body when moving in the same or in the opposite direction.</li> </ul>

It is almost impossible to imagine yourself living in a world without motion. Stand still, perfectly still; are you in motion? Yes you are... the Earth is spinning at over 450 m/s and even more mind boggling, it is travelling around the Sun with a speed of 30 000 m/s! You are moving very fast.

Every physicist needs a detailed understanding of motion. From catching a ball to driving a car, motion affects our daily lives. How things move is an important aspect of physics.

This unit looks at how things move. You will learn techniques to correctly describe the motion of objects, how to calculate how a certain object will move and the fact that all motion is in fact relative.

**KEY WORDS**

**uniform motion** *the motion of an object moving at a steady speed in a straight line*

**displacement** *distance moved in a particular direction*

**Think about this...**

If an object is travelling in a circle at a steady speed why is this not considered to be uniform motion?

**Activity 2.1: Distance and displacement for a journey**

Using a map, design a journey from one town to another. By carefully considering the route determine the distance and the displacement for the journey.

Repeat, but this time make the journey much larger! Perhaps starting at Addis Ababa and ending up in a different continent.



**Figure 2.2** Displacement when travelling in a circle

**Discussion activity**

What would the distance and displacement be after half a lap?

What about three and a half laps?

**2.1 Uniform motion**

By the end of this section you should be able to:

- Describe the characteristics of uniform motion.
- Define the terms distance, displacement, speed and velocity.
- Explain the difference between distance and displacement.
- Distinguish between average and instantaneous speeds and velocities.

**What is uniform motion?**

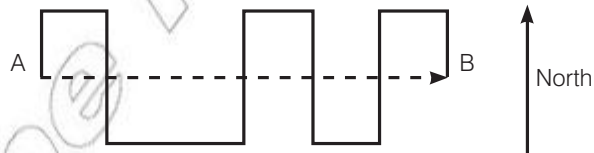
In order to understand motion there are several key terms we need to understand. **Uniform motion** refers to an object moving at a steady speed in a straight line. If it is speeding up, slowing down or changing its direction then its motion is not uniform.

An example could be a bus driving at a steady 100 km/h along a straight road. The bus's motion is said to be uniform.

**Distance and displacement**

We have used the term displacement in the previous unit.

**Displacement** is a vector quantity and so it is very different from distance.



**Figure 2.1** The difference between distance and displacement for a journey

Imagine a person travels from A to B following the black line (Figure 2.1). They would travel a distance of 32 km. This is how far they have actually travelled.

However, their displacement (the dotted line) would only be 12 km East. This is how far they have travelled in a particular direction (in this case East).

A more extreme example could be athletes running around a circular track. If they complete six laps, with each lap being 1.0 km, then they would have travelled a distance of 6.0 km. However, as they are back where they started, their displacement would be zero!

Each lap covers a distance of 1.0 km but the displacement after each lap is zero.

## Speed and velocity

The differences between distance and displacement are even more important when calculating average speed and average velocity.

$$\text{average speed} = \frac{\text{distance travelled}}{\text{time taken}}$$

$$\text{average velocity} = \frac{\text{displacement}}{\text{time taken}}$$

Speed is a scalar quantity whereas velocity is a vector quantity. Therefore, velocity must always include a direction.

Using the journey in Figure 2.1 we can calculate the average speed and the average velocity. Let's assume it took 6 hours to complete the journey.

$$\text{average speed} = \frac{\text{distance travelled}}{\text{time taken}} \quad \textit{State principle or equation to be used (definition of average speed)}$$

$$\text{average speed} = \frac{32 \text{ km}}{6 \text{ h}} \quad \textit{Substitute in known values and complete calculation}$$

$$\text{average speed} = 5.3 \text{ km/h} \quad \textit{Clearly state the answer with unit}$$

No direction needs to be given because speed is a scalar quantity

$$\text{average velocity} = \frac{\text{displacement}}{\text{time taken}} \quad \textit{State principle or equation to be used (definition of average velocity)}$$

$$\text{average velocity} = \frac{12 \text{ km, East}}{6 \text{ h}} \quad \textit{Substitute in known values and complete calculation}$$

$$\text{average velocity} = 2.0 \text{ km/h East} \quad \textit{Clearly state the answer with unit}$$

The differences between average speed and average velocity can be seen clearly in this simple calculation.

## Average speed and velocity

It is very important to stress that these are averages. At different times the person could have been travelling faster or slower than their average speed. Think about a bus ride from one city to another – the journey may be 200 km long and take four hours. This would give an average speed of 50 km/h.

Looking at the journey in more detail we might find on the main road that the bus travels at 100 km/h but in the city it may have to travel much slower, perhaps 30 km/h. Also, being a bus, it has to stop to pick people up! Its speed is then 0 km/h. The bus is very rarely travelling at 50 km/h.

Average speeds and average velocities are useful but they do leave out a great deal of information about the nature of the journey.

## Think about this...

If Deratu takes 15 minutes to complete 12 laps on the running track at Addis Ababa Stadium, what is her average speed if one lap is 450 m long? What would her average velocity be?



**Figure 2.3** What speed and velocity did Deratu achieve?

## Activity 2.2: Average speed and average velocity

In small groups, use a metre stick or travel wheel to measure out a short (15 m) course.

Draw a scale diagram of your course.

Take turns to run, walk, crawl (whatever you like!) through the course making sure to time your journey each time.

Use your measurements to determine your average speed and average velocity in each case.

## KEY WORDS

**instantaneous speed** *speed at a given instant in time*

**instantaneous velocity** *velocity at a given instant in time*

### Instantaneous speed and velocity

As an alternative, the terms **instantaneous speed** and **instantaneous velocity** are used. In the case of instantaneous velocity, this refers to the velocity at any given instant in time (the same is true for speed).

Instantaneous velocity is often changing. This might be due to the object getting faster, getting slower or even changing direction. This is because velocity is a vector quantity, so if the direction changes so does the velocity.

An extreme example of this is an object going around a circle at a steady speed. Here the speed of the object is constant but its velocity is always changing.

If an object is travelling with uniform motion then the instantaneous velocity (and speed) remains the same.

### Summary

In this section you have learnt that:

- Uniform motion is when an object travels at constant speed in a straight line.
- Distance is a scalar quantity, whereas displacement is a vector quantity.
- Average speed = distance travelled / time taken.
- Average velocity = displacement / time taken.
- Instantaneous velocity is the velocity at any given instant in time.

### Review questions

1. Using examples, explain the difference between distance and displacement.
2. The Earth is, on average, 150 million km from the Sun. Calculate its average speed in orbit.
3. A runner jogs 12 km North then turns and runs 16 km East in three hours.
  - a) What is his displacement?
  - b) Calculate his average speed.
  - c) Calculate his average velocity (including the direction).

## 2.2 Uniformly accelerated motion

By the end of this section you should be able to:

- Define the term acceleration.
- Describe the meaning of the term uniformly accelerated motion.
- Explain the meaning of the unit  $\text{m/s}^2$ .
- Use velocity–time graphs to determine the acceleration of an object

### KEY WORD

**acceleration** *the rate of change of velocity*

### What is acceleration?

The term **acceleration** has a very specific definition.

- **Acceleration is the rate of change of velocity.**

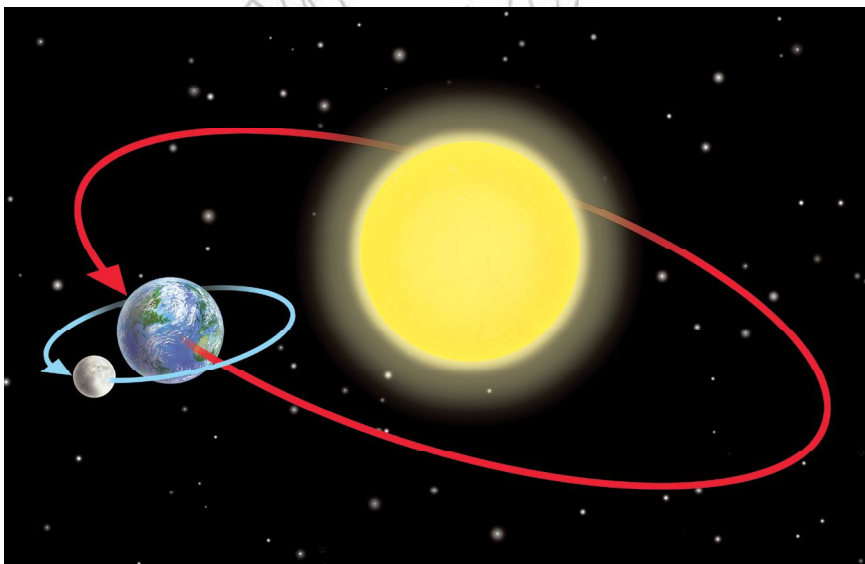
This means that whenever an object's velocity is changing it is accelerating. The faster the velocity changes, the greater the acceleration. Acceleration is the change in velocity per unit time.

It is important to note that it is a change in velocity not a change in speed. A change in velocity might be:

- getting faster
- getting slower
- changing direction.

It is possible to travel at a constant speed but with a changing velocity. For example, any object moving at a steady speed in a circle must be accelerating even though its speed is not changing. This is because when an object moves in a circle:

- its direction changes.
- This means its velocity must be changing
- and if its velocity is changing it is accelerating.



### DID YOU KNOW?

The famous Ethiopian great distance runner, Miruts Yifter, was nicknamed the “gear changer”. He used to accelerate at the finishing lap of 10 000 and 5000 m races.

**Figure 2.4** The Earth follows a near perfect circular orbit. It travels at a fairly steady speed of around 30 000  $\text{m/s}$  but its velocity is always changing.



The acceleration of an object depends on the forces acting on it (more on this in unit 3).

If these forces don't change then the acceleration of the object doesn't change. Uniform acceleration refers to situations where the acceleration of an object remains constant. This might be an acceleration of  $0 \text{ m/s}^2$ , in which case the velocity of the object also remains constant. Most real world situations involve changing forces (most notably drag as objects get faster); this means the acceleration of an object often changes as it gets faster.

### What does $8 \text{ m/s}^2$ mean?

Acceleration has strange units.

Velocity is usually measured in  $\text{m/s}$  and as acceleration is the change in velocity per second, acceleration is measured in  $\text{m/s/s}$  or  $\text{m/s}^2$ .

An acceleration of  $8 \text{ m/s}^2$  means the object will be increasing its velocity by  $8 \text{ m/s}$  every single second. So if it started from rest, then after 1 second it would be travelling at  $8 \text{ m/s}$ , after 2 seconds at  $16 \text{ m/s}$ , after 3 second at  $24 \text{ m/s}$ , etc.

Alternatively, an acceleration of  $-9 \text{ m/s}^2$  means the velocity decreases by  $9 \text{ m/s}$  every single second. Imagine an object initially travelling at  $45 \text{ m/s}$ . It accelerates at  $-9 \text{ m/s}^2$  (or you could say decelerates at  $9 \text{ m/s}^2$ ). After one second it would be travelling at  $36 \text{ m/s}$ , after two seconds at  $27 \text{ m/s}$ , after three seconds at  $18 \text{ m/s}$ , etc.



Figure 2.5 A car increases its velocity as it accelerates.

### Acceleration calculations

To calculate acceleration we use:

$$\text{average acceleration} = \frac{\text{change in velocity}}{\text{time taken}}$$

For example, a car going from  $10 \text{ m/s}$  to  $30 \text{ m/s}$  in 4 seconds:

$$\text{average acceleration} = \frac{\text{change in velocity}}{\text{time taken}} \quad \text{State principle or equation to be used (definition of average acceleration)}$$

$$\text{average acceleration} = \frac{(30 \text{ m/s} - 10 \text{ m/s})}{4 \text{ s}} \quad \text{Substitute in known values}$$

$$\text{average acceleration} = \frac{20 \text{ m/s}}{4 \text{ s}} \quad \text{Complete calculation in brackets}$$

$$\text{average acceleration} = 5 \text{ m/s}^2 \quad \text{Clearly state the answer with unit}$$

It is a positive number as the car's velocity is increasing from  $10 \text{ m/s}$  to  $30 \text{ m/s}$ . Its velocity increases by  $5 \text{ m/s}$  every second.

What about the same car braking to a stop? If it goes from  $30 \text{ m/s}$  to  $0 \text{ m/s}$  (stop) in 10 seconds, what is its acceleration?

$$\text{average acceleration} = \frac{\text{change in velocity}}{\text{time taken}} \quad \text{State principle or equation to be used (definition of average acceleration)}$$

$$\text{average acceleration} = \frac{(0 \text{ m/s} - 30 \text{ m/s})}{10 \text{ s}} \quad \textit{Substitute in known values}$$

$$\text{average acceleration} = \frac{-30 \text{ m/s}}{10 \text{ s}} \quad \textit{Complete calculation in brackets}$$

$$\text{average acceleration} = -3 \text{ m/s}^2 \quad \textit{Clearly state the answer with unit}$$

It is a negative number because the car's velocity is decreasing from 30 m/s to 0 m/s. Its velocity decreases by 3 m/s every second until it comes to rest.

A more complex problem might involve calculating the original velocity of an object.

For example, an aircraft accelerates at  $10 \text{ m/s}^2$  for 15 s. Its final velocity is 320 m/s. Find its initial velocity before it accelerated.

$$\text{average acceleration} = \frac{\text{change in velocity}}{\text{time taken}}$$

This can be rearranged to:

$$\text{average acceleration} \times \text{time taken} = \text{change in velocity}$$

$$10 \text{ m/s}^2 \times 15 \text{ s} = \text{change in velocity}$$

$$150 \text{ m/s} = \text{change in velocity}$$

The final velocity is 320 m/s and the change in velocity is 150 m/s. To find the initial velocity we use:

$$\text{initial velocity} = \text{final velocity} - \text{change in velocity}$$

$$\text{initial velocity} = 320 \text{ m/s} - 150 \text{ m/s}$$

$$\text{initial velocity} = 170 \text{ m/s}$$

## Summary

In this section you have learnt that:

- Acceleration is defined as the rate of change of velocity.
- Acceleration is measured in  $\text{m/s}^2$ .
- When an object is uniformly accelerated, its acceleration remains constant.

## Review questions

1. Define acceleration and state its units.
2. A car accelerates from 10 m/s to 28 m/s in 6 s. Find the average acceleration.
3. An aircraft decelerates at  $0.5 \text{ m/s}^2$ . After 8 minutes its velocity has dropped to 160 m/s. Find its initial velocity.

## 2.3 Graphical description of uniformly accelerated motion

By the end of this section you should be able to:

- Describe the key features of distance–time and displacement–time graphs.
- Use displacement–time graphs to determine the velocity of an object.
- Describe the key features of velocity–time graphs.
- Use velocity–time graphs to determine the acceleration of an object and the displacement.

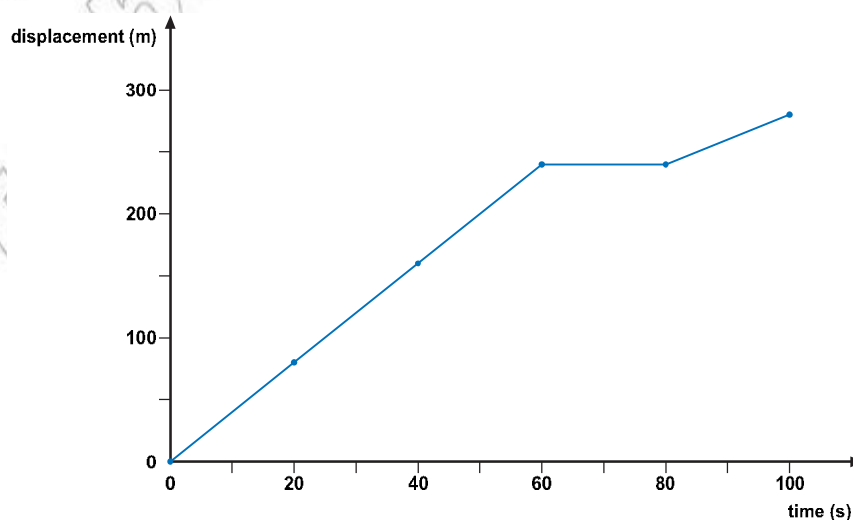
### Motion graphs

Average velocities can only tell us a certain amount of information. If we need more detail then motion graphs are used. In order to determine instantaneous velocities we can plot displacement–time graphs.

A graph is a useful way of showing how something has moved. To draw a graph, we need information about an object's displacement at different times. Table 2.1 shows the displacement of a cyclist on the way to school.

**Table 2.1** Displacement of a cyclist

Displacement (m)	0	80	160	240	240	280
Time (s)	0	20	40	60	80	100



**Figure 2.6** Displacement–time graph for a cyclist

The information in the table has been used to draw the graph (Figure 2.6). Note the axes of the graph have been carefully labelled to show the quantity and unit:

- time in seconds on the  $x$ -axis
- displacement in metres on the  $y$ -axis.

We can tell quite a lot from this graph.

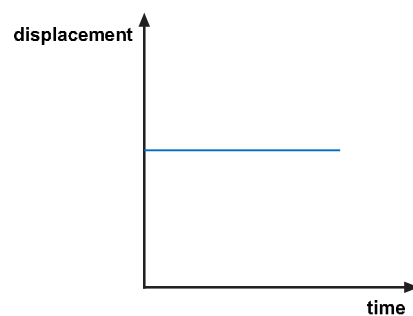
- At first, the graph is a straight line sloping upwards. The cyclist went at a steady speed for the first 60 s.
- Then the graph is horizontal. The cyclist stopped for 20 s.
- Then the graph slopes upwards again, but less steeply. During the last 20 s, the cyclist moved more slowly than before.

Figure 2.7 summarises how to interpret the shape of a displacement–time graph. You can see that the steeper the gradient (slope) of the graph, the greater the velocity of the moving object. A curved graph indicates that the object’s velocity is changing.

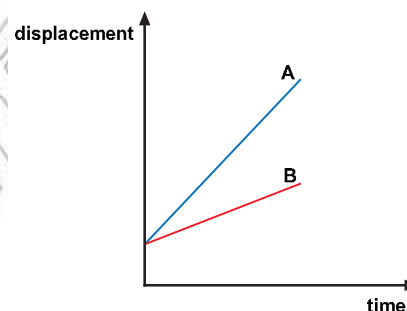
### Calculating velocity

From the displacement–time graph, we can work out an object’s velocity (as explained in the worked example):

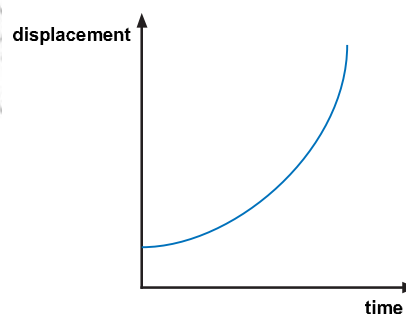
- Velocity = gradient of displacement–time graph.



Horizontal line  
Constant displacement  
Velocity = 0



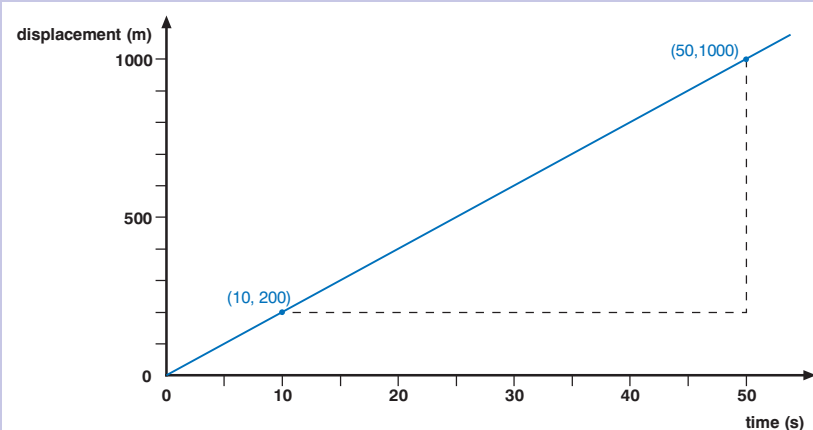
Straight line, sloping upwards  
Constant velocity  
A has a greater velocity than B



Graph curving  
Velocity is changing

**Figure 2.7** Different displacement–time graphs

### Worked example



**Figure 2.8** Displacement–time graph of a taxi

Figure 2.8 is a displacement–time graph for a moving taxi. Find its velocity.

Choose two points on the graph (they should not be too close together).

Draw horizontal and vertical lines to complete a right-angled triangle.

Calculate the displacement and time represented by these two sides of the triangle:

$$\text{displacement} = 1000 \text{ m} - 200 \text{ m} = 800 \text{ m}$$

$$\text{time} = 50 \text{ s} - 10 \text{ s} = 40 \text{ s}$$

### Activity 2.3: Distance–time graph on way to school

Carefully sketch out a distance–time graph for your journey into school. Describe each section of your graph with a partner.

Calculate velocity in the usual way:

$$\text{velocity} = \frac{\text{displacement}}{\text{time}} = \frac{800 \text{ m}}{40 \text{ s}} = 20 \text{ m/s}$$

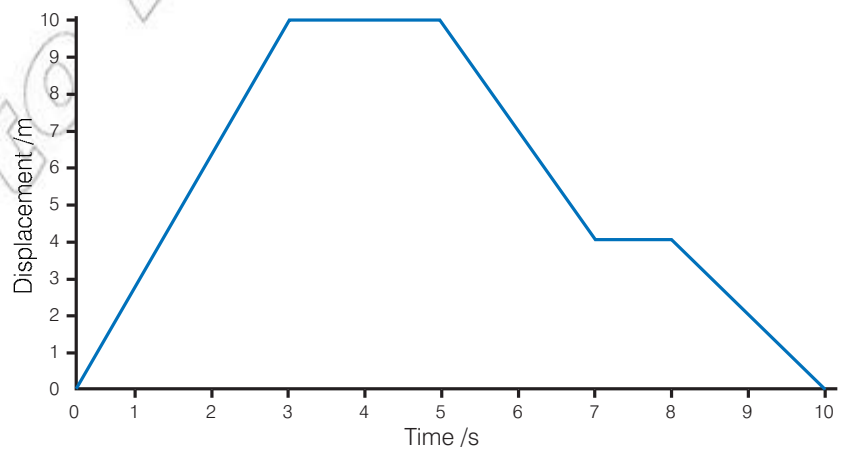
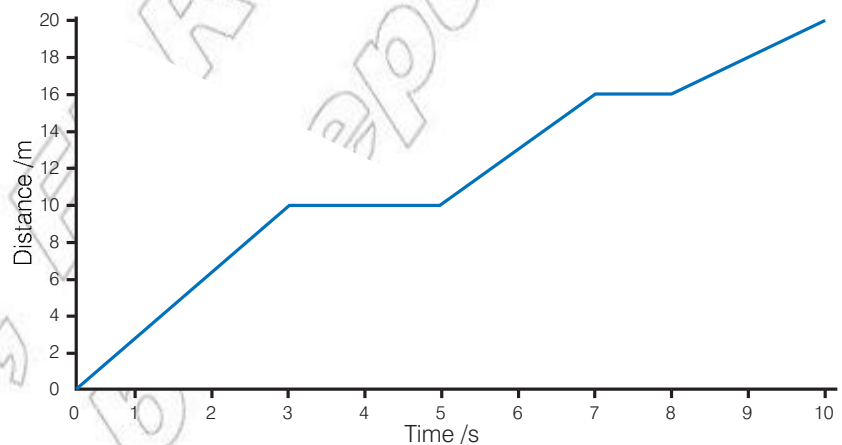
So the taxi is travelling at 20 m/s.

### Distance–time and displacement–time graphs

Although the key features are the same, there is one big difference between distance–time and displacement–time graphs.

As distance is a scalar quantity it only goes up and up. The distance never goes down.

However, as displacement is a vector quantity it can also go down. For example, if you walk 10 m away from your friend heading North and then stop you have travelled a distance of 10 m and your displacement is 10 m North. However, if you then turn around and walk 6 m back towards your friend you will have travelled 16 m but your displacement would then be only 4 m North. This can be seen in the two examples below.



**Figure 2.9** Distance–time and displacement–time graphs for the same journey.

You can clearly see the displacement begin to fall as you head back in the direction you came from. Eventually if you end up back by your friend your displacement will be 0 m but you will have travelled a distance of 20 m.

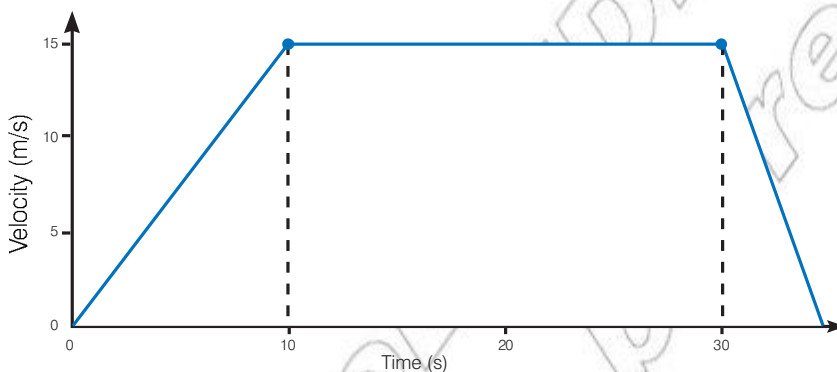
	Gradient	Negative gradients
Distance–time graph	Speed	No
Displacement–time graph	Velocity	Yes

**Table 2.2** A comparison between distance–time and displacement–time graphs

This means you can get negative values from the gradient of a displacement–time graph but not from a distance–time graph. This makes sense if you think about it. You might get a negative velocity of  $-4$  m/s but negative speeds do not make any sense.

## Velocity–time graphs

Just as a displacement–time graph shows how far an object has moved, a velocity–time graph shows how its velocity changes as it travels along. Figure 2.10 shows an example; in this case, the motion of a car at the start of its journey. We can deduce several points from the graph.



**Figure 2.10** A velocity–time graph for a car.

At the start, the car was not moving.

- velocity = 0 when time = 0

The car accelerated at a steady rate during the first 10 s until it reached a velocity of 15 m/s.

- the graph is a straight line, sloping upwards

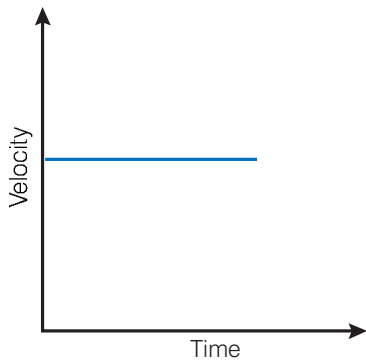
The car travelled at 15 m/s for 20 s.

- the graph is horizontal, so acceleration = 0

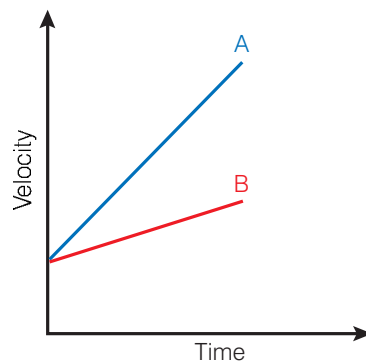
After 30 s, the car decelerated rapidly to a halt.

- graph slopes steeply down to velocity = 0

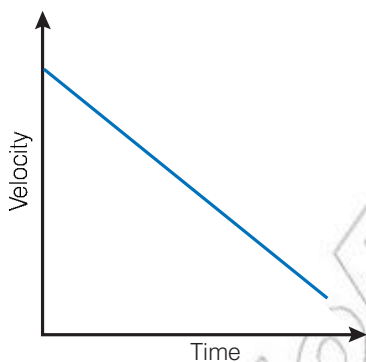
You can learn a lot from the shape of a velocity–time graph, as shown in Figure 2.11. Take care! Do not confuse these with displacement–time graphs. Always check the labels on the axes before interpreting a graph.



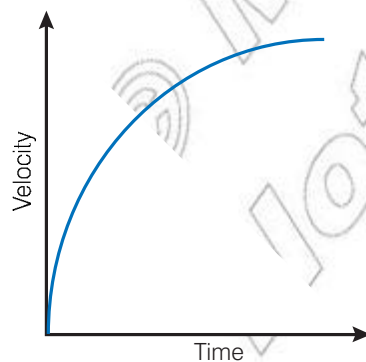
Horizontal line  
Constant velocity  
Acceleration = 0



Straight line, sloping upwards  
Constant acceleration  
A has a greater acceleration than B



Straight line, sloping downwards  
Decelerating  
Acceleration is negative



Graph curving  
Acceleration is changing

**Figure 2.11** Four velocity–time graphs.

If the velocity–time graph is a straight line, the object’s acceleration is constant, and we say that it is moving with **uniform acceleration**.

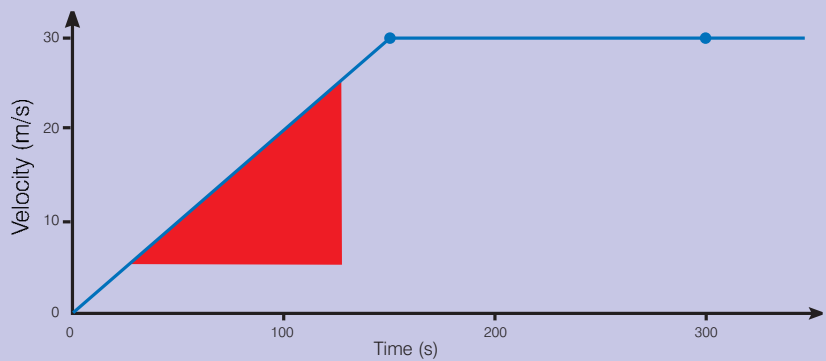
### Calculating acceleration and displacement

We can calculate two quantities from a velocity–time graph. The worked examples show how to do this.

- Acceleration is the gradient of a velocity–time graph.
- Displacement is the area under a velocity–time graph.

#### Worked example

Figure 2.12 shows how the velocity of a train changed as it set off from a station. Calculate its initial acceleration.

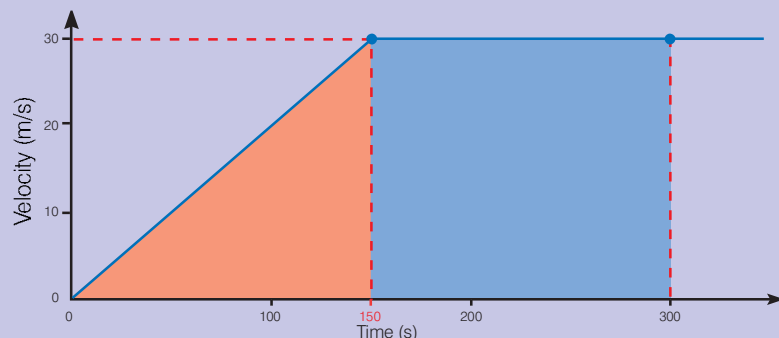


**Figure 2.12** Velocity–time graph for a train

- Choose two points on the graph. As before, select points that are far apart.
- Complete a right-angled triangle.
- Calculate the change in velocity and the time taken:  
change in velocity = 25 m/s – 5 m/s = 20 m/s  
time taken = 125 s – 25 s = 100 s
- Calculate the acceleration:

$$\text{acceleration} = \text{gradient of graph} = \frac{20 \text{ m/s}}{100 \text{ s}} = 0.2 \text{ m/s}^2$$

Calculate the distance travelled by the train during the first 300 s of its journey.



**Figure 2.13** Finding the displacement of the train from its velocity–time graph.

Figure 2.13 shows the same graph as Figure 2.12; this time, though, we have to calculate displacement, which is equal to the area under the graph. The area is divided into two parts: a triangle and a rectangle. (Area of triangle =  $\frac{1}{2} \times \text{base} \times \text{height}$ ; area of rectangle =  $\text{base} \times \text{height}$ .)

displacement = area of triangle + area of rectangle

$$= (\frac{1}{2} \times 30 \text{ m/s} \times 150 \text{ s}) + (30 \text{ m/s} \times 150 \text{ s})$$

$$= 2250 \text{ m} + 4500 \text{ m}$$

$$= 6750 \text{ m}$$

### KEY WORDS

**uniform acceleration** *a*  
constant value of acceleration

### Think about this...

It is important to note that the area under the line may also be negative; this would indicate a negative displacement. In this case the line would dip under the x-axis.

### Activity 2.4: Graphs that tell stories

A velocity–time graph can tell the story of a journey. Here is one driver’s description of a recent trip.

‘We crawled along through the city traffic at 6 m/s for five minutes. Then we left the city, and we gradually accelerated to 24 m/s in 20 s. We kept going at this speed for two minutes, but then I noticed an accident on the road ahead and I braked, so that we came to a halt in 8 s.

- 1 Draw a graph to represent this journey. (Remember, all the times must be in seconds.)
- 2 From your graph, calculate the car’s acceleration and deceleration.
- 3 Calculate the total distance travelled by the car. Now, make up your own story and challenge a partner to draw the graph and make the calculations.

### Summary

In this section you have learnt that:

- Distance–time, displacement–time and velocity–time graphs may be used to represent an object’s motion.
- The gradient of a displacement–time graph is equal to the velocity of the object.
- The gradient of the line of a velocity–time graph is equal to the acceleration.
- The area under the line of a velocity–time graph is equal to the displacement.
- Acceleration is defined as the rate of change of velocity.
- Acceleration is measured in  $\text{m/s}^2$ .



### Review questions

1. Draw a displacement–time graph for the following:

<b>Displacement (m)</b>	0	20	40	40	80	80	60	40	0
<b>Time (s)</b>	0	10	20	30	40	50	60	70	80

- Explain the different sections of the graph in as much detail as you can.
  - Use the graph to determine the maximum velocity.
  - Find the average velocity after 45 s.
  - Find the instantaneous velocity at 45 s.
2. The following data were collected during a short race between two friends.

<b>Velocity (m/s)</b>	0	0.5	1	1.5	2	2	4	6	2	0
<b>Time (s)</b>	0	2	4	6	8	10	12	14	16	18

- Describe the different sections of the graph.
- Determine the acceleration over the first eight seconds.
- Determine the maximum acceleration.
- Using the graph calculate the displacement:
  - over the first eight seconds
  - the total race.
- Find the maximum velocity reached by the runner.

### 2.4 Equations of uniformly accelerated motion

By the end of this section you should be able to:

- Describe the equations of uniformly accelerated motion.
- Use these equations to solve problems.
- Explain the importance of using the correct sign convention (+ or –) when dealing with velocities and accelerations.
- Define the meaning of the term free fall.
- Apply the equations to solve problems relating to free fall.

As discussed in Section 2.2, acceleration has a very specific definition.

- Acceleration is the rate of change of velocity.

This can be written as:

$$\text{average acceleration} = \text{change in velocity} / \text{time taken}$$

If the acceleration is uniform (i.e. does not change) then the average acceleration is the same as the acceleration during any given time.

So we could rewrite that equation as:

$$\text{acceleration} = \text{change in velocity} / \text{time}$$

**But, only if the acceleration is constant.**

To calculate change in velocity we could use the equation below:

$$\text{change in velocity} = \text{final velocity} - \text{initial velocity}$$

Or in symbols:

$$\text{change in velocity} = v - u$$

where

$$v = \text{final velocity}$$

$$u = \text{initial velocity}$$

This means our first equation could be written as:

$$a = (v - u)/t$$

where

$$v = \text{final velocity}$$

$$u = \text{initial velocity}$$

$$a = \text{acceleration}$$

$$t = \text{time}$$

This first equation is usually written as

$$v = u + at \quad (1)$$

For example, if a car is travelling at 8 m/s and accelerates with uniform acceleration at 2 m/s<sup>2</sup> for 6 s its final velocity will be:

$$v = u + at \quad \textit{State principle or equation to be used}$$

$$v = 8 \text{ m/s} + (2 \text{ m/s}^2 \times 6 \text{ s}) \quad \textit{Substitute in known values and complete calculation}$$

$$v = 20 \text{ m/s} \quad \textit{Clearly state the answer with unit}$$

This equation is often referred to as the first equation of the equations of uniformly accelerated motion; there are four more. Remember, this only applies if the acceleration is constant.

The second equation comes from the definition of velocity:

Velocity is the rate of change of displacement

This can be written as:

$$\text{average velocity} = \text{displacement} / \text{time}$$

If the acceleration is uniform then the average velocity can be found by:

$$\text{average velocity} = (\text{final velocity} + \text{initial velocity}) / 2$$

So the equation becomes:

$$(\text{initial velocity} + \text{final velocity}) / 2 = \text{displacement} / \text{time}$$

Or in symbols

$$(u + v)/2 = s/t$$

### DID YOU KNOW?

The Greek symbol delta  $\Delta$  is often used to represent 'change in'. So the formula for acceleration could be written as  $a = \Delta v / t$ .

### Think about this...

To help confusing  $v$  and  $u$ , remember that  $u$  comes before  $v$  in the alphabet and so  $u$  is the initial velocity, the velocity before  $v$ !

where

$s$  = displacement

$v$  = final velocity

$u$  = initial velocity

$t$  = time

Rather confusingly,  $s$  is often used for displacement. Be careful not to confuse this for speed!

This second equation is usually written as:

$$s = \frac{1}{2}(u + v)t \quad (2)$$

This gives us two of the five equations:

$$v = u + at \quad (1)$$

$$s = \frac{1}{2}(u + v)t \quad (2)$$

Notice that these equations only use five quantities:  $s$ ,  $u$ ,  $v$ ,  $a$  and  $t$ .

The first one is missing  $s$ , the second one is missing  $a$ . The three remaining equations are each missing one of the remaining quantities. They are derived from the two above.

The complete set of equations in their usual form can be seen below:

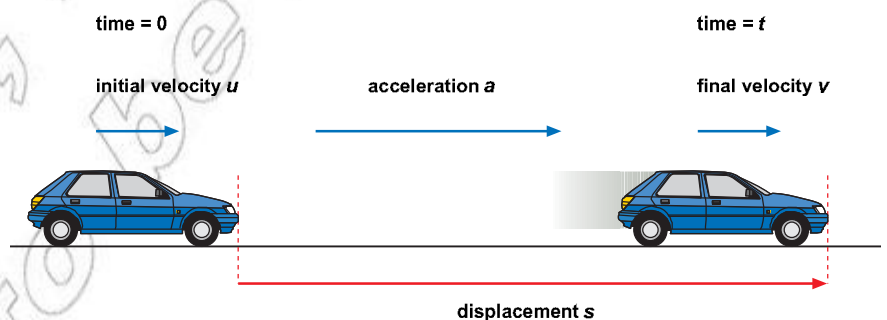
$$v = u + at \quad (1) \quad (\text{no } s)$$

$$s = \frac{1}{2}(u + v)t \quad (2) \quad (\text{no } a)$$

$$s = ut + \frac{1}{2}at^2 \quad (3) \quad (\text{no } v)$$

$$v^2 = u^2 + 2as \quad (4) \quad (\text{no } t)$$

$$s = vt - \frac{1}{2}at^2 \quad (5) \quad (\text{no } u)$$



**Figure 2.14** The five quantities that appear in the equations of motion.

### Activity 2.5: Deriving equations

Using algebra, derive the three remaining equations from the two equations given opposite.

Symbols used in the equations

$s$  = displacement

$v$  = final velocity

$u$  = initial velocity

$a$  = acceleration

$t$  = time

### DID YOU KNOW?

These equations are often referred to as the SUVAT equations. But don't forget, they only apply if the acceleration of the object is uniform (constant).

### Using the equations

These equations can be used to solve a range of problems regarding the motion of accelerating objects. There are lots of terms to use and so to avoid confusion it is often a good idea to draw a quick table like the one below:

**Table 2.3** A table of motion quantities

$s$ (m)	$u$ (m/s)	$v$ (m/s)	$a$ (m/s <sup>2</sup> )	$t$ (s)

You can then fill in the quantities you know and this will help you select the correct equation.

For example:

A cheetah accelerates at  $3 \text{ m/s}^2$  for 5 s. If its final velocity is 24 m/s, determine its initial velocity.

We can now fill in what we know.

$s \text{ (m)}$	$u \text{ (m/s)}$	$v \text{ (m/s)}$	$a \text{ (m/s}^2\text{)}$	$t \text{ (s)}$
	?	24	3	5

From the table you can see we don't have  $s$  so we have to use equation (1), the only one without  $s$  in it.

$$v = u + at \quad \text{State principle or equation to be used}$$

Rearranging to give  $u$  gives

$$u = v - at \quad \text{Rearrange equation to make } u \text{ the subject}$$

$$u = 24 \text{ m/s} - (3 \text{ m/s}^2 \times 5 \text{ s}) \quad \text{Substitute in known values and complete calculation}$$

$$u = 9 \text{ m/s} \quad \text{Clearly state the answer with unit}$$

Here is another example. A runner in a race decides to accelerate right up to the moment he crosses the line. He is initially travelling at 5 m/s and accelerates at  $0.4 \text{ m/s}^2$  for 5 s. Find:

- The distance from the line when he decides to accelerate.
- His final velocity as he crosses the line.

Again we can fill in what we know.

$s \text{ (m)}$	$u \text{ (m/s)}$	$v \text{ (m/s)}$	$a \text{ (m/s}^2\text{)}$	$t \text{ (s)}$
?	5		0.4	5

From the table you can see we don't have  $v$  so we have to use equation (3), the only one without  $v$  in it.

$$s = ut + \frac{1}{2}at^2 \quad \text{State principle or equation to be used}$$

$$s = (5 \text{ m/s} \times 5 \text{ s}) + \frac{1}{2} \times 0.4 \text{ m/s}^2 \times (5 \text{ s})^2 \quad \text{Substitute in known values and complete calculation}$$

$$s = 30 \text{ m} \quad \text{Clearly state the answer with unit}$$

Adding this to the table we get.

$s \text{ (m)}$	$u \text{ (m/s)}$	$v \text{ (m/s)}$	$a \text{ (m/s}^2\text{)}$	$t \text{ (s)}$
30	5	?	0.4	5

To find  $v$  we can use any equation apart from equation (5). Perhaps the best one to use is equation (1) as this does not rely on the value for  $s$ . You may have miscalculated this so it's better to be safe and use values you are certain of if at all possible.

$$v = u + at \quad \text{State principle or equation to be used}$$

$$v = 5 \text{ m/s} + (0.4 \text{ m/s}^2 \times 5 \text{ s}) \quad \text{Substitute in known values and complete calculation}$$

$$v = 7 \text{ m/s} \quad \text{Clearly state the answer with unit}$$

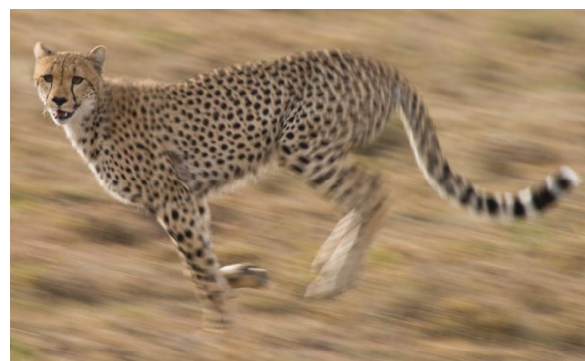
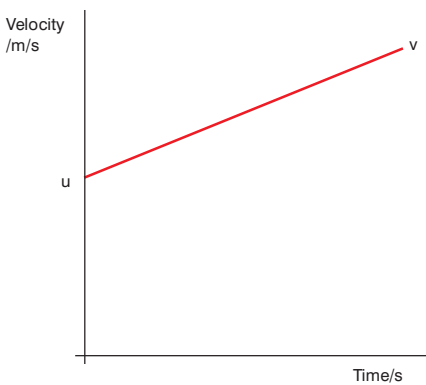


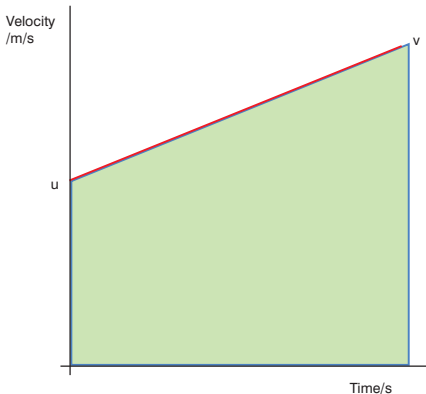
Figure 2.15 Cheetahs are the fastest land animals, reaching speeds of 120 kph!



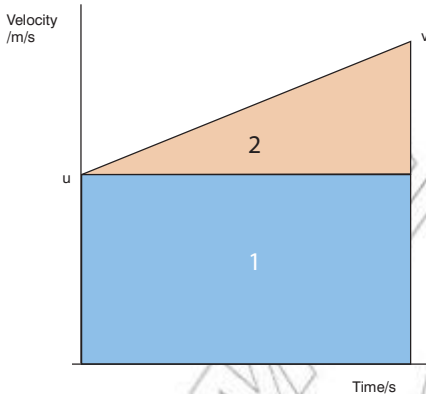
Figure 2.16 How fast does the runner finish?



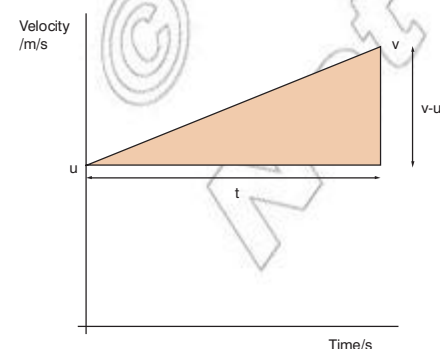
**Figure 2.17** A typical velocity-time graph



**Figure 2.18** The area under the line represents the displacement of the object.



**Figure 2.19** The area can be split into two sections.



**Figure 2.20** The area of the triangle

### Velocity-time graphs for $s = ut + \frac{1}{2}at^2$

Equation (3) can be derived using ideas covered in section 2.3.

A velocity-time graph for an object with constant acceleration might look like the one in Figure 2.17. This might be a marble rolling down an inclined ramp with the velocity measured at two points along the ramp.

The gradient of the line is constant because the acceleration of the object is constant.

The total area under the graph represents the displacement of the object between these two velocities (see Figure 2.18).

This area has two sections, shown as 1 and 2 in Figure 2.19.

The area of the first section is simply  $u \times t$  or  $ut$ . This added to the second area will give the displacement.

The area of the triangle (Figure 2.20) is given by:

$$\frac{1}{2}(v - u) \times t$$

From equation (1),  $v = u + at$ , it follows that  $v - u = at$  and so the area can be expressed as:

$$\frac{1}{2}at \times t \text{ or } \frac{1}{2}at^2$$

The total area is given by the two areas added together. This gives:

$$\text{total area} = ut + \frac{1}{2}at^2$$

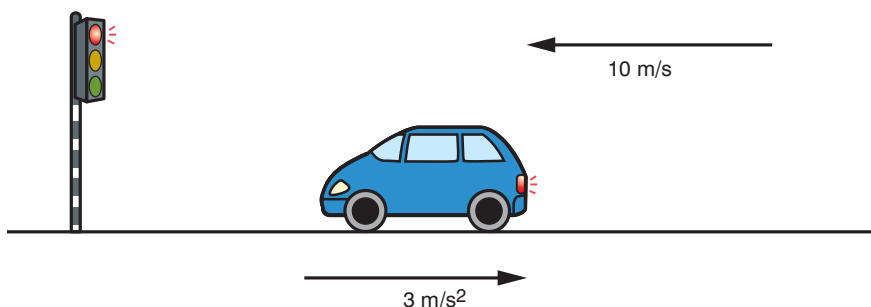
So, the total area is the same as the displacement:

$$s = ut + \frac{1}{2}at^2$$

If the acceleration was zero the graph would be a horizontal line; the area in this case would be just  $ut$ . In other words,  $\frac{1}{2}at^2$  would be 0. Equally, if the object started from rest then  $u$  would be 0 and the graph would be just a triangle, in which case the area would be just  $\frac{1}{2}at^2$  as  $ut$  would be 0.

### Positive or negative?

As both velocity and acceleration are vector quantities their directions are very important. If the velocity is in the same direction as the acceleration then both could be considered to be positive. However, if they are in opposite directions then one must be negative.



**Figure 2.21** A car braking at traffic lights

As an example, Figure 2.21 shows a car approaching a set of traffic lights. If the car has to stop, its velocity is in one direction but the acceleration is in the opposite direction (since it is slowing down). This would give us a velocity of 10 m/s and an acceleration of  $-3 \text{ m/s}^2$ .

Imagine a ball rolling up a very long slope with an initial velocity of 6 m/s. The acceleration acts down the slope and has a value of  $2 \text{ m/s}^2$ . If we wanted to find the velocity of the ball after two seconds we could use one of our equations of constant acceleration.

$s \text{ (m)}$	$u \text{ (m/s)}$	$v \text{ (m/s)}$	$a \text{ (m/s}^2\text{)}$	$t \text{ (s)}$
	6	?	2	2

This table is wrong. We have both initial velocity and acceleration as positive. This is not right as they are in opposite directions.

If we were to use  $v = u + at$  using these values we would get a final velocity of 10 m/s. The ball has got faster as it has travelled up the slope!

Instead if we decide to say the velocity up the slope is positive we get

$s \text{ (m)}$	$u \text{ (m/s)}$	$v \text{ (m/s)}$	$a \text{ (m/s}^2\text{)}$	$t \text{ (s)}$
	6	?	$-2$	2

The acceleration is  $-2 \text{ m/s}^2$  as we have decided that the positive direction is up the slope.

$v = u + at$  *State principle or equation to be used*

$v = 6 \text{ m/s} + (-2 \text{ m/s}^2 \times 2 \text{ s})$  *Substitute in known values and complete calculation*

$v = 2 \text{ m/s}$  *Clearly state the answer with unit*

This makes much more sense! The ball has got slower.

What about if we wanted the velocity after 10 s? Filling in the table we would get:

$s \text{ (m)}$	$u \text{ (m/s)}$	$v \text{ (m/s)}$	$a \text{ (m/s}^2\text{)}$	$t \text{ (s)}$
	6	?	$-2$	10

The acceleration is  $-2 \text{ m/s}^2$  as we have decided that the positive direction is up the slope.

$v = u + at$  *State principle or equation to be used*

$v = 6 \text{ m/s} + (-2 \text{ m/s}^2 \times 10 \text{ s})$  *Substitute in known values and complete calculation*

$v = -14 \text{ m/s}$  *Clearly state the answer with unit*

Our answer is  $-14 \text{ m/s}$ . What does this mean? Because we decided to make the direction up the slope positive,  $-14 \text{ m/s}$  must mean the ball has gradually slowed down, stopped and then rolled back down. After 10 s it is travelling down the slope at 14 m/s.

### Think about this...

It does not really matter which one is negative as long as we think carefully about our answers. Using the car example it would be equally valid to say the velocity is  $-10 \text{ m/s}$  and the acceleration is  $3 \text{ m/s}^2$ .

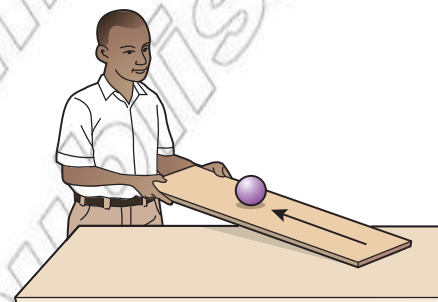


Figure 2.22 Ball rolling up a slope

### Think about this...

We would have got the same answer if we had made the acceleration positive and the initial velocity in the negative direction. Except our final answer would be  $+14 \text{ m/s}$ ; indicating it is in the same direction as the acceleration.

Equally, using  $s = ut + \frac{1}{2}at^2$  we would get a displacement of  $-40 \text{ m}$ , meaning the ball is 40 m lower down the slope than when it started.



**Figure 2.23** Air resistance is very important to parachutists!

### DID YOU KNOW?

Technically, as the definition of free fall does not include any mention of velocity (either magnitude or direction), it also applies to objects initially moving upward. For example, a small marble thrown vertically up into the air is undergoing free fall on both the way up and the way down!



**Figure 2.24** The Leaning Tower of Pisa

## Free fall

Free fall is a kind of motion where the acceleration of the object is just due to the acceleration due to gravity. For this to take place we must assume that air resistance (drag) is not acting on the object. For most examples we are going to look at this as a fair assumption. Air resistance only plays an important role if the object is moving quite fast or has a very large surface area. However, there are plenty of cases when we will need to consider air resistance in the future (for example, a parachutist!).

Around 1590, there was a story about Galileo Galilei (1564–1642), an Italian scientist. It is said he climbed up the Leaning Tower of Pisa to test out his theory of free fall. He dropped two cannon balls, one large one, one small one. Everyone watching thought the larger one, that is the one with more mass, would hit the ground first. Instead they both hit the ground at the same time. Galileo had realised that all objects dropped on Earth accelerate at the same rate; it is only air resistance that slows them down.

When an object is undergoing free fall it will accelerate at  $9.81 \text{ m/s}^2$ ; this is the acceleration due to gravity on the surface of the Earth. It is important to note that if we ignore air resistance then all objects, regardless of their mass, will accelerate at this rate.

This is a little counter-intuitive; our experiences work against us when thinking about free fall. If you imagine a stone and a piece of paper being dropped, it is obvious the stone will hit the ground first! However, this is due to air resistance having a greater effect on the piece of paper. Both the stone and paper initially accelerate at the same rate.

On the Moon there is no atmosphere and so no air resistance. In 1971, American astronaut David Scott simultaneously dropped a hammer and a feather from the same height to demonstrate free fall. The hammer and the feather both fell exactly at the same rate and so hit the ground at the same time!

If we ignore air resistance then the acceleration of all falling objects can be considered to be uniform. We can then use the equations of uniform acceleration to determine how long objects take to hit the ground and what their final velocity is just before impact.

For example, imagine a ball dropped from a height of 4.0 m. How long would it take to hit the ground?

$s$ (m)	$u$ (m/s)	$v$ (m/s)	$a$ (m/s <sup>2</sup> )	$t$ (s)
4.0	0.0 (as dropped)		9.81	?

You can see we've used the initial velocity as 0 m/s, as the ball is dropped, and the acceleration as  $9.81 \text{ m/s}^2$ .

### Worked example

We don't know the final velocity of the ball so we must use equation (3) (there is no  $v$  in this equation).

$$s = ut + \frac{1}{2}at^2 \quad \text{State principle or equation to be used}$$

$ut = 0$ , as the ball was dropped, so the equation becomes:

$$s = \frac{1}{2}at^2$$

This can be rearranged to  $t = \sqrt{2s/a}$  *Rearrange equation to make  $t$  the subject*

$$t = \sqrt{(2 \times 4.0 \text{ m})/9.81 \text{ m/s}^2} \quad \text{Substitute in known values and complete calculation}$$

$$t = 0.9 \text{ s} \quad \text{Clearly state the answer with unit}$$

You can see from this that it does not matter what the mass of the ball is. Any object dropped from 4 m will hit the ground after 0.9 s if we ignore air resistance.

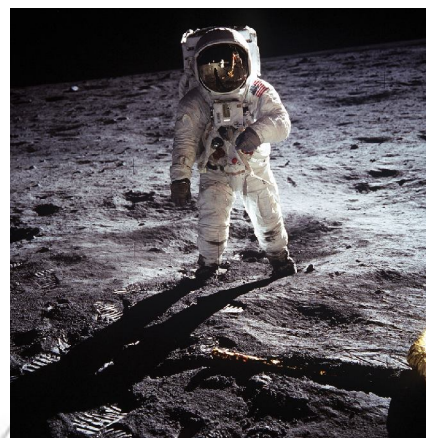


Figure 2.25 Astronaut on the Moon

### Activity 2.6: Dropping a ball

Drop a ball from several different heights and time how long it takes to hit the ground. Record your data carefully and take repeats for each height.

Using equation (3), calculate the time it actually takes to hit the ground. Compare the actual times with your readings and comment on your findings.

### DID YOU KNOW?

The acceleration due to **gravity** varies all over the globe. At sea level it ranges between  $9.79 \text{ m/s}^2$  and  $9.83 \text{ m/s}^2$  depending on location. It also changes with altitude (although not by very much). So we often use a standard value of exactly  $9.80665 \text{ m/s}^2$ .

### KEY WORDS

**gravity** *the force of attraction between an object in the Earth's gravitational field and the Earth itself*

Using our equations of uniform acceleration we can also work out the final vertical velocity. Looking back at the table we now have:

$s$ (m)	$u$ (m/s)	$v$ (m/s)	$a$ (m/s <sup>2</sup> )	$t$ (s)
4.0	0.0 (as dropped)	?	9.81	0.9

### Worked example

We could use either equation (1), (2), (4) or (5) to determine  $v$ . However, equation (4) does not rely on your calculation of time, so this is preferable.

$$v^2 = u^2 + 2as \quad \text{State principle or equation to be used}$$

$$v = \sqrt{u^2 + 2as} \quad \text{Rearrange equation to make } v \text{ the subject}$$

$$v = \sqrt{(0^2 + 2 \times 9.81 \text{ m/s}^2 \times 4.0 \text{ m})} \quad \text{Substitute in known values and complete calculation}$$

$$v = 8.9 \text{ m/s} \quad \text{Clearly state the answer with unit}$$

The equations can also be used if the ball is thrown vertically upwards. In this case it is the same process, but  $u$  is not 0 m/s and it is very important to remember that  $u$  is in one direction and  $a$  is in the other. One will have to be negative!

For example, we can use the equations to work out how long it takes a ball thrown vertically with a velocity of 20 m/s to reach its maximum height and how high it reaches.

Looking at the table we have:

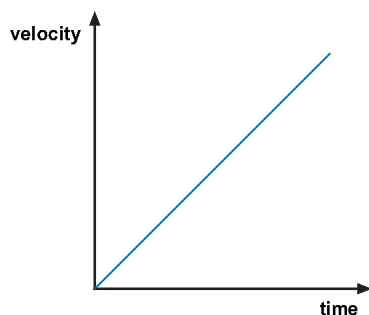
$s$ (m)	$u$ (m/s)	$v$ (m/s)	$a$ (m/s <sup>2</sup> )	$t$ (s)
	20	0	9.81	?

At its maximum height, the velocity of the ball will be 0 m/s. To find  $t$  we use equation (1).

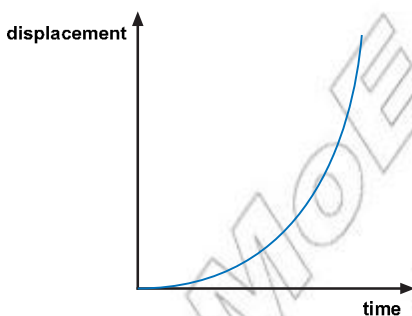


### Think about this...

If you drop an object, the displacement before it hits the ground is given by  $s = \frac{1}{2}at^2$ . If you take  $a$  as  $10 \text{ m/s}^2$  (close enough), this becomes  $s = 5t^2$ . If it takes 1 s to hit the ground then it must have fallen 5 m, 2 s means 20 m, etc. This is handy to work out to approximate height of bridges or depth of wells. Just make sure nobody is standing underneath!



a



b

Figure 2.26 Motion graphs for objects undergoing free fall

$$v = u + at \quad \text{State principle or equation to be used}$$

$$t = (v - u)/a \quad \text{Rearrange equation to make } t \text{ the subject}$$

$$t = (0 \text{ m/s} - 20 \text{ m/s}) / -9.81 \text{ m/s}^2 \quad \text{Substitute in known values and complete calculation}$$

$$t = 2.0 \text{ s} \quad \text{Clearly state the answer with unit}$$

A similar process gives  $s = 14 \text{ m}$ . Try it for yourself!

An object in free fall produces very distinctive displacement–time and velocity–time graphs. The displacement–time and velocity–time graphs for an object in free fall can be seen in Figure 2.26.

### Summary

- There are five equations that describe uniformly accelerated motion; these can be used to solve a range of problems.
- The directions of the velocity and the acceleration of an object are important when deciding whether they are positive or negative values.
- When an object accelerates under gravity it is said to be in free fall.
- The equations of uniform acceleration can be used to solve problems relating to free fall.

### Review questions

1. What are the five equations that describe uniform accelerated motion?
2. A bus accelerates from  $10 \text{ m/s}$  to  $18 \text{ m/s}$  over 3 s. Find:
  - a) The distance the bus covers whilst it is accelerating.
  - b) The acceleration of the bus.
3. A runner slows down after completing a race. Her deceleration is  $0.25 \text{ m/s}^2$ . After 5 s she is travelling at  $4 \text{ m/s}$ , determine her initial velocity.
4. A stone is dropped off a tall building. It takes 5.3 s to hit the ground. Determine the height of the building.
5. Explain what is meant by free fall.

### 2.5 Relative velocity in one dimension

By the end of this section you should be able to:

- Explain the meaning of the term reference frame (or reference point).
- Describe the relative velocities of objects.
- Calculate the relative velocity of a body with respect to another body when moving in the same or in the opposite direction.

## It's all relative!

Whenever we take measurements of displacement the answer we give is always relative. One house might be 1.5 km away from another or one object might be a certain distance from another.

The term **reference frame** (sometimes called reference point or frame of reference) refers to measurements taken from a certain point of view. Most of the measurements you will take are from your own reference frame.

You might think this only applies to displacements, but it also applies to velocities. If you are standing still and a car is approaching you at 12 m/s you might think it has a velocity of 12 m/s in all frames of reference, but you would be wrong. Now imagine you are in a different frame of reference, moving in the same direction as the car at 2 m/s. The car would appear to be moving towards you at 10 m/s. No longer 12 m/s!

The most common frame of reference is the Earth. When you stand still you might think your velocity is zero. This is true in the Earth's frame of reference. However, if you could step off the Earth into space you would see the Earth rotating and moving around the Sun. So you would definitely be moving!

There are several different frames of reference. However, the laws of motion governing a moving object (more on these in unit 3) are only valid if the reference frame is either stationary relative to the moving object or moving at constant velocity. This is often referred to as an inertial frame of reference.

## Relative velocity

As velocity is always measured from a reference frame this means velocity is also always relative. Whenever you record the velocity of an object the value of its velocity is relative to one frame of reference or another. Velocity is usually measured from the Earth's frame of reference; an object is said to have zero velocity if it is not moving relative to the Earth. Equally 30 m/s usually means 30 m/s relative to the Earth.

However, we also often measure velocities from the frame of reference of an observer who is moving at a steady speed.

For example, imagine you are sat on a moving bus and another bus is overtaking you. From your frame of reference the overtaking bus will appear to be moving quite slowly past the window. However, if you were standing on the pavement, the overtaking bus will be moving much faster relative to you.

The relative velocity between two objects can be thought of the difference between their velocities (not their speeds, as the direction is very important).

To calculate the relative velocities between moving objects we can use the following equation:

$$v_{\text{Rab}} = v_a - v_b$$

## DID YOU KNOW?

One of the key ideas in Einstein's theory of special relativity is that the speed of light must be constant in all reference frames. This leads to some very strange effects, including time slowing down for objects moving very, very fast!

## KEY WORDS

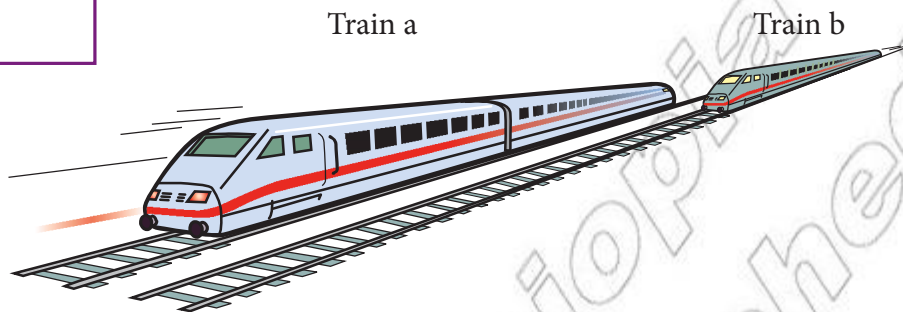
**reference frame** *a point from which measurements are taken*

**KEY WORDS**

**relative velocity** *the difference between the velocities of two moving objects*

For example, the **relative velocity** of two trains on parallel tracks. One train (a) is heading North at 30 m/s the other train (b) is heading South at 20 m/s. In terms of vectors we could say:

$$v_a = 30 \text{ m/s North and } v_b = 20 \text{ m/s South.}$$



$$v_a = 30 \text{ m/s}$$

$$v_b = -20 \text{ m/s}$$

**Figure 2.27** Two trains heading towards each other

As the trains are heading toward each other the driver of train a would see train b approaching at 50 m/s.

$$v_{\text{Rab}} = v_a - v_b$$

$$v_{\text{Rab}} = 30 \text{ m/s} - (-20 \text{ m/s})$$

$$v_{\text{Rab}} = 50 \text{ m/s}$$

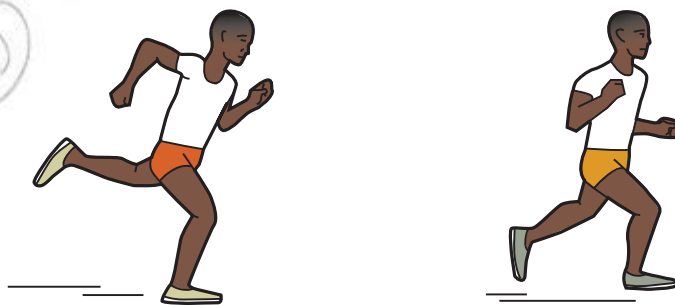
Also, the driver of train b would see train a approaching at 50 m/s! The relative velocity between the two trains is 50 m/s. So if they were 100 m apart it would take two seconds for the trains to pass each other.

We can use the same process to calculate the relative velocity between two athletes running along a long straight road. But this time they are both travelling in the same direction.

The leading runner is travelling a 5 m/s but the athlete in second place is sprinting to catch up. He is travelling at 7 m/s.

Athlete 2

Athlete 1



$$v_2 = 7 \text{ m/s}$$

$$v_1 = 5 \text{ m/s}$$

**Figure 2.29** Two athletes at the closing stages of a race



**Figure 2.28** A travelling train

**Think about this...**

If two trains 18 km apart are travelling towards each other, one with a velocity of 35 m/s and the other moving at 25 m/s, how long would it be before the trains pass by each other?

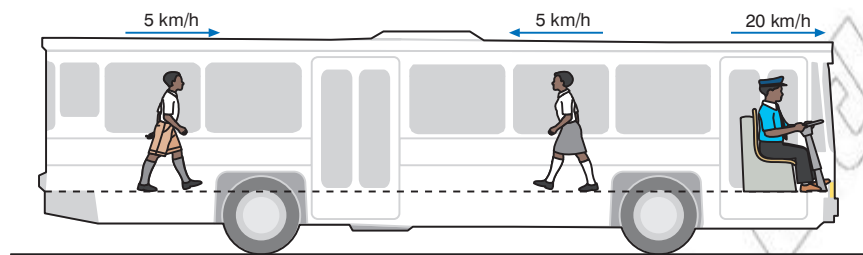
$$v_{R12} = v_1 - v_2 \quad \text{State principle or equation to be used (relative velocity between 1 and 2)}$$

$$v_{R12} = 5 \text{ m/s} - 7 \text{ m/s} \quad \text{Substitute in known values and complete calculation}$$

$$v_{R12} = -2 \text{ m/s} \quad \text{Clearly state the answer with unit}$$

Because we have calculated the velocity of the lead runner relative to the second place runner we get  $-2 \text{ m/s}$ . This means the leading runner would see the second place runner approaching him at  $2 \text{ m/s}$ .

If they are  $20 \text{ m}$  apart it would take the second place runner  $10 \text{ s}$  to catch the leader (assuming they stay at the same speed).



**Figure 2.30** Relative velocities of passengers on a bus

## Review questions

1. Explain what is meant by the term reference frame.
2. Find the relative velocities of the following:
  - a) two cars travelling North on the same road, one travelling at  $15 \text{ m/s}$  the other travelling at  $20 \text{ m/s}$
  - b) two ships sailing down a river, one heading due East at  $4 \text{ m/s}$  the other sailing West at  $2 \text{ m/s}$ .

## Summary

In this section you have learnt that:

- A frame of reference refers to a certain point of view depending on the position and motion of the observer.
- The laws of motion only apply if the reference frame of the observer is stationary or moving at a constant velocity.
- The velocity of an object depends on the frame of reference of the observer.
- The relative velocity between one moving object and another is given by the difference between their velocities.

## Think about this...

This equation can be used if one object is stationary. Here the relative velocity is just the velocity of the moving object! If you are standing on a platform and a train approaches at  $6 \text{ m/s}$ , its relative velocity is  $6 \text{ m/s}$ ! But also the train driver would see you approaching at  $6 \text{ m/s}$ .

## Activity 2.7: People on the bus

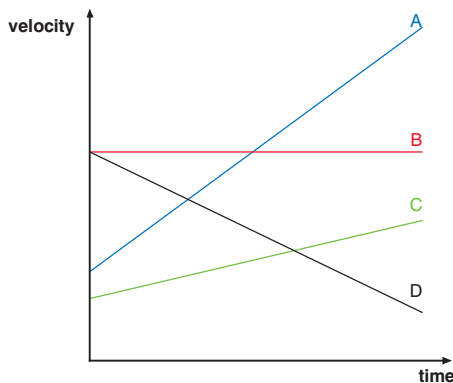
Look at the three people on the bus in Figure 2.30. What are the relative velocities between each of them? What about the relative velocity between the three on the bus and a passenger waiting at the next bus stop?

**End of unit questions**

- How long will a bus take to travel 150 km at an average speed of 40 km/h?
- A cheetah can run at 30 m/s, but only for about 12 s. How far will it run in that time?
- It takes a cheetah just 3 s to reach its top speed of 30 m/s. What is its acceleration?
- Table 2.4 shows how the displacement of a runner changed during a sprint race. Draw a displacement–time graph to show this data, and use it to deduce the runner’s speed in the middle of the race.

**Table 2.4** Data for a sprinter during a race

<b>Displacement (m)</b>	0	4	10	20	50	80	105
<b>Time (s)</b>	0	1	2	3	6	9	12



**Figure 2.31** Velocity–time graphs for four cars.

- Figure 2.31 shows how the velocity of four cars changed as they travelled along a straight road. Give reasons for your answers to these questions:
  - Which car was travelling at a steady speed?
  - Which car was decelerating?
  - Which car had the greatest acceleration?
- Table 2.5 shows how the velocity of a car changed during part of a journey along a main road.
  - Draw a velocity–time graph for the journey.
  - Write a brief description of the journey.
  - The car’s speed changed during two parts of the journey. Calculate its acceleration at these times.

**Table 2.5** Data for part of a car journey – see Question 6

<b>Velocity (m/s)</b>	16	20	24	24	24	21	18
<b>Time (s)</b>	0	10	20	40	60	70	80

- A taxi is travelling at 15 m/s. Its driver accelerates with acceleration 3 m/s<sup>2</sup> for 4 s. What is its new velocity?
- A car accelerates from 20 m/s to 30 m/s in 10 s.
  - Calculate the car’s acceleration using  $v = u + at$ .
  - Draw a velocity–time graph to show the car’s motion. Find the distance it travels by calculating the area under the graph.
  - Check your answer by using the equation  $s = ut + \frac{1}{2}at^2$ .

9. A truck gradually starts off from rest with a uniform acceleration of  $2 \text{ m/s}^2$ . It reaches a velocity of  $16 \text{ m/s}$ . Using the equation  $v^2 = u^2 + 2as$ , calculate the distance it travels while it is accelerating.
10. Table 2.6 shows values of the displacement and velocity of a falling object. Copy and complete the table, and use it to draw displacement–time and velocity–time graphs for the object. (Take  $g = 10 \text{ m/s}^2$ .)

**Table 2.6** The motion of a falling object – see Question 10

<b>Time <math>t</math> (s)</b>	0	1	2	3	4
<b>Displacement <math>s</math> (m)</b>	0	5	20		
<b>Velocity <math>v</math> (m/s)</b>	0	10	20		

11. A stone is dropped from the top of a  $45 \text{ m}$  high building. How fast will it be moving when it reaches the ground? And what will its velocity be?
12. Two cars A and B are moving along a straight road in the same direction with velocities of  $25 \text{ km/h}$  and  $40 \text{ km/h}$ , respectively. Find the velocity of car B relative to car A.
13. An aircraft heads North at  $320 \text{ km/h}$  relative to the wind. The wind velocity is  $80 \text{ km/h}$  from the North. Find the velocity of the aircraft relative to the ground.
14. Two aircraft P and Q are flying at the same speed,  $300 \text{ m/s}$ . The direction along which P is flying is at right angles to the direction along which Q is flying. Find the magnitude of the velocity of the aircraft P relative to aircraft Q.
15. A train travelling along a straight track starts from rest at point A and accelerates uniformly to  $20 \text{ m s}^{-1}$  in  $20 \text{ s}$ . It travels at this speed for  $60 \text{ s}$ , then slows down uniformly to rest in  $40 \text{ s}$  at point C. It stays at rest at C for  $30 \text{ s}$ , then reverses direction, accelerating uniformly to  $10 \text{ m s}^{-1}$  in  $10 \text{ s}$ . It travels at this speed for  $30 \text{ s}$ , then slows down uniformly to rest in  $10 \text{ s}$  when it reaches point B.
- Plot a graph of the motion of the train.
  - Use your graph to calculate:
    - the train's displacement from point A when it reaches point C
    - the train's displacement from point A when it reaches point B
    - the train's acceleration each time its speed changes.

# Forces and Newton's laws of motion

## Unit 3

### Contents

Section	Learning competencies
3.1 Forces in nature (page 43)	<ul style="list-style-type: none"><li>List some of the forces that occur in nature and categorise them as contact or non-contact.</li><li>State Newton's first law.</li><li>Explain the relationship between mass and inertia.</li><li>State Hooke's law and distinguish between elastic and inelastic materials.</li><li>Experimentally determine and describe the force constant of a spring.</li></ul>
3.2 Newton's second law (page 52)	<ul style="list-style-type: none"><li>Distinguish between resultant force and equilibrant force.</li><li>Describe the effect of a force acting on a body.</li><li>Apply Newton's second law (as <math>F_{net} = ma</math>) to solve problems.</li><li>Resolve forces into rectangular components and compose forces acting on a body using component methods.</li><li>Describe the terms weight and weightlessness (including distinguishing between weight and apparent weight).</li><li>Calculate the weight and apparent weight of an object in a range of situations.</li></ul>
3.3 Frictional forces (page 64)	<ul style="list-style-type: none"><li>Explain the causes of frictional forces.</li><li>Describe the differences between limiting friction, static friction and kinetic friction.</li><li>Draw free body diagrams for objects on inclined planes (to include frictional forces) and use these diagrams to solve problems.</li></ul>
3.4 Newton's third law (page 71)	<ul style="list-style-type: none"><li>State Newton's third law.</li><li>Describe experiments to demonstrate it and give examples of where it is applicable.</li></ul>
3.5 Conservation of linear momentum (page 74)	<ul style="list-style-type: none"><li>Define linear momentum and state its units.</li><li>State the law of conservation of momentum.</li><li>Define the term impulse and state its units.</li><li>Solve numerical problems relating to momentum, conservation of momentum and impulse.</li><li>State Newton's second law in terms of momentum.</li></ul>
3.6 Collisions (page 83)	<ul style="list-style-type: none"><li>Distinguish between elastic and inelastic collisions.</li></ul>
3.7 The first condition of equilibrium (page 84)	<ul style="list-style-type: none"><li>State the conditions required for linear equilibrium.</li><li>Decide whether a system is in equilibrium.</li><li>Apply the first condition of equilibrium to solve problems.</li></ul>

Forces are all around us. From keeping us standing on the Earth, to the Earth moving around the Sun. We experience forces every day of our lives.

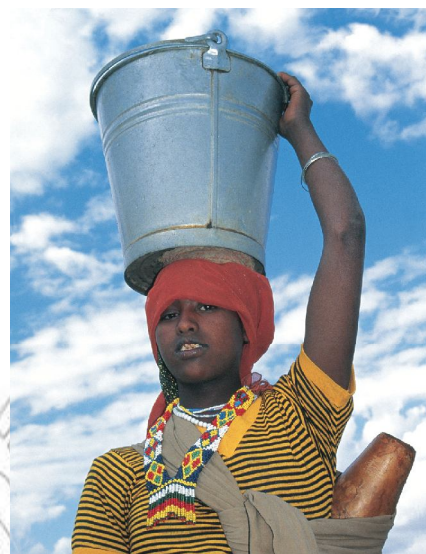
This unit looks at different types of forces, how they interact and what effect they have on motion. This is a large topic encompassing

some of the most important work ever carried out by Physicists. You will look into Newton's laws, Hooke's work on springs, and even learn how to calculate your mass and weight on different planets.

### 3.1 Forces in nature

By the end of this section you should be able to:

- List some of the forces that occur in nature and categorise them as contact or non-contact.
- State Newton's first law.
- Explain the relationship between mass and inertia.
- State Hooke's law and distinguish between elastic and inelastic materials.
- Experimentally determine and describe the force constant of a spring.



**Figure 3.1** Weight is a common force we experience every day.

#### What are forces?

In simple terms, a force is a **push** or a **pull**. You might push a book across the desk or gravity might pull objects towards the centre of the Earth.

There are plenty of different examples of forces. However, if you look deeper, forces fall into just four groups:

- Electromagnetic forces, dealing with charged objects, atomic interactions and whenever objects come into contact.
- Gravity, which relates to all objects that have mass, from an apple falling to the ground to the Earth orbiting the Sun.
- Finally, two forces dealing with interactions within the nucleus of atoms. These are called the strong nuclear force and the weak nuclear force. Although very important we rarely encounter these forces in our day to day lives.

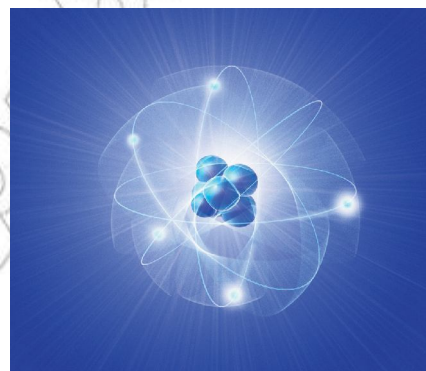
Below are some examples of common forces.

**Table 3.1** Some examples of forces

Friction	Drag forces (including air resistance and water resistance)
Electrostatic attraction or repulsion	Thrust
Buoyant force (upthrust)	Gravitational attraction
Weight	Tension
Contact force (reaction)	Magnetic attraction or repulsion

All forces are vector quantities. This means they all have both a **magnitude** and a **direction**, and are often represented in diagrams as arrows. The size of the arrow represents the magnitude of the force and the way it is pointing shows the direction it is acting. The SI derived unit of force is the newton (N).

Figure 3.4 on the next page, is called a **free body diagram**. These kinds of diagrams are really useful when dealing with forces. It



**Figure 3.2** Forces play an important role in keeping atoms together.

#### Activity 3.1: Categorising forces

Categorise all the forces listed in Table 3.1 as contact or non-contact.



**Figure 3.3** Forces pull stars together to form gigantic galaxies.



**DID YOU KNOW?**

All forces are measured in **newtons**, named after Sir Isaac Newton (more on him later). He was born in 1642 and in his famous book *Principia Mathematica* he made significant advances in understanding motion. He also developed key theories on gravity and optics, and invented an entire new branch of mathematics: calculus.

**KEY WORDS**

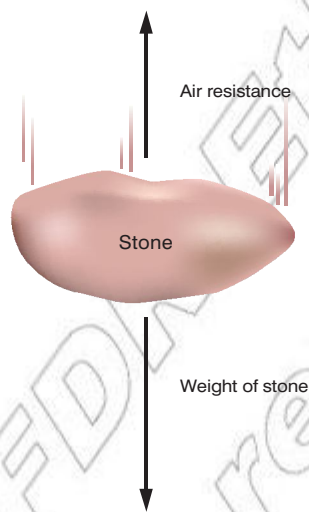
- pull** *movement towards a force*
- push** *movement away from a force*
- contact forces** *forces where objects must touch before the force has an effect*
- newton** *SI unit of force*
- non-contact forces** *forces where objects are not required to touch for the force to have an effect*

is important that you consider all the forces acting and draw the arrows approximately to scale. In this case the weight of the stone is greater than the air resistance.

**Contact or non-contact**

Forces can be categorised as either **contact** or **non-contact**. Some forces act over a distance and so the objects involved do not need to be touching. Other forces need objects to touch before their effects can be noticed.

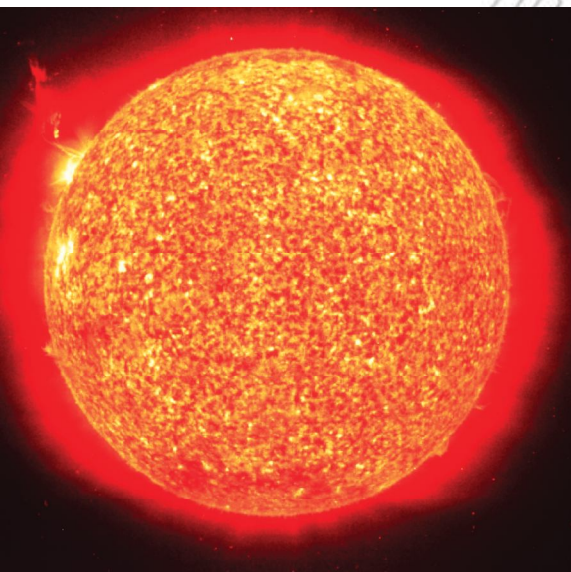
If you push your hands together you can feel a contact force (this is really an electrostatic repulsion between the electrons in the atoms in your hands). The same is true when you kick a ball.



**Figure 3.4** Forces acting on a stone falling through the air



**Figure 3.5** Kicking a ball demonstrates a contact force.



**Figure 3.6** Despite being 150 million km away the Sun's gravity still has a significant influence on the motion of the Earth.

Several forces act over a distance, the most obvious being gravitational attraction. The Earth is kept in orbit around the Sun even though they are 150 million km apart!

It is not just gravity; magnetic forces can also act over distances, for example, two magnets attracting each other.



**Figure 3.7** Magnets can attract or repel each other without being in contact.

**What effect do forces have?**

The famous ancient Greek, Aristotle, did a great deal to help develop the idea of science. However, he got forces all wrong! He thought that forces were needed to make objects move, that is, there cannot be any movement unless a force is acting.

This idea makes a lot of sense in our experience. If we push a block along it will keep on moving, but if we stop pushing the block it will slow down and stop. The problem is that on Earth whenever objects are in motion there are other forces acting, namely weight, friction and/or drag. These forces have an effect on the motion of the object.

It is true that forces and motion are linked but forces *do not simply make objects move*.

It was not until the famous English physicist, Sir Isaac Newton, came along, some 2000 years after Aristotle, that we developed a more complete understanding of forces. Newton took some of the ideas developed by Galileo and constructed three laws that describe how motion and forces are related.

Newton's first law of motion explains what effect forces have on objects. It states:

- **An object will remain at rest or travelling at a constant velocity unless acted upon by an external force.**

This takes a bit of reading but what it means is that forces don't make objects move but they do make objects change the way they are moving.

An object will remain at rest unless a force makes it start to move. It will then continue to move at the same velocity until another force slows it down. So using our block example from earlier, when we stop pushing it the block slows down because friction is acting on it. If there was no friction it would continue at the same velocity until another force acted on it.

The use of the term velocity here is also important. It means an object moving around a curve or in a circle must have a force acting on it. Whenever an object moves in a circle its velocity is changing (because velocity is a vector quantity) and so according to Newton's first law there must be a force acting on it.

Newton's first law means a force is always required to make an object:

- **speed up**
- **slow down**
- **or change direction.**

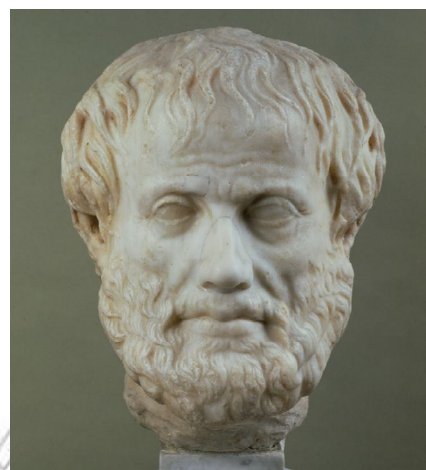
If an object is not doing any of these, then we can conclude there are no overall forces acting on it. This might mean remaining stationary but it also means travelling at a steady speed in a straight line.

### Mass and inertia

Newton's first law means that objects have a tendency to resist any changes to their motion. They will remain stationary or at constant velocity unless a force acts on them.

This is referred to as the **inertia** of an object. It is defined as:

- **The property of an object to remain at rest or moving at a steady speed in a straight line.**



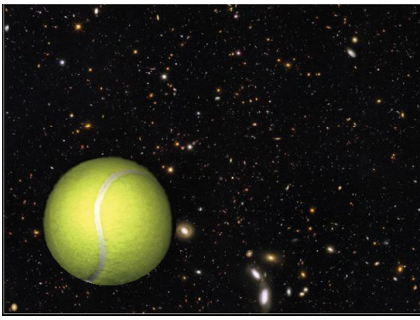
**Figure 3.8** Aristotle developed some excellent theories but his ideas about forces were wrong!



**Figure 3.9** Sir Isaac Newton – perhaps the greatest physicist of all time.

### Think about this...

Newton's first law means if you were to throw a tennis ball in space, far away from any stars and planets, it would continue to travel at a steady speed in a straight line forever! (Well until it got near another object and then its gravity would start to have an effect).



**Figure 3.10** With no friction or air resistance to slow it down, a ball thrown in space will travel at a steady speed in a straight line.

You may have experienced this on a bus or train. If you are standing still and the vehicle moves you tend to fall backwards. This is because as it moves your feet are pulled along due to friction, but the rest of your body resists this change in motion; it wants to stay at rest.

The same is true when the bus/train stops suddenly; you tend to 'fly forward'. You're not really flying forward, you just keep moving at the same speed as the vehicle slows down.

The inertia of an object depends on its mass. **The greater the mass of the object, the greater its inertia.**

This is why it is easy to kick a small stone. Because it has a small mass and so a small inertia, only a small force is required to change the motion of the stone. However, a large boulder has a great deal more mass. If you kicked a boulder chances are it wouldn't move (and you'd have a sore toe!). It has much more mass, so it has a much greater inertia and a much larger force is required to change its motion.

**KEY WORDS**

**inertia** the tendency of an object to resist changes to its motion

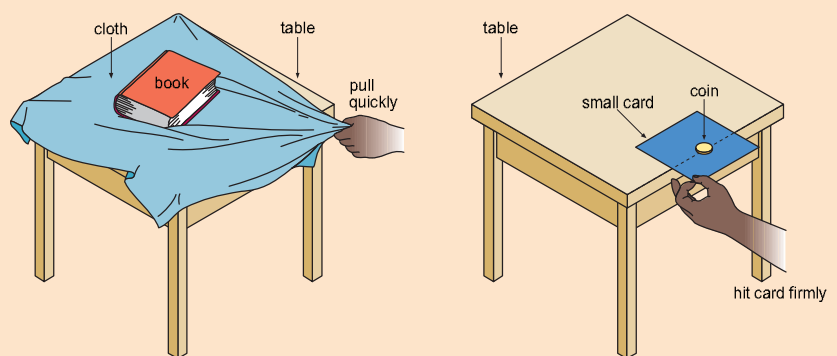


**Figure 3.11** The greater the mass the greater the inertia. The large boulder has a much greater inertia.

**Activity 3.2: Observing inertia**

Try these simple observations (Figure 3.12).

- Place a book on a cloth on a smooth table. Pull the cloth quickly. The book remains at rest.
- Place a coin on a small card. Support the card on the edges of a table so that its sides stick out. Hit the card firmly with one finger. The coin stays where it is.
- Put some water in a bucket or can. Spin it around quickly, in a vertical circle. Although the can is upside down at the top of the circle, no water falls out.



**Figure 3.12** Demonstrating inertia

**DID YOU KNOW?**

Inertia comes from the Latin word, "iners", meaning idle, or lazy. Newton used this word to illustrate that objects were lazy; they did not want to move unless a force was applied to them.

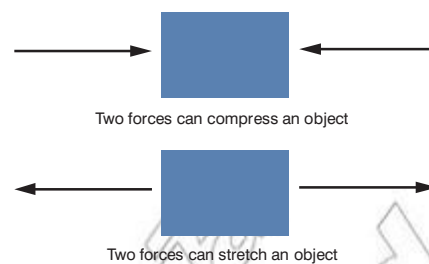
**Other effects of forces**

If more than one force acts on an object it can also *change the shape* of the object. Two parallel equal and opposite forces can either stretch or compress an object.

Forces can also twist or bend an object if applied in different directions.

Robert Hooke was another physicist working in London around the same time as Newton. He was investigating methods for making more precise clocks. He was interested in the effect forces had on springs.

Hooke used springs fixed at one end (this provided an upward force) and applied a force to the bottom of the spring to stretch it (this force is sometimes called the **load**).



**Figure 3.13** Some possible effects of two equal and opposite forces

### KEY WORDS

**load** a force applied to a spring

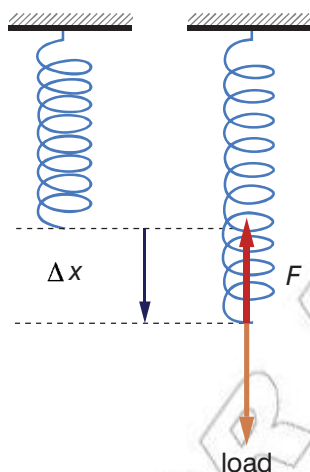
**extension** the increase in length of a spring

### DID YOU KNOW?

Hooke is perhaps best known for Hooke's law (also called the law of elasticity), but like Newton he made several other valuable contributions. He is often described as the father of microscopy, making several important discoveries. Hooke also came up with the term cell to describe the basic unit of life.



**Figure 3.14** Robert Hooke was a great scientist and was a rival of Isaac Newton.



**Figure 3.15** Applying a force to a spring fixed at one end causes it to extend.

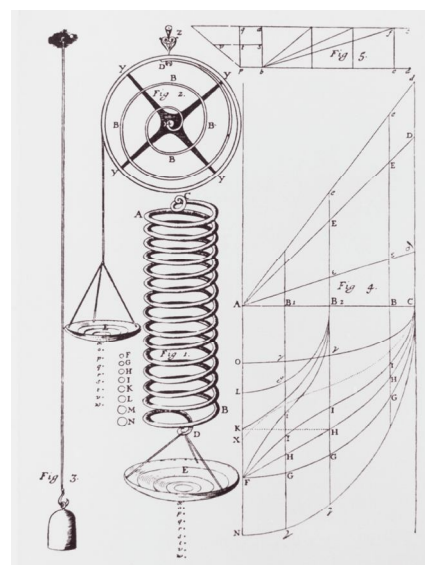
Hooke found that the greater the force applied to the spring the greater the **extension**. Not only that, he found that the extension of the spring was directly proportional to the force applied. This is often referred to as **Hooke's law**.

This means when he applied twice the force the spring would extend twice as far. Three times the force, the spring would extend three times as far.

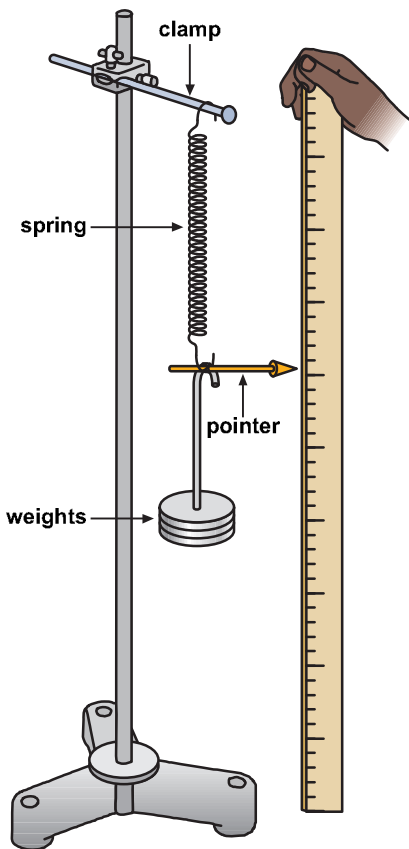
Hooke's experiments are easy to repeat in a lab. Figure 3.17 on the next page, shows a simple experimental arrangement you could use to test his findings.

**Table 3.2** Some results from an experiment on stretching a spring

Force applied (N)	Length of spring (cm)	Extension (cm)
0	10.0	0.0
1	11.5	1.5
2	13.0	3.0
3	14.5	4.5
4	16.0	6.0
5	18.5	8.5
6	22.0	12.0



**Figure 3.16** Some of Robert Hooke's original drawings of his experiment



**Figure 3.17** Investigating how force affects the extension of a spring

**Think about this...**

Extending twice as far does not mean the spring is now double its length. It just means the extension is twice the size. Take a spring 15 mm long; if 2 N caused a 3 mm extension then 4 N would cause a 6 mm extension. With a load of 4 N the spring would be 21 mm long.

**KEY WORDS**

**Hooke's Law** the force applied to a spring is directly proportional to its extension up to the elastic limit  
**directly proportional** a relationship where both variables increase (or decrease) at the same time

Plotting these results on a graph will produce one like that in Figure 3.18. With Hooke's law experiments it is not uncommon to see it the other way around, with extension plotted against force applied, so make sure you look carefully at the axis!

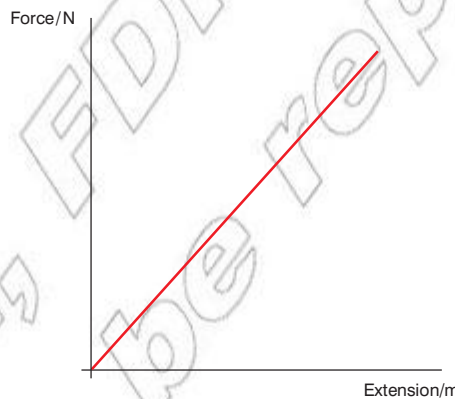
Any relationship that is **directly proportional** will produce a straight line graph with the line going through the **origin**. However, it is worth remembering it does not have to be at 45°. Figure 3.19 shows three directly proportional relationships.

Looking at Figure 3.19, what is different about the springs to produce different slopes? Some springs are stiffer than others. A stiffer spring will not extend as far when a force is applied to it. Looking at the graph, which is the stiffest spring?

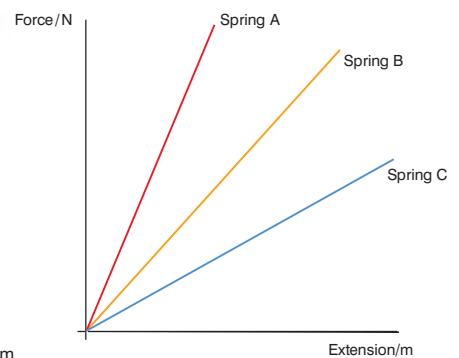
If you answered spring A you'd be correct. Spring C is the least stiff; it is the easiest to extend. Let's look at why, but this time just using two springs instead of three.

Figure 3.20 shows the results collected for two different springs. Spring A is stiffer than spring B.

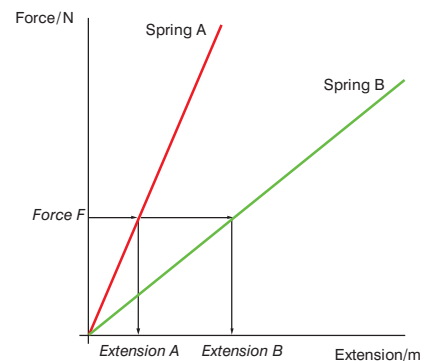
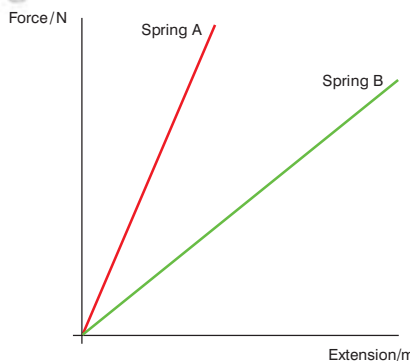
Consider the same force applied to each spring – force  $F$ . You can see from the second graph that this force causes spring B to extend more than spring A. Therefore you can conclude that spring A is stiffer than spring B.



**Figure 3.18** A graph showing that force is directly proportional to extension



**Figure 3.19** Three directly proportional relationships for three different springs



**Figure 3.20** Results collected for two different springs

The **spring constant** is a measure of the **stiffness** of a spring. It is given the symbol  $k$ . A stiff spring might have a spring constant of 1000 N/m and a less stiff spring might have a spring constant of 15 N/m.

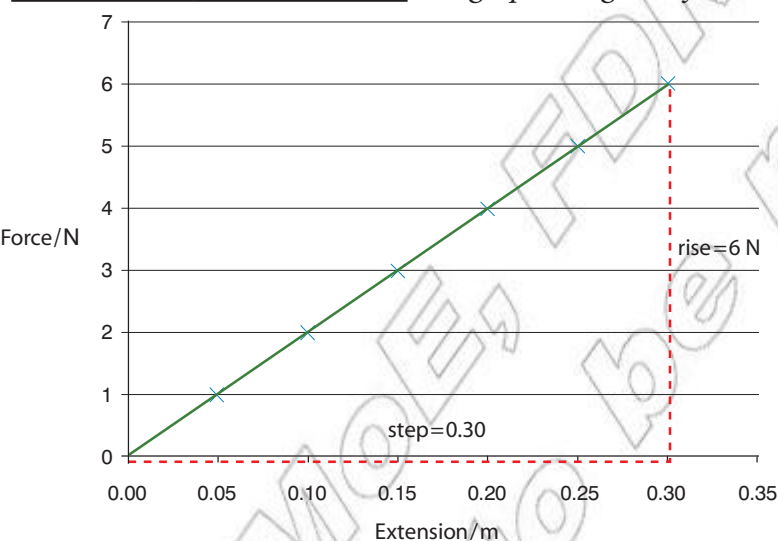
You can determine the spring constant of any given spring by using the force–extension graph.

The **gradient** of the line is equal to the spring constant. The steeper the line, the higher the gradient, the greater the spring constant and the stiffer the spring!

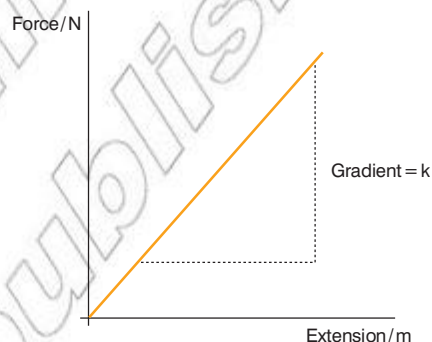
Using the data and graph below we can determine the spring constant for the spring.

**Table 3.3** Typical force and extension data

Force (N)	Extension (m)
0	0.00
1	0.05
2	0.10
3	0.15
4	0.20
5	0.25
6	0.30



**Figure 3.23** Force–extension graph using data from Table 3.3



**Figure 3.21** Using a force–extension graph to determine the spring constant

The gradient of the line = rise/step *State principle or equation to be used (determine the gradient of the line)*

gradient = 6 N / 0.3 m *Substitute in known values and complete calculation*

gradient = 20 N/m *Clearly state the answer with unit*

Therefore,  $k = 20$  N/m. *Make clear the gradient is also equal to k*

### Spring balances

The relationship between force and extension is used to great effect in **spring balances**. These are very simple devices designed to measure forces. They are often used to determine the weight of an object.

### Think about this...

The spring constant of 15 N/m means you would need to apply a force of 15 N to extend the spring by 1 m. 30 N would cause an extension of 2 m, etc. If  $k = 1000$  N/m, then 1000 N would be needed to extend the spring by 1 m. 500 N would cause a 50 cm extension, etc.



**Figure 3.22** The springs used in car suspension systems need to have a high spring constant.

### KEY WORDS

**origin** the point of intersection of the axes of a graph



Figure 3.24 Two different examples of spring balances

**DID YOU KNOW?**

Spring balances are often called newtonmeters (or forcemeters). That definitely would not have pleased Hooke! He and Newton were scientific rivals and did not get on at all well.

**Think about this...**

What would be different about the spring constant of a spring in a spring balance used to weigh heavy objects?

**KEY WORDS**

**gradient** the slope of a line on a graph

**spring balance** device used to measure force via the extension of a spring

**spring constant** a measure of the stiffness of a spring

**stiffness** the amount of force required to stretch or compress a spring

Spring balances work on the principle that the greater the force applied the greater the extension. This means it is easy to construct a simple scale and pointer next to the spring. When a force is applied (e.g. the weight of an object) the spring will extend to a pre-determined length.

**Activity 3.3: Making a spring balance**

You can make a spring balance of your own.

- You need a spring, and a container for the objects you are going to weigh (Figure 3.25).
- You also need a scale, next to the spring. Make a cardboard pointer, and attach it to the bottom of the spring, so that it will move past the scale.
- First, you must **calibrate** the spring balance. Hang some known loads on the meter. Mark their values on the scale. Mark the scale in equal divisions.
- Now use your meter to weigh other objects.

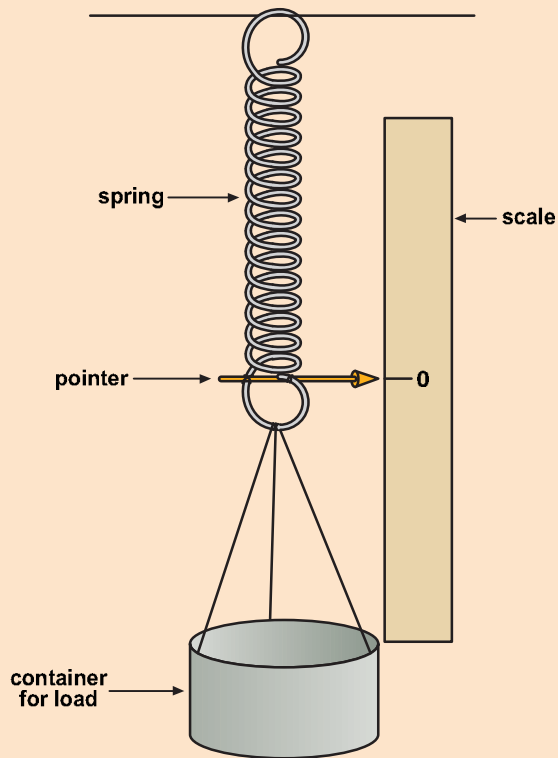


Figure 3.25 Making a spring balance

**The elastic limit**

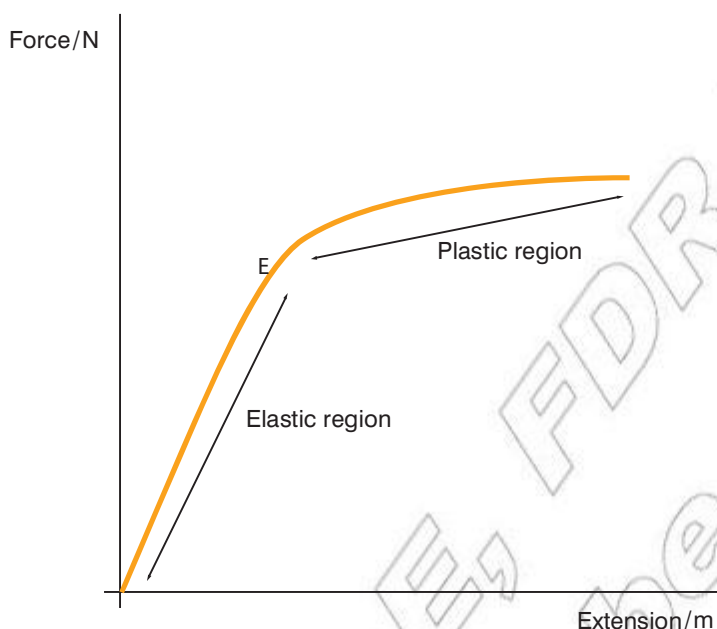
If we keep on applying force will the spring keep extending forever? Obviously at some point the spring will break, but before it does it behaves slightly differently. It begins to stretch more easily and eventually it will stretch so far that it will not return to its original length when the force is removed.

So far we have been dealing with what is called **elastic deformation** of the spring. This happens when the force applied to the spring is directly proportional to the extension and when you remove the force the spring returns to its original length.

A spring will only stretch elastically up to a certain point. This point is called the **elastic limit**. After this limit is reached the deformation is said to be **plastic**.

Plastic deformation means that the force is no longer proportional to the extension and when you remove the force the spring no longer returns to its original length; it has been permanently stretched.

The graph below shows you how to identify the two different types of deformation.



**Figure 3.26** Elastic and plastic deformation of a spring

$E$  on the graph is the elastic limit. Below the elastic limit the deformation is **elastic**. Above the elastic limit plastic deformation occurs.

Hooke's findings about springs led to the law of elasticity, which is more commonly called Hooke's law. This only applies if the spring is below its elastic limit and so may be written as:

- **The force applied is directly proportional to the extension of a spring up to the elastic limit.**

Different springs have different elastic limits depending on their shape, thickness, material, etc. All materials have an elastic limit; think about a wooden or plastic ruler. If you bend it a little bit it will return to its original length. If you apply too much force it will bend so far it snaps; you've gone beyond the elastic limit for the ruler.

### DID YOU KNOW?

The shorthand way of writing directly proportional is to use this symbol:  $\propto$ . This means we could write Hooke's law as  $F \propto \Delta x$  up to the elastic limit.

### KEY WORDS

**calibrate** to compare a measuring device with a known standard

**elastic deformation** where the force applied is directly proportional to the extension and where the object will return to its original length when the force is removed

**elastic limit** the point up to which a spring will stretch elastically

**plastic deformation** where the force applied is not directly proportional to the extension and where the object will not return to its original length when the force is removed



### Summary

In this section you have learnt that:

- Forces can either be classed as contact or non-contact. Examples of forces include friction, drag, weight, gravitational attraction and contact forces.
- Newton's first law states: "An object will remain at rest or travelling at a constant velocity unless acted upon by an external force".
- Inertia is the tendency of an object to resist changes to its motion. The greater the mass of an object the greater its inertia.
- Hooke's law states: "The force applied to a spring is directly proportional to the extension of the spring up to the elastic limit".
- The stiffer the spring the greater the spring constant ( $k$ ; measured in N/m).
- Elastic deformation means when forces are removed the object will return to its original length. Plastic deformation means when the forces are removed the object does not return to its original length; it is permanently stretched.

### Review questions

1. Give some examples of forces and classify them as contact or non-contact.
2. State Newton's first law and explain what it means.
3. Describe Hooke's law and define the following terms: elastic deformation, elastic limit and plastic deformation.
4. Sketch two force vs. extension graphs, one for a stiff spring the other for a much weaker spring.

### 3.2 Newton's second law

By the end of this section you should be able to:

- Distinguish between resultant force and equilibrant force.
- Describe the effect of a force acting on a body.
- Apply Newton's second law (as  $F_{net} = ma$ ) to solve problems.
- Resolve forces into rectangular components and compose forces acting on a body using component methods.
- Describe the terms weight and weightlessness (including distinguishing between weight and apparent weight).
- Calculate the weight and apparent weight of an object in a range of situations.

## What if more than one force is acting?

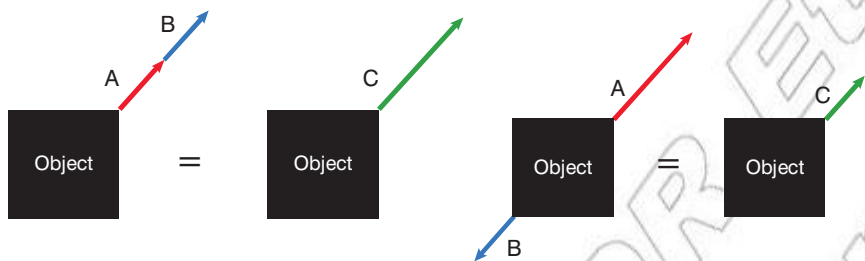
There are often several forces acting on an object. As all forces are **vector** quantities we can add them up using the techniques covered in Unit 1.

The overall force acting on any object is referred to as the **resultant force**. This is often called the net force or  $F_{net}$ . It is defined as:

- **The vector produced when two or more forces act upon a single object.**

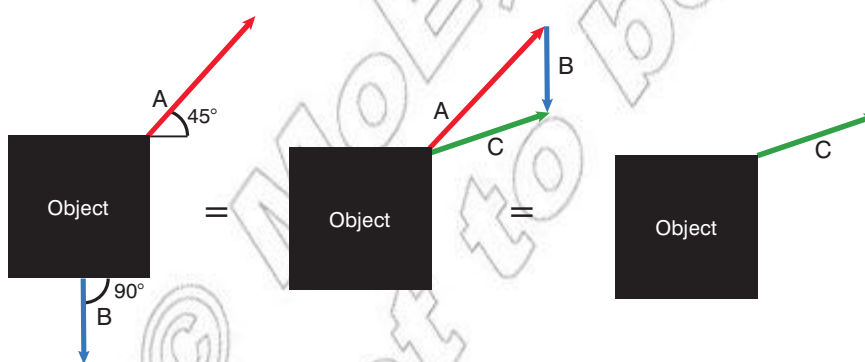
It is calculated by vector addition of the forces acting upon the object.

For example, consider two forces A and B acting on an object. They will produce a resultant force. In the two examples below forces A and B give rise to a resultant, force C.



**Figure 3.27** Different resultant forces acting on an object

If the forces are parallel it is easy to determine the resultant vector. However, if the forces are not parallel (as in Figure 3.28) we then use scale diagrams, parallelogram rules or the mathematical techniques covered in Unit 1 to determine the magnitude and direction of the resultant force.



**Figure 3.28** Non-parallel forces leading to a resultant force

Sometimes it is helpful to know the **equilibrant force**. This is the force you need to apply to a system to cancel out the resultant force. This will result in there being no net force acting on an object.

**Figure 3.30** An equilibrant force will cancel out the resultant force acting on an object.

## KEY WORDS

**equilibrant force** *the force required to cancel out the resultant force*

**resultant force** *the overall force acting on an object*

## DID YOU KNOW?

The equilibrant force for any system is always equal in magnitude to the resultant force but it acts in the opposite direction. This just cancels out the effect of the resultant force. This can be written as:  $F_{net} = -F_{equilibrant}$



**Figure 3.29** There are several forces acting on an aircraft in flight.



## Worked example

Two forces are acting on a boat. One force of 400 N is due to current in the river, acting downstream. The other force due to the propeller has a magnitude of 500 N and acts at an angle of  $50^\circ$  to the river bank. Determine the resultant force acting on the boat.



Figure 3.31 Boat crossing a river

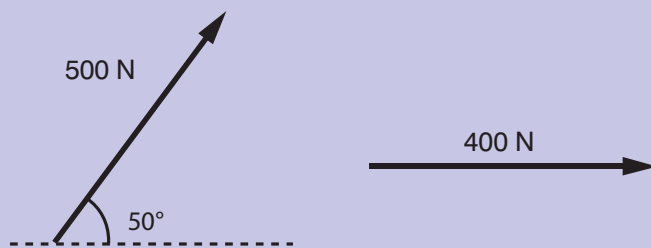


Figure 3.32 Two force vectors acting on the boat

We could determine the resultant force using a **scale diagram**. However, on this occasion we are going to find the resultant force mathematically.

In order to determine the resultant force we must first **resolve** the 500 N into horizontal and vertical components using trigonometry.

- Vertical component:  
 $\sin \theta = \text{opp} / \text{hyp}$  *State principle or equation to be used (trigonometry)*  
 $\text{hyp} \times \sin \theta = \text{opp}$  *Rearrange to make the opp side the subject*  
 $500 \text{ N} \times \sin 50^\circ = 383 \text{ N} \uparrow$ . *Substitute in known values and complete calculation, then clearly state the answer with unit*
- Horizontal component:  
 $\cos \theta = \text{adj} / \text{hyp}$  *State principle or equation to be used (trigonometry)*  
 $\text{hyp} \times \cos \theta = \text{adj}$  *Rearrange to make the adj side the subject*

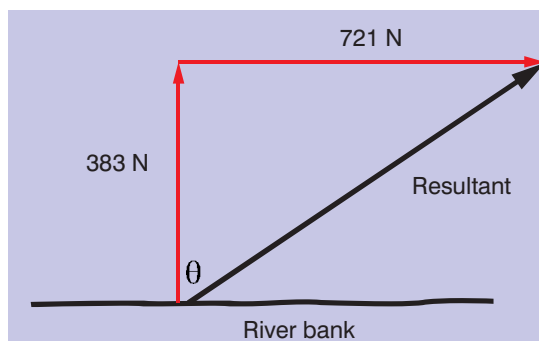
$500 \text{ N} \times \cos 50^\circ = 321 \text{ N} \rightarrow$ . *Substitute in known values and complete calculation, then clearly state the answer with unit*

We can then add the horizontal forces to give the resultant horizontal force.

- Resultant horizontal force:  
 $F_{\text{net horizontal}} = 321 \text{ N} \rightarrow + 400 \text{ N} \rightarrow$  *Determine the net horizontal force (note the directions)*  
 $F_{\text{net horizontal}} = 721 \text{ N} \rightarrow$ . *Clearly state the answer with unit*

We can then use **Pythagoras's theorem** to determine the magnitude of the resultant force and **trigonometry** to determine the direction.

- Magnitude of resultant force:  
 $F_{\text{net horizontal}} = 721 \text{ N} \rightarrow$  *Clearly state known values*  
 $F_{\text{net vertical}} = 383 \text{ N} \uparrow$  *Clearly state known values*  
 $F_{\text{net}} = 383 \text{ N} \uparrow + 721 \text{ N} \rightarrow$  *Determine the net force (note the directions)*  
 $F_{\text{net}}^2 = 383^2 + 721^2$  *Apply Pythagoras's theorem*  
 $F_{\text{net}}^2 = 666\,530$  *Solve for  $F_{\text{net}}^2$*   
 $F_{\text{net}} = \sqrt{666\,530}$  *Rearrange for resultant (take square root) and solve*  
 $F_{\text{net}} = 816 \text{ N}$  *Clearly state the answer with unit*
  - Direction of resultant force:  
 $F_{\text{net horizontal}} = 721 \text{ N} \rightarrow$  *Clearly state known values*  
 $F_{\text{net vertical}} = 383 \text{ N} \uparrow$  *Clearly state known values*  
 $\tan \theta = \text{opp} / \text{adj}$  *State principle or equation to be used (trigonometry)*  
 $\theta = \tan^{-1}(\text{opp} / \text{adj})$  *Rearrange equation to make  $\theta$  the subject*  
 $\theta = \tan^{-1}(721 / 383)$  *Substitute in known values and complete calculation*  
 $\theta = 62^\circ$  *Clearly state the answer with unit*
- This is the angle between the resultant and the vertical component. The angle between the resultant force and the river bank is  $90^\circ - 62^\circ = 28^\circ$ .



**Figure 3.33** Determining the resultant force

In this situation the equilibrant force would be 816 N acting in the opposite direction to the resultant force.

## Forces and acceleration

In the previous section we said: Newton's first law means a force is required to make an object:

- **speed up**
- **slow down**
- **change direction.**

If an object does any of these things we can say it is **accelerating**. In other words, forces cause objects to accelerate, or more precisely if there is a resultant force acting on an object, then that object will accelerate. The forces are said to **unbalanced**.

If there are **balanced forces** acting on an object then there is no resultant force and so the object will not accelerate.



### KEY WORDS

**trigonometry** a type of mathematics that deals with the relationships between the sides and angles of triangles

**accelerating** where an object is speeding up, slowing down or changing direction

**balanced forces** where the forces acting on a body cancel each other out and there is no resultant force

**inversely proportional** a relationship where one variable increases as the other decreases and vice versa

**unbalanced forces** where the forces acting on a body do not cancel out and there is a resultant force

**Figure 3.34** Any object going around a bend is accelerating; the forces are unbalanced and so there must be a resultant force acting on it.

Newton's second law relates to the rate of change of momentum of an object (more on this later). He realised that whenever a resultant force acts on an object it will accelerate and this acceleration takes place in the same direction as the force. If you push an object to the left it will accelerate towards the left.

Through careful experiment and investigation he also worked out that if you double the resultant force then the acceleration of the object will also double. In other words the force applied is directly proportional to the acceleration (as long as everything else remains constant).

He also determined that the acceleration of the object also depends on the object's mass. The greater the mass the greater the inertia, and so the lower the acceleration. In fact if you double the mass the acceleration will halve and vice versa. An object with a quarter of the mass will accelerate at four times the rate if the same force is applied. This relationship is called **inversely proportional**. As one quantity doubles the other halves.

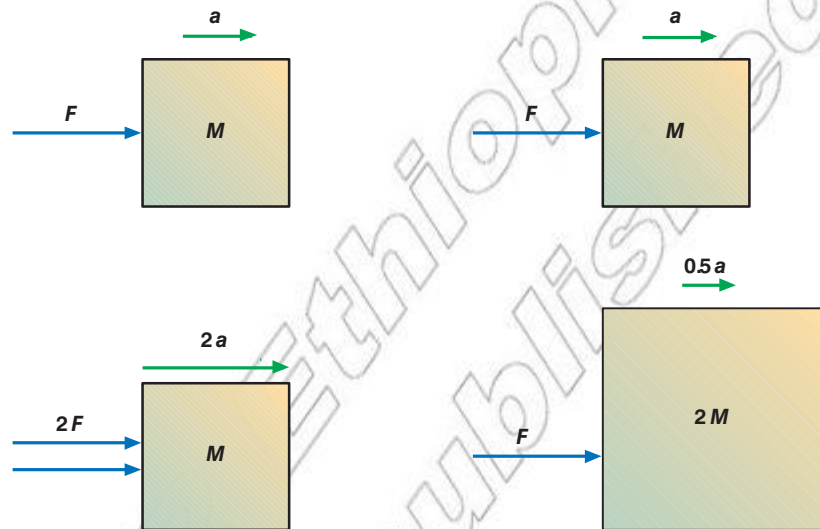


Figure 3.35 The effects of force and mass on acceleration

As long as the mass of the object remains constant then Newton's second law can be expressed as:

- The acceleration of an object is directly proportional to the resultant force acting on the object.

and

- This acceleration occurs in the direction of the resultant force.

(Remember, this only applies if the mass of the object is constant.)

This gives us:

Resultant force = mass of object  $\times$  acceleration of object

$$F_{net} = ma$$

We can use this equation to determine the resultant force required to make a car of mass 1200 kg accelerate at 2 m/s<sup>2</sup>.

Resultant force = mass of object  $\times$  acceleration of object *State principle or equation to be used (Newton's second law)*

$$F_{net} = ma$$
 *Simplify statement to symbols*

$$F_{net} = 1200 \text{ kg} \times 2 \text{ m/s}^2$$
 *Substitute in known values and complete calculation*

$$F_{net} = 2400 \text{ N}$$
 *Clearly state the answer with unit*

We can use the equation to determine the acceleration of a soccer ball if we know the applied resultant force. A footballer may strike a ball of mass 400 g with a force of 200 N.



Figure 3.36 When you apply the brakes on a bike a force is generated in the opposite direction to motion. You accelerate in this direction and so slow down.



Figure 3.37 The greater the force applied to the ball the greater its acceleration.

$F_{net} = ma$  *State principle or equation to be used (Newton's second law)*

$a = F_{net} / m$  *Rearrange equation to make a the subject*

$m = 400 \text{ g}$ , which is  $0.4 \text{ kg}$  *Ensure all values are in SI units*

$a = 200 \text{ N} / 0.4 \text{ kg}$  *Substitute in known values and complete calculation*

$a = 500 \text{ m/s}^2$  *Clearly state the answer with unit*

This acceleration will be in the same direction as the resultant force.

### $F_{net} = ma$ with several forces

If several forces are acting on an object then in order to determine its acceleration we must first determine the resultant force.

To determine the acceleration we would use  $F_{net} = ma$ .

$F_{net} = ma$  *State principle or equation to be used (Newton's second law)*

$a = F_{net} / m$  *Rearrange equation to make a the subject*

The resultant force in Figure 3.38 is  $30 \text{ N}$  → *Determine resultant by simple calculation of net force*

$a = 30 \text{ N} / 4.0 \text{ kg}$  *Substitute in known values and complete calculation*

$a = 7.5 \text{ m/s}^2$  to the right *Clearly state the answer with unit*

To determine the acceleration we would again use  $F_{net} = ma$ . Except in this case we must subtract the forces to determine the resultant force.

$F_{net} = ma$  *State principle or equation to be used (Newton's second law)*

$a = F_{net} / m$  *Rearrange equation to make a the subject*

The resultant force in Figure 3.39 is  $20 \text{ N}$  → *Determine resultant by simple calculation of net force*

- $a = 20 \text{ N} / 2.0 \text{ kg}$  *Substitute in known values and complete calculation*

- $a = 10 \text{ m/s}^2$  in the direction of the  $50 \text{ N}$  force *Clearly state the answer with unit*

This process can be repeated for forces at an angle and for problems involving more than two forces.

If you know the acceleration of the object you can also determine the magnitude and direction of the resultant forces. For example, two people are pushing a  $60 \text{ kg}$  trolley along. One applies a force of  $40 \text{ N}$  and the trolley accelerates at  $2.0 \text{ m/s}^2$ . Determine the size of the force applied by the other person.

$F_{net} = ma$  *State principle or equation to be used (Newton's second law)*

$F_{net} = 60 \text{ kg} \times 2 \text{ m/s}^2$  *Substitute in known values and complete calculation*

$F_{net} = 120 \text{ N}$  *Clearly state the answer with unit*

The resultant force is  $120 \text{ N}$ .

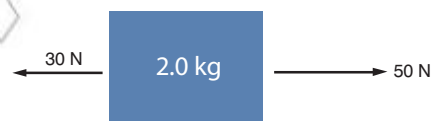
$F_{net} = F_1 + F_2$  *Express net force in terms of  $F_1$  and  $F_2$*

### DID YOU KNOW?

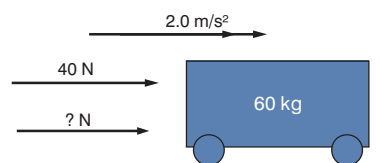
Newton's second law may be used to define the newton as the unit of force. Using  $F_{net} = ma$  and making sure the units are all correct (force in N, mass in kg and acceleration in  $\text{m/s}^2$ ), we can say that a force  $1 \text{ N}$  is the force required to give a mass of  $1 \text{ kg}$  an acceleration of  $1 \text{ m/s}^2$ . Or  $1 \text{ N}$  is equivalent to  $1 \text{ kg m/s}^2$ .



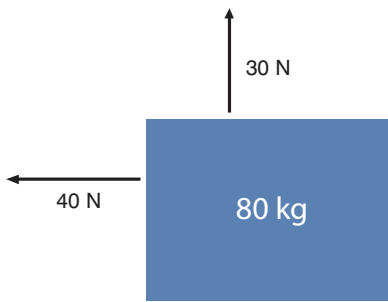
**Figure 3.38** Two forces acting on an object



**Figure 3.39** Two forces acting on an object in different directions



**Figure 3.40** Trolley being pushed by two people



**Figure 3.41** Two forces acting on an object at right angles

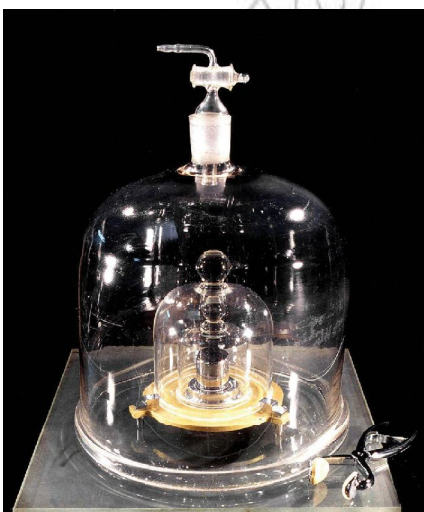
### KEY WORDS

**mass** a measure of the quantity of matter

**weight** the force experienced by an object due to the gravitational pull of the Earth

### DID YOU KNOW?

The kilogram is defined as the same amount of mass as the international prototype kilogram. This is a platinum–iridium block held in Paris, France.



**Figure 3.42** The international prototype kilogram has a mass of exactly **one** kilogram.

$$120 \text{ N} = 40 \text{ N} + F_2 \text{ Substitute in known values and complete calculation}$$

$$F_2 = 80 \text{ N} \rightarrow \text{Clearly state the answer with unit}$$

The same technique may be used to determine the acceleration of an object with two forces acting on it at right angles. For example:

First we must determine the resultant force using Pythagoras's theorem.

$$a^2 = b^2 + c^2 \text{ State principle or equation to be used (Pythagoras's theorem)}$$

$$F_{\text{net}}^2 = (40 \text{ N})^2 + (30 \text{ N})^2 \text{ Substitute in known values}$$

$$F_{\text{net}}^2 = 2500 \text{ Solve for } F_{\text{net}}^2 \text{ then solve for } F_{\text{net}} \text{ by taking square root}$$

$$F_{\text{net}} = 50 \text{ N} \text{ Clearly state the answer with unit}$$

Then using  $F = ma$  we get:

$$a = F_{\text{net}} / m \text{ Rearrange } F = ma \text{ to make } a \text{ the subject}$$

$$a = 50 \text{ N} / 80 \text{ kg} \text{ Substitute in known values and complete calculation}$$

$$a = 0.63 \text{ m/s}^2 \text{ Clearly state the answer with unit}$$

Trigonometry should then be used to determine the direction of this acceleration; this is in the same direction as the result force ( $37^\circ$  to the horizontal – check it for yourself).

## Mass and weight

**Mass** and **weight** are two terms that are frequently confused. We often say we are going to weigh something and then record its mass in kg!

We must make sure we don't muddle the two; they are very different.

Mass is a scalar quantity and it is a measure of the quantity of matter. The more mass the more stuff (the more matter). Remember the inertia of an object depends on its mass, you can think of mass as a measure of an object's inertia. Mass is measured in kilograms (kg).

Weight is a force and so it's a vector quantity, measured in newtons (N). It is the force we experience due to the gravitational pull of the Earth pulling on our mass. Weight is directed towards the centre of the Earth.

We can calculate the weight of an object using:

- weight = mass  $\times$  gravitational field strength
- $w = mg$

On the surface of the Earth the gravitational field strength is around 9.81 N/kg. We will use 10 N/kg in the following examples to make the mathematics a little easier.

A person with a mass of 70 kg will have a weight of:

$$w = mg \text{ State principle or equation to be used}$$

$$w = 70 \text{ kg} \times 10 \text{ N/kg} \text{ Substitute in known values and complete calculation}$$

$w = 700 \text{ N}$  (actually more like  $687 \text{ N}$  if we use  $g = 9.81 \text{ N/kg}$ ).

*Clearly state the answer with unit*

If the gravitational field strength changes then the weight of the object will change but its mass will stay the same. The gravitational field strength varies a little around the Earth. This is for two reasons.

Firstly the amount of mass between you and the centre of the Earth changes depending on where you are. If there is a particularly dense pocket of material underneath you this will increase the gravitational field strength slightly. The reverse is also true, if there is large pocket of gas or lower density material underneath you the gravitational field strength will go down.

The distance from the centre of the Earth also affects  $g$ ; it gets smaller the further away from the centre of Earth you get. This change is quite small, you need to move really far away before it becomes noticeable. Even at the top of the tallest mountain  $g$  is still around  $9.8 \text{ N/kg}$ .

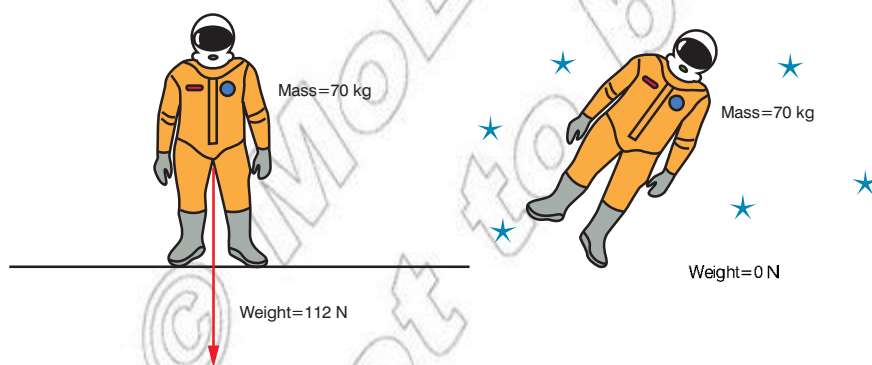
Remember, only the weight of the object will change; its mass will stay the same. This is also true if we consider different planets. Taking our astronaut as an example, if he stands on the Moon his mass is still  $70 \text{ kg}$  (there is still the same amount of matter). However, on the Moon the gravitational field strength is much less than that on Earth. This is because the Moon has much less mass and so a weaker gravitational field. The value for  $g$  on the moon is just  $1.6 \text{ N/kg}$ .

His weight on the Moon would be:

$w = mg$  *State principle or equation to be used*

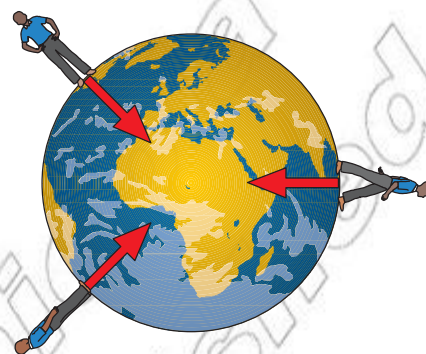
$w = 70 \text{ kg} \times 1.6 \text{ N/kg}$  *Substitute in known values and complete calculation*

$w = 112 \text{ N}$  *Clearly state the answer with unit*

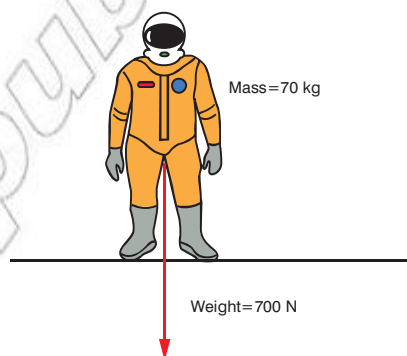


**Figure 3.45** Astronaut on the Moon and in deep space

In deep space, far away from any planets and stars, the gravitational field strength is pretty much zero. In this case his mass would still be  $70 \text{ kg}$ . However, his weight would be  $0 \text{ N}$ ; he is weightless.



**Figure 3.43** Weight pulls all objects towards the centre of the Earth.



**Figure 3.44** Weight and mass

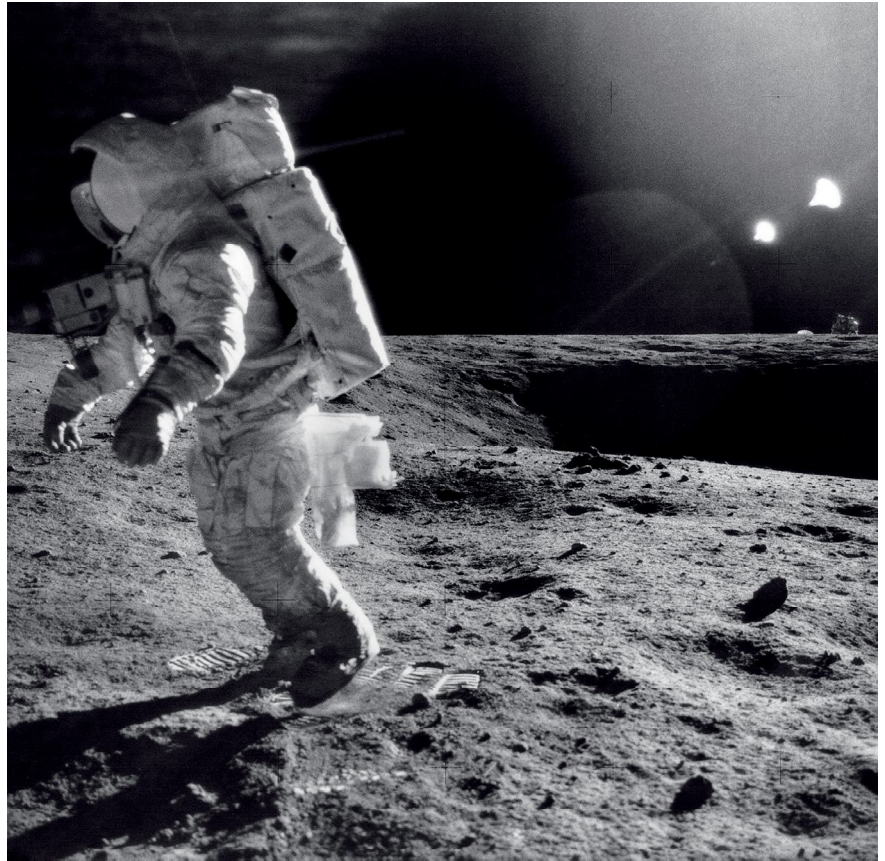
### Think about this...

The value for gravitational field strength is the same value as the acceleration due to gravity ( $9.81$ ). This can be shown by considering an object of mass  $m$  dropped from a height above the ground. From Newton's second law we know the acceleration will be equal to  $a = F_{\text{net}} / m$ . We also know the force accelerating the object is the weight of the object so we could write  $F_{\text{net}} = mg$ . Combining these two equations gives us:  $a = mg / m$ , the  $m$ 's cancel giving  $a = g$ !



**DID YOU KNOW?**

Slight variations in the gravitational field strength are used to look for oil and gas deposits. Because the oil and gas is less dense than the surrounding rock this causes a small dip the gravitational field strength above the deposit. This dip may be detected with sensitive equipment.



*Figure 3.46 Astronauts on the Moon can carry very large packs due to the Moon's weak gravity.*

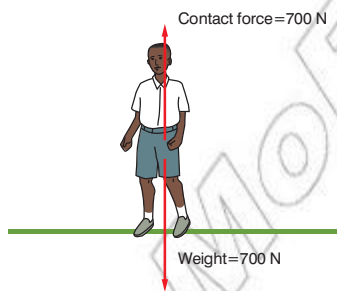


*Figure 3.47 Astronauts in the International Space Station are not truly weightless.*

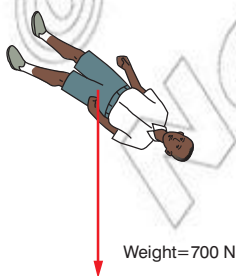
**True weightlessness and apparent weightlessness**

You are only truly weightless if the gravitational field strength is zero. Even astronauts in orbit around the Earth are not truly weightless. There is still a gravitational pull due to the Earth; they still have a weight. So why do they float around?

When we are standing on the ground our weight pulls us vertically downwards towards the centre of the Earth. We push down on the Earth and the Earth pushes back up with a contact force. These two forces cancel out so there is no resultant force (this is why we don't accelerate towards the centre of the Earth; if the ground was not there then we would!).



*Figure 3.48 Weight and contact force cancel out*



*Figure 3.49 This diver would experience apparent weightlessness for a brief period of time.*

It is this contact force we feel. We don't notice the pull of gravity. If you take this contact force away by jumping off a tall diving board, our weight accelerates us downwards but we don't feel it. It feels like we are weightless, but we are not!

- **Apparent weightlessness is when the only force acting is your weight.**
- **Real weightlessness is when your weight is zero.**

You get a similar feeling when a car goes over a humpback bridge or when an aircraft climbs or descends. We notice the change in the contact force and this makes us feel like our weight has changed.

Another common example is when you are in a lift. If the lift is not accelerating the two forces are equal, as shown in Figure 3.51.

If the lift accelerates upwards then there must be a net force acting on it. A net force also needs to act on you as you are inside the lift! Imagine the net force acting on you is 200 N (assuming your mass is 70 kg this would give an acceleration of  $2.86 \text{ m/s}^2$ ).

The floor would push you up harder; the contact force would have to increase to 900 N. This provides the extra 200 N. You feel heavier, even though your weight has not changed. It would feel like your weight is 900 N. This is referred to as your **apparent weight**; your **real weight** is still 700 N.

The same is true if the lift were to accelerate downwards. Again imagine the net force on you is 200 N. In this case the contact force would drop 200 N to 500 N. You would feel like your weight has dropped! Your apparent weight would be 500 N.

You can use Newton's second law to determine your apparent weight in an accelerating lift. Taking a person of mass 55 kg then their weight would be:

$$w = mg \text{ State principle or equation to be used}$$

$$w = 55 \text{ kg} \times 10 \text{ N/kg} \text{ Substitute in known values and complete calculation}$$

$$w = 550 \text{ N} \text{ Clearly state the answer with unit}$$

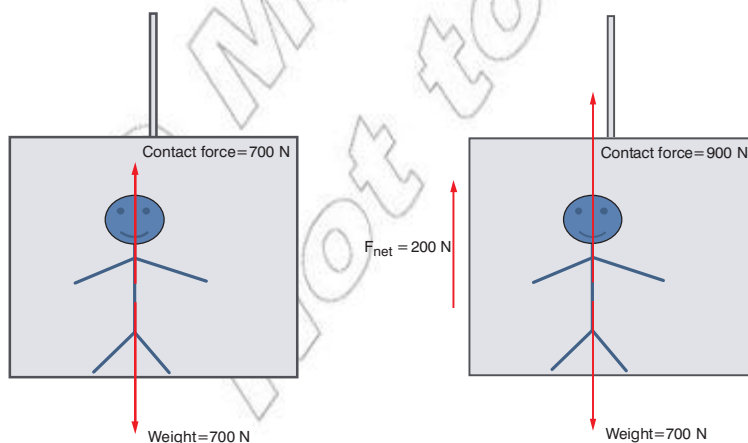
If this person is in a lift accelerating vertically upwards at  $2 \text{ m/s}^2$  then the net force acting on the person would be:

$$F_{\text{net}} = ma \text{ State principle or equation to be used (Newton's second law)}$$

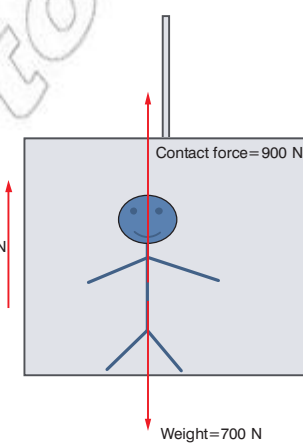
$$F_{\text{net}} = 55 \text{ kg} \times 2 \text{ m/s}^2 \text{ Substitute in known values and complete calculation}$$

$$F_{\text{net}} = 110 \text{ N} \text{ Clearly state the answer with unit}$$

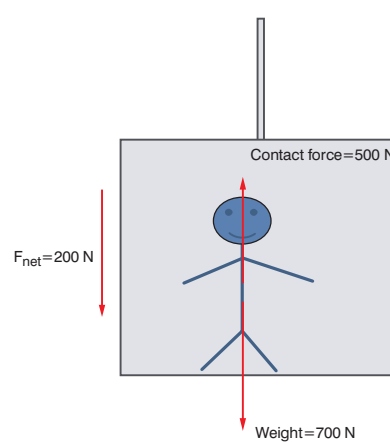
This force would come from an increase in the contact force. The contact force would have to go up to 660 N ( $550 \text{ N} + 110 \text{ N}$ ). This would be your apparent weight.



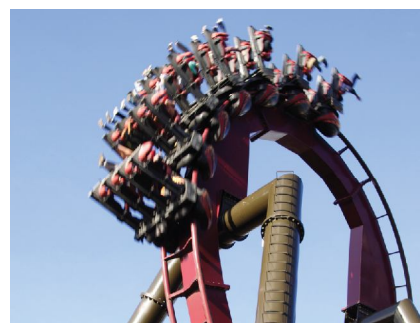
**Figure 3.51** Contact force and weight in a stationary lift.



**Figure 3.52** Accelerating upwards requires a net vertical force.



**Figure 3.53** Accelerating downwards requires a net vertical force. This time you would feel like your weight has dropped.



**Figure 3.50** The contact force we experience changes dramatically on an exciting roller coaster ride.

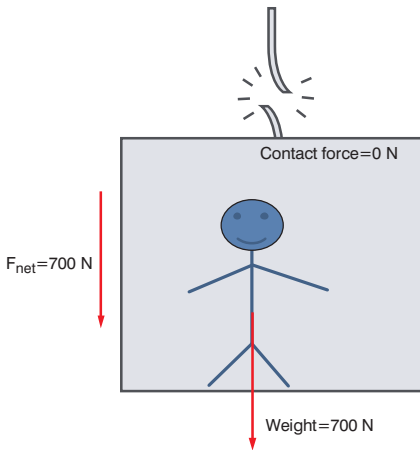
### Think about this...

You only notice this effect when the lift accelerates. When the lift is travelling at a steady speed the forces are balanced again (from Newton's first law).

### KEY WORDS

**apparent weight** the resultant of an object's real weight and any contact forces acting on the object

**real weight** the force experienced by an object solely due to the gravitational pull of the Earth



**Figure 3.54** If the contact force is zero you would be apparently weightless.

**DID YOU KNOW?**

As part of astronaut training trainees take a flight in an aircraft commonly called the Vomit Comet! This aircraft accelerates downwards at  $9.81 \text{ m/s}^2$ ; this means the contact force inside the aircraft falls to zero. All the occupants become apparently weightless for around 30 s (until the aircraft needs to pull up again).

If the lift was accelerating downwards at  $2 \text{ m/s}^2$  then your apparent weight would be 440 N. This would give a net force vertically downwards equal to 110 N.

If the lift cable were to snap then as the lift accelerates towards the ground the contact force would fall to zero! The floor would stop pushing you up. You would feel like you are weightless. Your apparent weight would be 0 N; you would be apparently weightless.



**Figure 3.55** A photo of the infamous 'Vomit Comet'

**$F_{net} = ma$  considering the weight of the object**

We must always think carefully when solving  $F_{net} = ma$  problems. Take for example a rocket of mass 15 000 kg. If the engines provide a force of 200 000 N what would its acceleration be?

- $F_{net} = ma$
- $a = F_{net} / m$
- $a = 200\,000 \text{ N} / 15\,000 \text{ kg}$
- $a = 13.3 \text{ m/s}^2$

This is wrong! We've not used the **resultant force**. Remember **free body diagrams** really help to identify all the forces acting on an object.

You can see the resultant force is equal to:

$F_{net} = \text{force from engines} - \text{weight of rocket}$  *Express  $F_{net}$  in terms of all forces acting*

$F_{net} = 200\,000 \text{ N} - (15\,000 \text{ kg} \times 10 \text{ N/kg})$  *Substitute in known values*

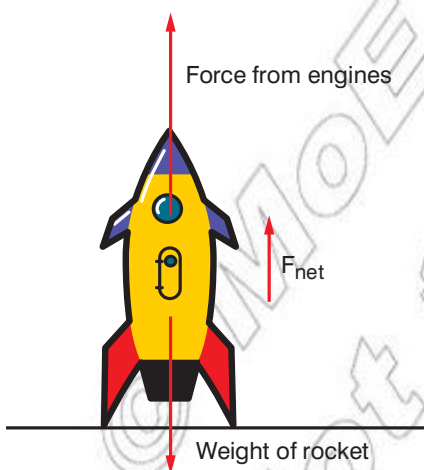
$F_{Net} = 200\,000 \text{ N} - 150\,000 \text{ N}$  *Solve calculation in brackets then complete calculation*

$F_{Net} = 5000 \text{ N}$  *Clearly state the answer with unit*

This would give us an acceleration equal to:

$F_{net} = ma$  *State principle or equation to be used (Newton's second law)*

$a = F_{net} / m$  *Rearrange equation to make a the subject*



**Figure 3.56** A free body diagram for the forces acting on a rocket at take off.

$a = 5000 \text{ N} / 15\,000 \text{ kg}$  *Substitute in known values and complete calculation*

$a = 0.3 \text{ m/s}^2$  *Clearly state the answer with unit*

We must always make sure we consider **all the forces** involved before determining the resultant force acting on an object.

## Summary

In this section you have learnt that:

- The overall force acting on an object is called the resultant force. The equilibrant force is the force that needs to be applied to cancel out the resultant force.
- A resultant force will cause an object to accelerate in the same direction as the resultant force.
- Newton's second law states: "Force is directly proportional to acceleration, as long as the mass remains constant, and the acceleration is in the same direction of the force". This gives us  $F_{net} = ma$ .
- In order to determine the resultant force, the forces acting on the object may need to be resolved then combined together again.
- Mass is a measure of the amount of matter measured in kg, whereas weight is a force measured in N caused by gravity pulling on an object's mass.

## KEY WORDS

**free body diagrams** are used to gain an understanding of the forces (or sometimes the fields) acting on an object

## DID YOU KNOW?

When large rockets take off their acceleration usually increases for the first few minutes of their flight. The acceleration starts off quite low then increases as the rocket burns fuel. This has a significant effect on its acceleration for two reasons. Firstly the weight drops and so this increases the resultant force acting and secondly as the object has less mass its acceleration will be greater (remember acceleration and mass are inversely proportional).

## Review questions

1. Explain what is meant by the terms resultant force and equilibrant force.
2. Describe Newton's second law.
3. Copy and complete Table 3.4.

Table 3.4

Force (N)	Mass (kg)	Acceleration ( $\text{m/s}^2$ )
100	40	
	60	10
1000		25
	0.2	10
30	600	

4. Figure 3.57 shows the forces acting on three different objects. For each:
  - (a) calculate the resultant force acting;
  - (b) say whether the forces are balanced or unbalanced;
  - (c) calculate the object's acceleration.
5. Explain the differences between mass and weight.

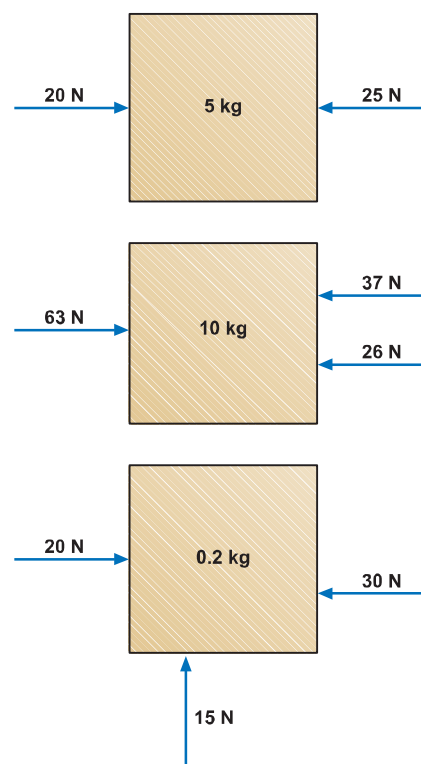
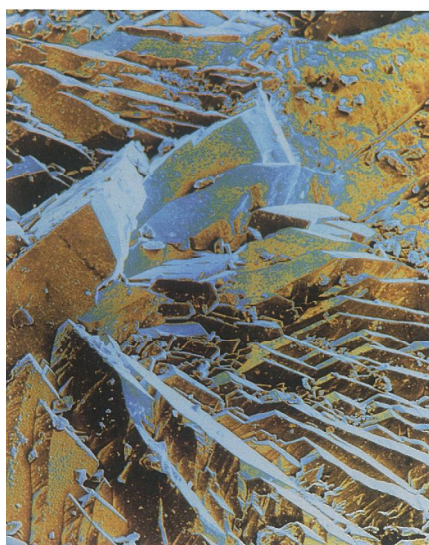


Figure 3.57 See Question 4

### 3.3 Frictional forces

By the end of this section you should be able to:

- Explain the causes of frictional forces.
- Describe the differences between limiting friction, static friction and kinetic friction.
- Draw free body diagrams for objects on inclined planes (to include frictional forces) and use these diagrams to solve problems.



**Figure 3.58** Even very smooth surfaces have a rough texture at the microscopic level.

#### KEY WORDS

**friction** the force generated when solids slide or attempt to slide over each other

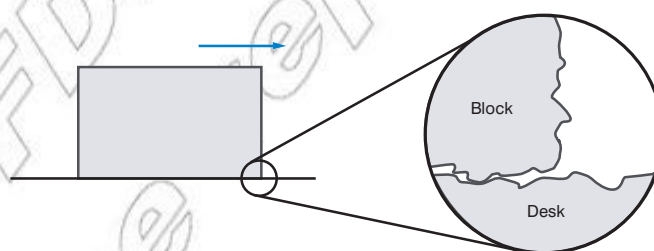


**Figure 3.60** Sandpaper is very rough. Sliding over sandpaper generates a great deal of friction.

#### What causes friction?

**Friction** is a force we experience every single day. Without friction even the simplest of actions, like walking, would be impossible. Friction occurs whenever two solids rub against each other. It is a contact force and it always tends to act in a direction opposing motion.

It is caused by tiny bumps in the surface of the two objects knocking and locking together. No surface is perfectly smooth. This is obvious if you look closely at sandpaper but you need to look really close at smoother objects like a metal sheet.



**Figure 3.59** The bumps on the surfaces of material knock together causing friction.

When magnified, you can see all the small bumps in the surface of a material. It is these bumps that cause friction.

#### Different types of friction

There are two different types of friction. It depends on if the objects in contact are moving or if they are stationary.

##### Static friction

- **This is the frictional force between two objects that are in contact and trying to move past each other, but not yet moving.**

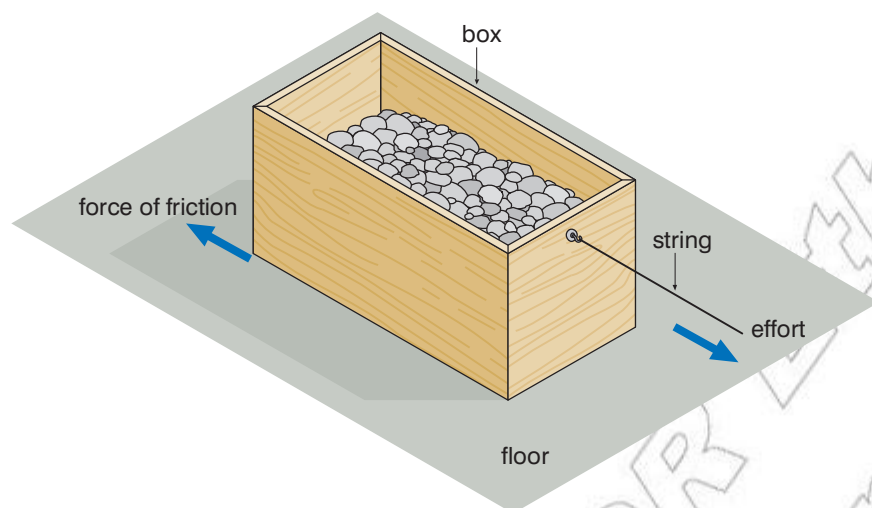
Imagine gently pushing a heavy book on a desk. At first it does not accelerate. This is because the force you are applying is cancelled out due to static friction. As you gradually increase the force the static friction also increases and the book remains stationary. If

you continue to push harder, eventually the book will slide. The maximum value of the static friction, i.e. the value just before sliding occurs, is called the **limiting friction**.

### Kinetic friction (sometimes called dynamic friction)

- This is the frictional force between two objects sliding over each other.

It always acts in the opposite direction to motion.



**Figure 3.61** Kinetic friction always acts in the opposite direction to motion.

The force of friction usually drops when objects start moving and so it is often the case that kinetic friction is less than the limiting friction of a surface.

### Factors affecting the frictional force

There are several factors affecting the force of friction between objects.

Perhaps the most obvious is the **roughness** of the surface. The rougher the surface, the greater the friction. In simple terms the bumps on the surface are bigger or more frequent. This causes them to lock together more easily or more often.

You might think the weight of the object affects the friction. A heavier object will push down harder on the surface locking the bumps together harder and so increasing the force of friction. This is generally true but actually it is the contact force that affects the friction. Think about the lift example covered in the previous section. When the lift is accelerating downwards the weight stays the same but the contact force (and so the frictional force) would drop. This is especially important when considering objects on slopes (more on this later).

### Think about this...

Friction only happens when solids rub together. This means that there is no such thing as friction with the air or friction through water; both of these examples are types of drag. This is a different type of force.



**Figure 3.62** The friction between snow and ski is very small. This allows professional skiers to reach some very high speeds.

### KEY WORDS

**kinetic friction** the frictional force between two objects sliding over each other

**limiting friction** the maximum value of static friction

**static friction** the frictional force between two objects that are trying to move against each other but are not yet moving

**roughness** a measure of the texture of a surface

**DID YOU KNOW?**

Friction is really just another example of the electrostatic force. It is caused by the electrons in the atoms in the bumps repelling each other.

**Think about this...**

The surface area of the objects in contact with each other does not affect the frictional force between them. Although there is a greater area in contact, the weight of the object is more spread out and so there is no change in the frictional force.

**KEY WORDS**

**coefficient of friction** *a ratio representing the friction between two surfaces*

The friction force between objects can be calculated using the following equation:

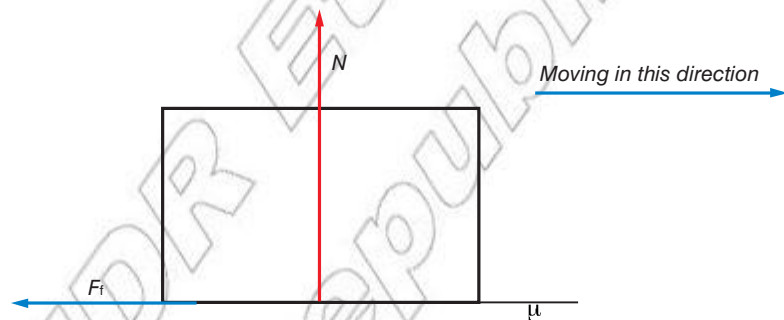
$$F_f = \mu N$$

where:

$F_f$  is the frictional force.

$\mu$  is a constant called the **coefficient of friction**, which depends on the roughness of the two surfaces. A high coefficient of friction would mean that the surfaces are very rough and so this would lead to a high frictional force. Materials have a static coefficient of friction and a kinetic coefficient of friction, depending on the type of friction being calculated.

$N$  is the normal contact force acting on the block. Normal in this case means at right angles to the surface. If the block is horizontal and there is no vertical acceleration then the normal contact force is equal to the weight.



**Figure 3.63** Factors affecting friction

**Table 3.5** Examples of the static friction coefficient between materials

Materials rubbing together		$\mu_{static}$
Aluminium	Steel	0.61
Concrete	Rubber	1.00
Concrete	Wood	0.62
Steel	Teflon	0.04
Wood	Wood	0.45

**Worked example**

The kinetic coefficient of friction between rubber and asphalt is 0.8. Calculate the force of friction acting on a rubber block of mass 2.0 kg as it is pulled along a level road at a steady speed.

$$F_f = \mu_{kinetic} N \quad \text{State principle or equation to be used}$$

$$F_f = 0.8 \times N \quad \text{Substitute in known value for } \mu_{kinetic}$$

As the road is level the normal contact force is equal to the weight of the rubber block. In this case the weight = 20 N (2 kg × 10 N/kg)

$$F_f = 0.8 \times 20 \text{ N} \quad \textit{Substitute in known values and complete calculation}$$

$$F_f = 16 \text{ N} \quad \textit{Clearly state the answer with unit}$$

A 12 kg block of wood is stationary on a horizontal concrete slab. The maximum coefficient of static friction between wood and concrete is 0.65 (this occurs at the limiting friction). What force needs to be applied in order to slide the block along.

$$F_f = \mu_{\text{static}} N \quad \textit{State principle or equation to be used}$$

$$F_f = 0.65 \times N \quad \textit{Substitute in known constant for } \mu_{\text{static}}$$

As the block is level the normal contact force is equal to the weight of the wood. In this case the weight = 120 N

$$F_f = 0.65 \times 120 \text{ N} \quad \textit{Substitute in known values and complete calculation}$$

$$F_f = 78 \text{ N} \quad \textit{Clearly state the answer with unit}$$

### DID YOU KNOW?

Teflon has one of the lowest coefficients of friction of any material. It was accidentally invented by an American named Roy Plunkett in 1938. The use of Teflon was important in America's development of the atomic bomb. Nowadays its low friction makes it ideal for non-stick frying pans!

### Activity 3.4: Measuring friction

- Tie a block of wood with string to the hook of a spring balance. Place the block on a table. Pull the balance gradually parallel to the table. Note its reading when the block just starts to move.

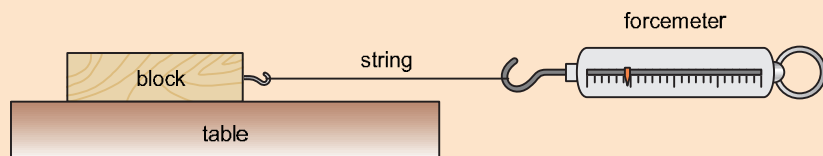
- Repeat and take the average of the results.

You have measured the maximum force of static friction (the limiting friction).

- Now pull the balance until the block moves steadily along. Note the reading.
- Repeat several times and take the average.

You have measured the force of dynamic friction.

- Which is greater?



**Figure 3.65** Measuring friction using a spring balance

You must ensure you pull the block along at a steady speed. This tells us the forces are balanced and the reading on the spring balance is the same as the frictional force.



**Figure 3.64** Non-stick frying pans have a very low friction coefficient.

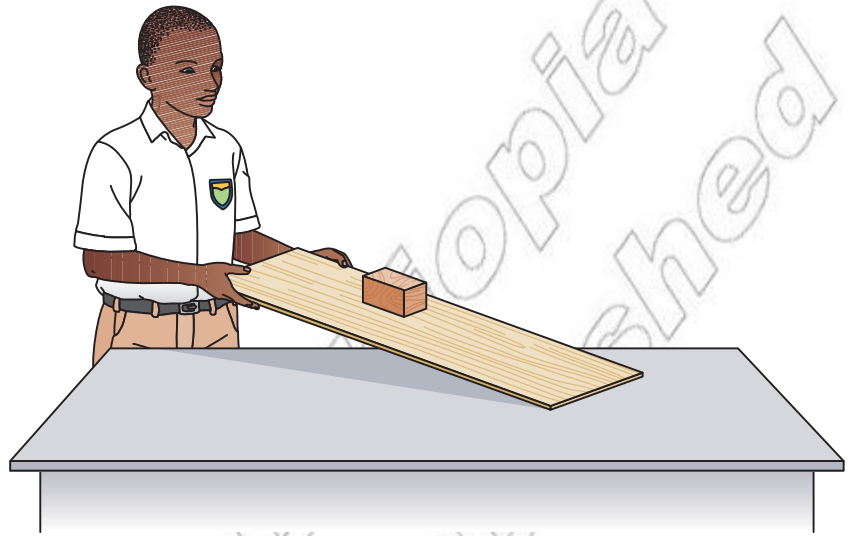


**KEY WORDS**

**inclined plane** *a sloping surface or ramp*

**Friction and inclined planes**

If an object is resting on an **inclined plane** the normal contact force is reduced (the weight stays the same). This means the frictional force is also reduced.



**Figure 3.66** A wooden block on a slope

Let's assume the block is not sliding down the ramp. If we consider the forces acting on the object we can see that there are three different forces.

As the object is not accelerating (in this case it is stationary) we can conclude from Newton's first law that there is no resultant force acting.

These three forces must form a triangle, as shown in Figure 3.68.

The normal contact force is given by:

- $N = w \cos \theta$

This is always true regardless of if the object is in equilibrium or not. As a result, as the angle of the slope increases the normal contact force falls and so does the force due to friction. If the slope was vertical then the force due to friction would be 0 N.

In order for the block to remain stationary (i.e. the forces remain balanced) then the force due to static friction must equal:

- $F = w \sin \theta$

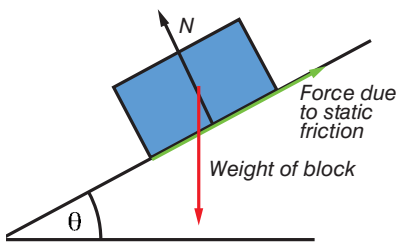
where  $w$  is the weight of the block,  $F$  is the force due to static friction and  $\theta$  is the angle of the slope.

However, the force of friction is also equal to:

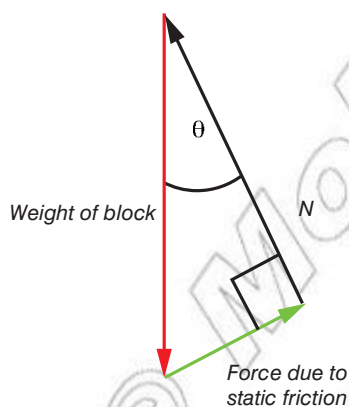
- $F_f = \mu_{static} N$

In this case  $N = w \cos \theta$ , so:

- $F_f = \mu_{static} w \cos \theta$



**Figure 3.67** Forces acting on a block on a slope



**Figure 3.68** The three forces form a triangle with no resultant force.

As the angle of the slope increases,  $\cos \theta$  gets smaller. This means the frictional force that can be provided also falls (as all the other variables are constant). At the same time the force required to keep the object stationary ( $w \sin \theta$ ) increases.

This means as the slope gets steeper eventually the block will accelerate down the slope as the forces can no longer be balanced; the limiting friction has been reached and exceeded.

If the object is accelerating down the slope then there must be a resultant force acting on the object.

This resultant force is equal to the difference between  $w \sin \theta$  and the force due to kinetic friction.

$$\bullet F_{net} = w \sin \theta - \mu_{kinetic} N$$

Take, for example, a block of wood of mass 30 kg accelerating down a concrete slope inclined at  $45^\circ$ . We could use the formula above to calculate the acceleration of the block. The  $\mu_{kinetic}$  between the wood and the slope is  $= 0.45$ .

First we need to find the resultant force:

$$\bullet F_{net} = w \sin \theta - \mu_{kinetic} N \text{ Express } F_{net} \text{ in terms of other forces}$$

In this case the weight of the block is 300 N (from  $w = mg$ ) and the normal contact force is 212 N (from  $N = w \cos \theta$ ).

$$F_{net} = 300 \text{ N} \times \sin 45^\circ - (0.45 \times 212 \text{ N}) \text{ Substitute in known values and complete calculation}$$

$$F_{net} = 117 \text{ N} \text{ Clearly state the answer with unit}$$

The acceleration of the block can then be calculated using Newton's second law.

$$F_{net} = ma \text{ State principle or equation to be used (Newton's second law)}$$

$$a = F_{net} / m \text{ Rearrange equation to make } a \text{ the subject}$$

$$a = 117 \text{ N} / 30 \text{ kg} \text{ Substitute in known values and complete calculation}$$

$$a = 3.3 \text{ m/s}^2 \text{ Clearly state the answer with unit}$$

### Think about this...

Putting the two equations for the friction force equal to each other:  $w \sin \theta = \mu_{static} w \cos \theta$ . This can be rewritten as  $\tan \theta = \mu_{static}$  and so the maximum angle of the slope before the block will slide is given by  $\theta = \tan^{-1} \mu_{static}$ . The higher the maximum value for  $\mu_{static}$  the steeper the slope can be before the object slides down the slope.

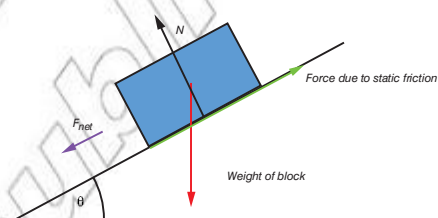


Figure 3.69 The object slides due to a resultant force.

## Reducing friction

In order to reduce the friction between objects there are two techniques that can be used.

### Polishing

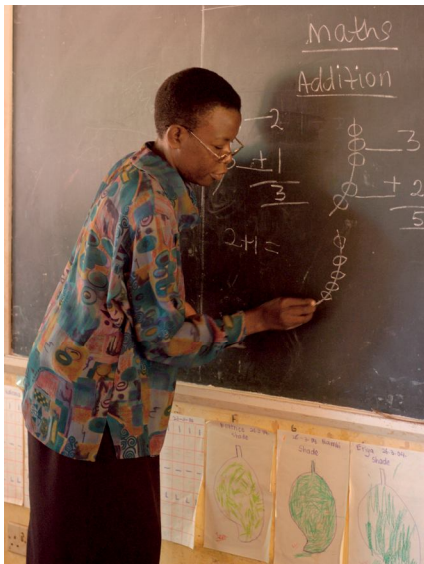
Polishing or sanding down an object reduces the size of the bumps on the surface. This makes it smoother and so the coefficient of friction drops.



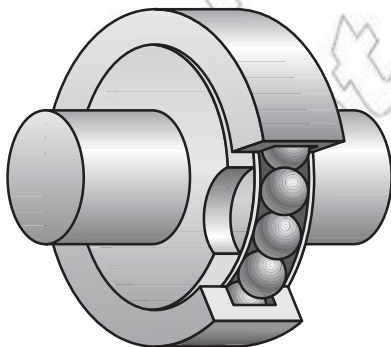
Figure 3.70 Polishing reduces the roughness of a surface.



**Figure 3.72** Without oil vehicle engines would heat up too much and possibly seize up entirely.



**Figure 3.73** Friction between board and chalk causes the chalk to gradually wear away

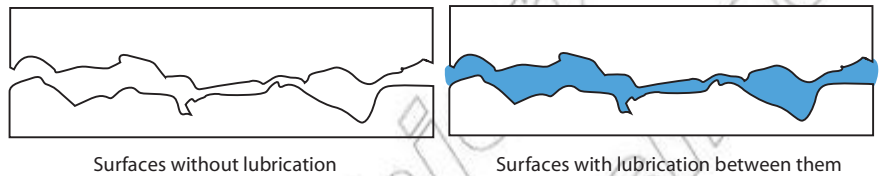


**Figure 3.74** Ball bearings ensure that a wheel turns smoothly on its axle.

### Lubrication

Lubricating between the surfaces rubbing together also reduces friction. Commonly used lubricants include oil, water and even graphite.

The lubricant effectively fills the gaps between the materials, preventing them from bumping into each other and so allowing them to slide over each other easily.



**Figure 3.71** Lubrication keeps the surfaces apart.

### The effects of friction

Friction causes a heating effect. When you rub your hands together friction between them causes them to warm up. This has many applications but also causes several problems.

#### Advantages of friction

Is friction always a problem? No. We could not walk if there was no friction. Our feet would slip, just as they do on ice, banana skin or very smooth surfaces. Rubber-soled shoes and car tyres have 'tread' on them to increase friction. Smooth tyres tend to skid, especially on wet, greasy or icy roads.

The brakes on a bicycle, car or other vehicle make use of friction. The brake pads press on the wheels, slowing them down.

Figure 3.73 shows one situation where friction is useful. Without friction, the teacher's chalk would not mark the board.

#### Disadvantages of friction

When two parts of any machine rub against each other, the friction between them causes heat, noise and wear. The heat produced in fast-moving machines may be so great that the parts become red-hot.

Friction is reduced by lubrication with grease, oil or graphite. Bicycles and sewing machines need oil regularly. The engine of a motor car has a case at the bottom, called a sump, which is full of oil. This covers all the moving parts in the engine. If the engine has too little oil, the pistons and cylinders become so hot that they join together.

A bicycle wheel must turn freely. If there is friction between the wheel and its axle, the bicycle will be harder to ride. Ball bearings between the wheel and axle allow the wheel to turn freely – see Figure 3.74.

## Summary

In this section you have learnt that:

- Friction is a force generated when solids either attempt to slide or slide over each other.
- Friction is caused by bumps in the surface of the materials.
- Static friction occurs when objects try to move past each other. Kinetic friction occurs when objects slide over each other; it acts in the opposite direction to motion.
- Frictional forces can be calculated using  $F = \mu N$  (where  $N$  is the normal contact force – this reduces if the object is on an inclined plane).

## Review questions

1. Describe the causes of friction and the factors that affect it.
2. Explain the difference between static friction and kinetic friction.
3. If the static friction between wood and concrete is 0,62, determine the force required to make a wooden block of mass 2 kg start to slide.
4. Give two examples in which friction is useful and two where it is a disadvantage.

## 3.4 Newton's third law

By the end of this section you should be able to:

- State Newton's third law.
- Describe experiments to demonstrate it and give examples of where it is applicable.

### The third law of motion

Newton's third law deals with what happens when you apply a force. It is perhaps the most counter-intuitive of Newton's three laws. It states:

- **If body A exerts a force on body B then body B will exert an equal and opposite force on body A.**

In simple terms this means whenever you push an object it pushes back with an equal and opposite force; essentially forces come in pairs. You can't apply a force to an object without that object applying the same force back onto you.

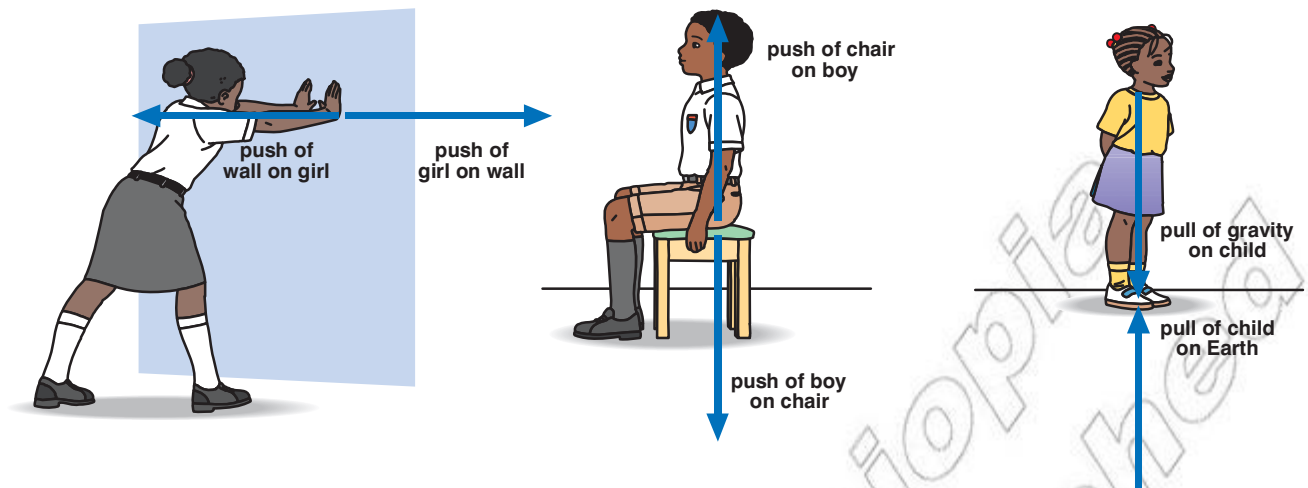


Figure 3.75 Examples of Newton's third law in action.

The pairs of forces are often called a **Newton's pair** or an action and reaction pair. It is important to notice that they are equal and opposite.

- **Equal:** same magnitude
- **Opposite:** opposite direction

If you push **down** on the desk with a force of **10 N** the desk pushes back **up** with a force of **10 N**. This applies to all forces!

It may seem strange but the gravitational attraction of the Earth on a satellite is exactly the same size as the pull on the Earth from the satellite. The same is true at ground level. If you hold a stone above the Earth then it pulls the Earth up with the same force that the Earth pulls the stone down. When you drop it the stone appears to fall but both the stone and the Earth experience the same force. However, the stone's acceleration is much, much greater as it has much less mass.

To correctly identify Newton's pairs it is worth remembering that the pairs of forces must fit the following four criteria:

- **equal in magnitude**
- **opposite direction**
- **act on different bodies**
- **same type of force**

So, for example, consider a book on a desk.

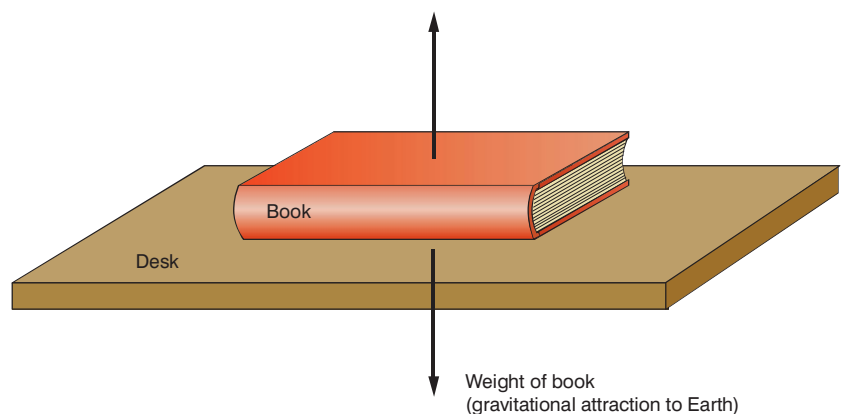


Figure 3.77 Two forces acting on a book, but they are not a Newton pair.

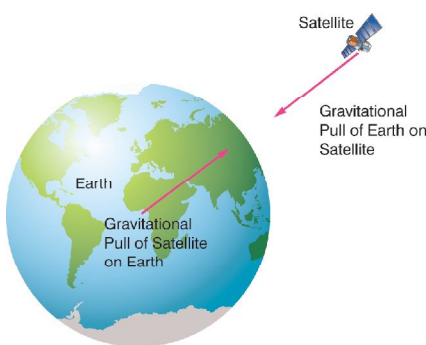


Figure 3.76 An example of Newton's pairs

**KEY WORDS**

**Newton's pair** a pair of equal and opposite forces acting between two objects

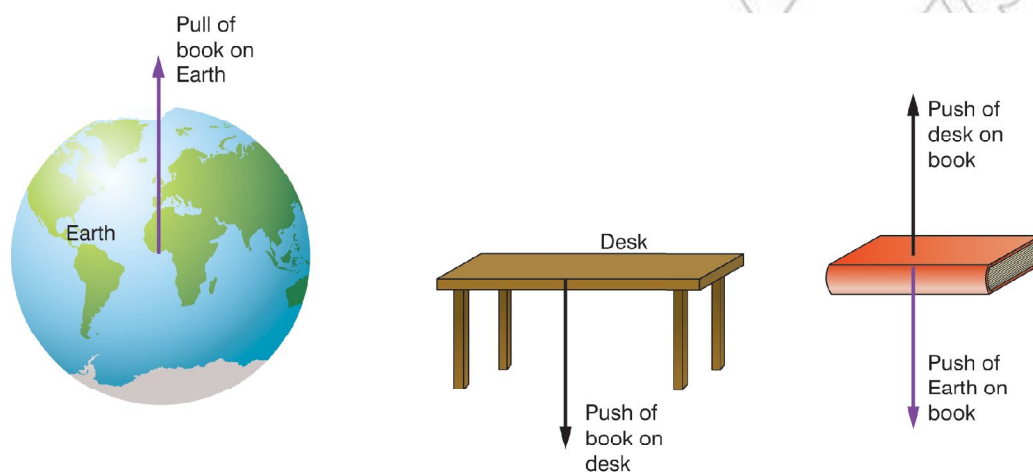
Figure 3.77 shows two forces acting on the book, but they are not an action–reaction pair. They are equal and opposite but they do not act on different bodies and they are not the same type of force.

So, where are the Newton's pairs in this example?

**Table 3.6** Newton's pairs for a book on a desk

Force	Newton's pair
Contact force on book from desk	Contact force on desk from book
Weight of book (gravitational attraction of the Earth pulling on the book)	Gravitational attraction of the book pulling on the Earth

The book pushes down on the desk and pulls the Earth upward due to gravitational attraction. These are the pairs to the two forces in Figure 3.77. If we draw three free body diagrams (Figure 3.78) we can more easily see the pairs of forces.



**Figure 3.78** The two pairs of forces

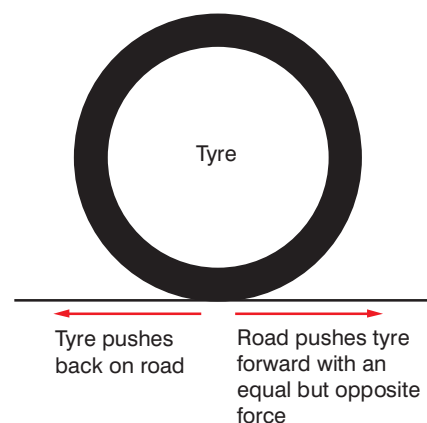
There are two more pairs of forces not included in Figure 3.78. Can you work out what they are? (Hint: they do not involve the book).

### Applications of the third law

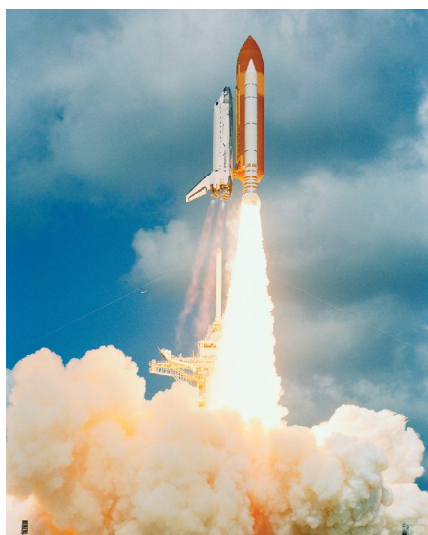
Newton's third law is incredibly important to motion. Applications such as rockets, jet engines, cars and even just walking around rely on this law.

When you walk you push backwards on the ground; at the same time the ground pushes forward on you and so you accelerate forwards! The same is true with car tyres.

With a rocket or jet engine hot gases are blasted out of the back; they are in essence pushed out. This results in an equal and opposite force on the engine pushing it forward.



**Figure 3.79** Newton's third law in action



**Figure 3.80** Without Newton's third law space rockets would not be able to move!

### Activity 3.5: Discovering equal and opposite forces

With a partner get a rope and two skateboards. Both stand on a board some distance apart and hold a rope between you. If one of you holds the rope and the other one pulls it towards them, who moves?

You both will! An equal and opposite force is exerted on the puller. If he pulls with twice as much force he will experience twice as much force pulling him forwards.

### Summary

In this section you have learnt that:

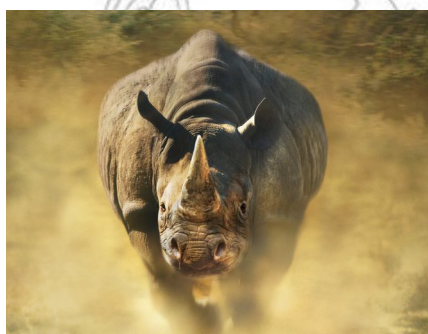
- Newton's third law states: "If body A exerts a force on body B then body B will exert an equal and opposite force on body A".
- Newton's third law means forces always come in pairs.

### Review questions

1. State Newton's third law.
2. Describe the characteristics of Newton's pairs of forces and give three different examples.

### DID YOU KNOW?

As well as linear momentum there is another physical property called **angular momentum**. This is all to do with the rotation of a spinning object. For the purpose of the following sections any reference to momentum refers to linear momentum.



**Figure 3.81** A charging rhino has a large momentum!

### 3.5 Conservation of linear momentum

By the end of this section you should be able to:

- Define linear momentum and state its units.
- State the law of conservation of momentum.
- Define the term impulse and state its units.
- Solve numerical problems relating to momentum, conservation of momentum and impulse.
- State Newton's second law in terms of momentum.

### What is linear momentum?

**Linear momentum** is another important idea in physics. It can be thought of as a measure of how hard it is to stop a moving object; the 'unstoppability' of the object. Objects with a larger linear momentum are harder to stop!

There are two factors that make an object hard to stop, its **mass** and its **velocity**. The greater the mass the harder it is to stop, the faster an object is moving the harder it is to stop. Linear momentum is

defined as the product of an object's mass and velocity. This leads to the equation for linear momentum:

- **linear momentum = mass × velocity**

Or in symbols:

- $p = mv$

$p$  is the symbol for linear momentum and as the units of mass are kg and the units of velocity are m/s it follows the units of linear momentum are kg m/s.

For example, a rhino running at top speed has quite a large momentum; it's very hard to stop! An adult black rhino may have a mass of 1000 kg and for short periods of time can reach 15 m/s when sprinting. To find its momentum we would use the equation:

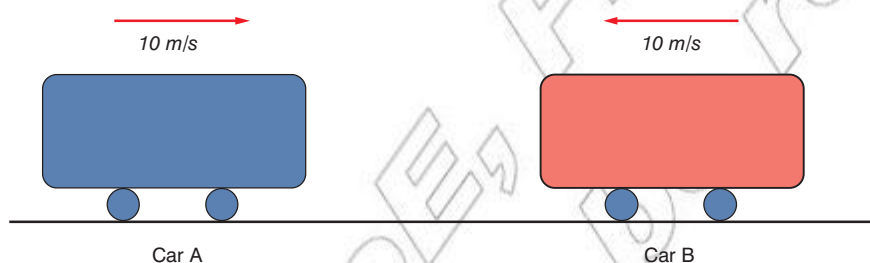
momentum = mass × velocity *State principle or equation to be used (definition of momentum)*

$p = 1000 \text{ kg} \times 15 \text{ m/s}$  *Substitute in known values and complete calculation*

$p = 15\,000 \text{ kg m/s}$  *Clearly state the answer with unit*

A sprinting human may have a momentum of around 640 kg m/s (assuming a velocity of 8 m/s and a mass of 80 kg).

Momentum is a **vector** quantity. This means the direction of motion of the object is really important. For example, take a situation where two identical cars are heading towards each other.



**Figure 3.83** Two head-on cars

The momentum of car A is:

momentum<sub>A</sub> = mass<sub>A</sub> × velocity<sub>A</sub> *State principle or equation to be used (definition of momentum applied to car A)*

$p_A = 1200 \text{ kg} \times 10 \text{ m/s}$  *Substitute in known values and complete calculation*

$p_A = 12\,000 \text{ kg m/s}$  to the right *Clearly state the answer with unit*

The momentum of car B is:

momentum<sub>B</sub> = mass<sub>B</sub> × velocity<sub>B</sub> *State principle or equation to be used (definition of momentum applied to car B)*

$p_B = 1200 \text{ kg} \times 10 \text{ m/s}$  *Substitute in known values and complete calculation*

$p_B = 12\,000 \text{ kg m/s}$  to the left *Clearly state the answer with unit*

### KEY WORDS

**angular momentum** *the momentum of an object moving in a circle*

**linear momentum** *a measure of how hard it is to stop a moving object*

**law of conservation of linear momentum** *law stating that in a closed system, the total linear momentum will remain constant*



**Figure 3.82** Due to its large mass a moving train has a large momentum.

### Think about this...

The equation for momentum shows that both the mass and velocity of an object are directly proportional to its momentum. This means an object with twice the mass travelling at the same speed will have double the momentum. Alternatively, an object going twice as fast will have double the momentum.



This could be written as:

$$p_B = -12\,000 \text{ kg m/s.}$$

This is really important because if you consider the cars together as one system then the total momentum is 0 kg m/s (not 24 000 kg m/s).

### DID YOU KNOW?

There are several conservation laws in physics. They include conservation of energy, conservation of linear momentum, conservation of angular momentum and conservation of electric charge. They form the basis of modern physics and always apply!

### The law of conservation of linear momentum

One of the most important conservation laws in physics is the **law of conservation of linear momentum**. It states:

- **In a closed system the total linear momentum must remain constant.**

This means that when objects collide the total linear momentum before the collision must equal the total linear momentum after the collision *as long as no external forces act on the system*. In symbolic terms this may be written as:

- $\Sigma p_{\text{initial}} = \Sigma p_{\text{final}}$

$\Sigma$  means 'sum of'.

Take, for example, a ball of mass 2.0 kg travelling at 5 m/s towards a ball of mass 1 kg.



**Figure 3.84** Two balls about to collide

The momentum before the collision must equal the momentum of ball A plus the momentum of ball B. Ball B is not moving so it has a momentum of 0 kg m/s.

$$\text{momentum}_A = \text{mass}_A \times \text{velocity}_A \quad \textit{State principle or equation to be used (definition of momentum)}$$

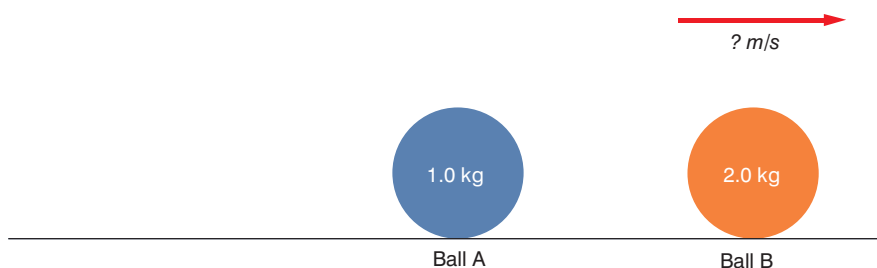
$$p_A = 1.0 \text{ kg} \times 5 \text{ m/s} \quad \textit{Substitute in known values and complete calculation}$$

$$p_A = 5 \text{ kg m/s to the right} \quad \textit{Clearly state the answer with unit}$$

This is the total momentum before the collision. The law of conservation of momentum states the momentum after the collision must also equal 5 kg m/s to the right.

This gives us several possible outcomes.

**Outcome 1:** Ball A stops and ball B moves away with a certain velocity.



**Figure 3.85** Ball B moves away from ball A

We can work out the velocity of ball B. As the total momentum of the system must equal 5 kg m/s then the momentum of ball B must be 5 kg m/s.

momentum<sub>B</sub> = mass<sub>B</sub> × velocity<sub>B</sub> *State principle or equation to be used (definition of momentum)*

velocity<sub>B</sub> = momentum<sub>B</sub> / mass<sub>B</sub> *Rearrange equation to make velocity<sub>B</sub> the subject*

$v_B = 5 \text{ kg m/s} / 2.0 \text{ kg}$  *Substitute in known values and complete calculation*

$v_B = 2.5 \text{ m/s}$  to the right *Clearly state the answer with unit*

Thinking about this answer it makes sense. Ball B has twice the mass of ball A and so the velocity will need to be half of that of ball A before they collided.

**Outcome 2:** The balls stick together (imagine there are magnets inside them) and they move away together with a certain velocity.



**Figure 3.86** The balls stick together

We can work out the velocity of the balls when they stick together. Just like the previous example the total momentum of the system must equal 5 kg m/s then the momentum of the balls must be 5 kg m/s.

momentum = mass × velocity *State principle or equation to be used (definition of momentum)*

velocity = momentum / mass *Rearrange equation to make velocity the subject*

$v = 5 \text{ kg m/s} / 3.0 \text{ kg}$  *Substitute in known values and complete calculation*

Notice we had to use a mass of 3.0 kg as this is the total mass of the two balls.

- $v = 1.7 \text{ m/s}$  to the right *Clearly state the answer with unit*

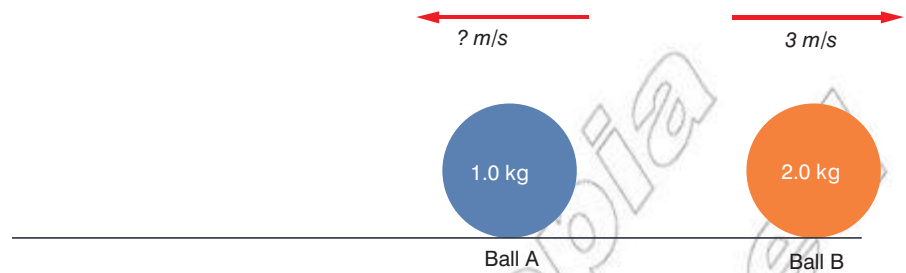
### Think about this...

If the mass of the system remains constant we can rewrite the equation as  $F_{net} = m\Delta v / \Delta t$ . Only velocity is changing as the mass is constant. From Unit 2 we know that  $\Delta v / \Delta t$  is the acceleration of the object. As a result we get  $F_{net} = ma$  but only if the mass is constant!

### Think about this...

If the object changes direction then you mustn't forget momentum is a vector quantity. A ball going from a momentum of 10 kg m/s to the left to 5 kg m/s to the right has experienced a change of momentum of 15 kg m/s to the right.

**Outcome 3:** Ball A bounces back off ball B. Ball B moves to the right with a velocity of 3 m/s and ball A moves back in opposite direction.



**Figure 3.87** Ball A bounces off ball B and both balls move

Again, just like the previous example the total momentum of the system must equal 5 kg m/s. However, this time both the balls have a momentum. The momentum of ball B is given by:

$$\text{momentum}_B = \text{mass}_B \times \text{velocity}_B \quad \textit{State principle or equation to be used (definition of momentum)}$$

$$p_B = 2.0 \text{ kg} \times 3 \text{ m/s} \quad \textit{Substitute in known values and complete calculation}$$

$$p_B = 6 \text{ kg m/s to the right} \quad \textit{Clearly state the answer with unit}$$

In order for momentum to be conserved ball A must have a momentum of  $-1 \text{ kg m/s}$  or a momentum of  $1 \text{ kg m/s}$  to the left. This will give us a total momentum of  $5 \text{ kg m/s}$  to the right.

The velocity of ball A can then be calculated.

$$\text{momentum}_A = \text{mass}_A \times \text{velocity}_A \quad \textit{State principle or equation to be used (definition of momentum)}$$

$$\text{velocity}_A = \text{momentum}_A / \text{mass}_A \quad \textit{Rearrange equation to make velocity}_A \textit{ the subject}$$

$$v_A = -1 \text{ kg m/s} / 1.0 \text{ kg} \quad \textit{Substitute in known values and complete calculation}$$

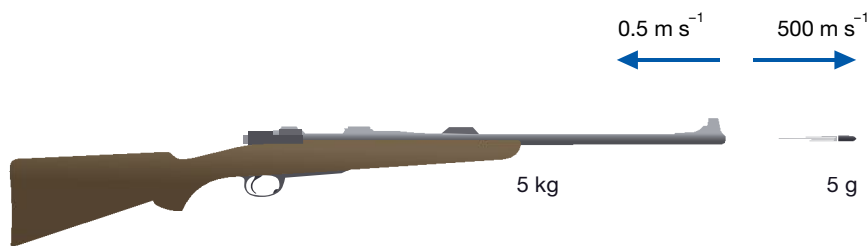
$$v_A = -1 \text{ m/s or } 1 \text{ m/s to the left} \quad \textit{Clearly state the answer with unit}$$

There are several other possible outcomes depending on the masses of the objects and the materials they are made out of. **In every possible case the linear momentum of the system must be conserved!**

## Explosions

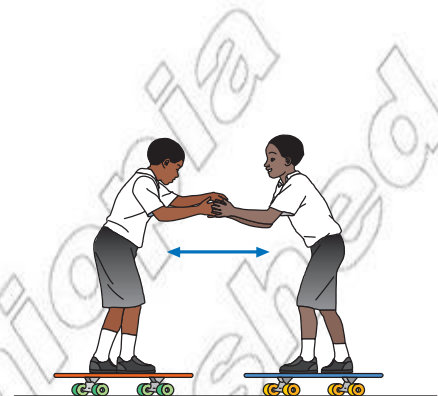
When a gun is fired, an explosion occurs inside the gun and the bullet flies off at high speed. The person firing the gun has to be ready for the recoil – the gun pushes back against their shoulder, in the opposite direction to the direction of the bullet. Figure 3.88 shows why this is.

- The bullet has a small mass and a high velocity, towards the right.
- The gun has a larger mass and a smaller velocity, towards the left.



**Figure 3.88** The momentum of the bullet is equal and opposite to the momentum of the gun

Before the explosion, neither the gun nor the bullet had any momentum. In the explosion, the bullet is given momentum to the right, while the gun is given an equal amount of momentum to the left. Recall that momentum is a vector quantity; equal and opposite amounts of momentum cancel out, so the total amount of momentum after the explosion is zero. Hence there is just as much momentum after the explosion as there was before it, so we can again see that momentum has been conserved.



**Figure 3.89** An explosive situation

### Back to Newton's second law

Earlier we discussed Newton's second law as:

- **The acceleration of an object is directly proportional to the resultant force acting on the object.**

and

- **This acceleration occurs in the direction of the resultant force.**

However, this only applies if the mass of the system remains constant. Newton's original concept for the second law involved forces changing the linear momentum of objects.

He said:

- **The resultant force acting on an object must be directly proportional to the rate of change of linear momentum of the object.**

and

- **The change in linear momentum occurs in the same direction as the resultant force.**

Using symbols this becomes:

$$\bullet F_{net} = \Delta^{mv} / \Delta t$$

(Remember the  $\Delta$  means 'change in'.)

To recap, the law of conservation of linear momentum states that the momentum must remain constant unless an external force acts. What Newton's second law tells us is that the momentum of a system can change if a force acts on it. The two compliment each other!

### Activity 3.6: The human explosion

- Find two students with the same mass. Make them stand on platforms with wheels, facing each other (Figure 3.89).
- One student pushes the other gently, in an attempt to make him or her move away. (This is a simple way of making an 'explosion' in the lab.) What happens?
- Does it make any difference which student does the pushing, or if both push?
- Try again with students having different masses.

## KEY WORDS

**impulse** *the magnitude of a force multiplied by the time for which it acts*

## Worked example

A car of mass 1400 kg accelerates from 10 m/s to 15 m/s over 3.5 s. Find the average resultant force acting.

$$F_{net} = \Delta mv / \Delta t \quad \text{State principle or equation to be used (Newton's second law in terms of momentum)}$$

The change in momentum is equal to the final momentum minus the initial momentum.

$$\Delta mv = mv - mu \quad \text{Express simple statement of change in momentum}$$

$$\Delta mv = (1400 \text{ kg} \times 15 \text{ m/s}) - (1400 \text{ kg} \times 10 \text{ m/s}) \quad \text{Substitute in known values and complete calculation}$$

$$\Delta mv = 7000 \text{ kg m/s} \quad \text{Clearly state the answer with unit}$$

$$F_{net} = \Delta mv / \Delta t \quad \text{State principle or equation to be used (Newton's second law in terms of momentum)}$$

$$F_{net} = 7000 \text{ kg m/s} / 3.5 \text{ s} \quad \text{Substitute in known values and complete calculation}$$

$$F_{net} = 2000 \text{ N, in the direction of its acceleration} \quad \text{Clearly state the answer with unit}$$

(As the mass of this system can be assumed to be constant we could have used  $F_{net} = ma$ ).

## Worked example

Imagine gently hitting a tennis ball of mass 100 g with a force of 50 N. The tennis racket and ball are in contact for just 0.02 s. We can calculate the change in momentum.

$$F_{net} = \Delta mv / \Delta t \quad \text{State principle or equation to be used (Newton's second law in terms of momentum)}$$

$$\Delta mv = F_{net} \times \Delta t \quad \text{Rearrange equation to make } \Delta mv \text{ the subject}$$

$$\Delta mv = 50 \text{ N} \times 0.02 \text{ s} \quad \text{Substitute in known values and complete calculation}$$

$$\Delta mv = 1.0 \text{ kg m/s in the direction of the 50 N force} \quad \text{Clearly state the answer with unit}$$

## Acting on impulse

The **impulse** of a force is the magnitude of the force multiplied by the time which it acts.

- Impulse =  $F\Delta t$

The units of impulse are usually expressed as N s.

An impulse of 10 N s could be caused by a 10 N force acting for 1 s or a 1 N force acting for 10 s (and thousands of other combinations!).

From Newton's second law we get:

$$\bullet F_{net} = \Delta mv / \Delta t$$

This can be written as:

- $F_{net} \Delta t = \Delta mv = \text{impulse}$
- The impulse of a force is also equal to the change in momentum of the object.**

So, the longer the force acts on an object the greater the impulse and so the greater the change in momentum.

### Think about this...

In most sports participants are encouraged to follow through when kicking or hitting a ball. This increases the time the force is acting and so gives rise to a greater impulse and so a greater change in momentum.

### Worked example

A footballer kicks a stationary ball of mass 1 kg with a force of 90 N. The first time his foot is in contact with the ball for just 0.01 s. The second time he follows through and his foot is in contact with the ball for 0.1 s. Find the impulse, change in momentum and the velocity of the ball after impact in each case.

**Table 3.7** Calculating the velocity of footballs

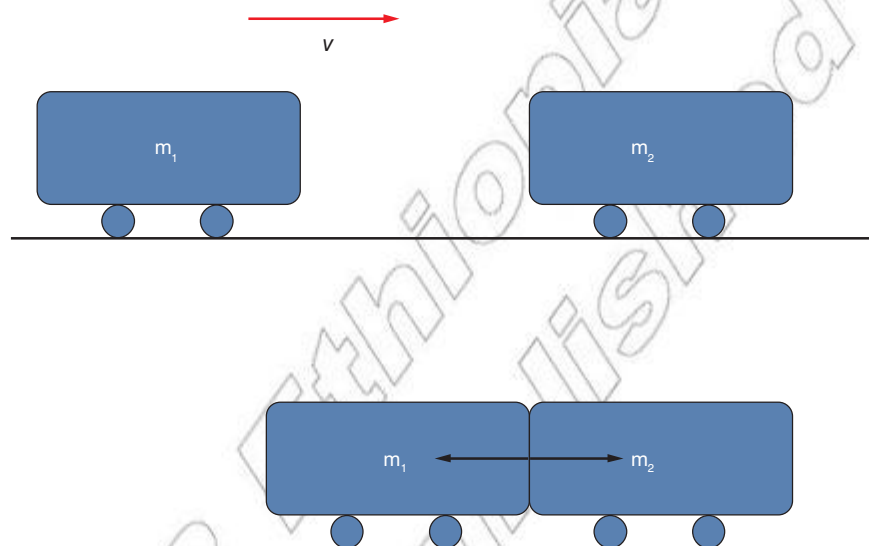
$\Delta t = 0.01 \text{ s}$	$\Delta t = 0.1 \text{ s}$
Impulse = $F\Delta t$	Impulse = $F\Delta t$
Impulse = $90 \text{ N} \times 0.01 \text{ s}$	Impulse = $90 \text{ N} \times 0.1 \text{ s}$
Impulse = $0.9 \text{ N s}$	Impulse = $9 \text{ N s}$
Change in momentum = impulse	Change in momentum = impulse
Change in momentum = $0.9 \text{ kg m/s}$	Change in momentum = $9 \text{ kg m/s}$
As the initial momentum was $0 \text{ kg m/s}$ the change in momentum must equal the final momentum of the ball.	As the initial momentum was $0 \text{ kg m/s}$ the change in momentum must equal the final momentum of the ball.
Final momentum = $0.9 \text{ kg m/s}$	Final momentum = $9 \text{ kg m/s}$
$p = mv$ so $v = p / m$	$p = mv$ so $v = p / m$
$v = 0.9 \text{ kg m/s} / 1 \text{ kg}$	$v = 9 \text{ kg m/s} / 1 \text{ kg}$
$v = 0.9 \text{ m/s}$	$v = 9 \text{ m/s}$

### Newton's laws and conservation of linear momentum

Using Newton's laws we can prove the law of conservation of linear momentum. Imagine two railway carriages. If one crashes into the other, they will exert equal and opposite forces on each other (Newton's third law). This force will be acting for the same time on

each carriage; therefore the impulse on each carriage will be the same ( $F\Delta t$ ).

Both carriages will experience the same force but in opposite directions. They will therefore have the same change in momentum, but in opposite directions (Newton's second law).



**Figure 3.90** Two railway carriages colliding

The change in momentum of each carriage is given by  $F\Delta t = \Delta mv$ . The first carriage will experience a change in momentum equal and opposite to the second carriage. Therefore:

- $m_1 \Delta v_1 = -m_2 \Delta v_2$

Or

- $0 = m_1 \Delta v_1 - m_2 \Delta v_2$

The total change of momentum of the system is 0 kg m/s; therefore the momentum has not changed and momentum has to be conserved!

### Summary

In this section you have learnt that:

- Linear momentum is defined as the product of an object's mass and velocity (as given by  $p = mv$ ). It is a vector quantity measured in kg m/s.
- The law of conservation of momentum states: "In a closed system the total linear momentum remains constant." This means if there are no external forces acting then the total momentum before a collision/explosion must be the same as the total momentum after the collision/explosion.
- The impulse of a force is defined as the force multiplied by the time the force is acting. It has units of N s. Impulse is equal to the change in momentum of an object.

- In terms of momentum, Newton's second law can be written as: "The resultant force acting on an object must be directly proportional to the rate of change of linear momentum of the object and the change in linear momentum occurs in the same direction as the resultant force." Using symbols this becomes:  $F_{net} = \Delta mv / \Delta t$

## Review questions

1. Define linear momentum and state its units.
2. Calculate the momentum of a car of mass 1200 kg travelling with a velocity of 30 m/s.
3. A car of mass 500 kg is moving at 24 m/s. A lion of mass 100 kg drops on to the roof of the car from an overhanging branch. Show that the car will slow down to 20 m/s.
4. A car of mass 600 kg is moving at a speed of 20 m/s. It collides with a stationary car of mass 900 kg. If the first car bounces back at 4 m/s, at what speed does the second car move after the collision?
5. A ball of mass 4 kg falls to the floor; it lands with a speed of 6 m/s. It bounces off with the same speed. Show that its momentum has changed by 48 kg m/s.

## KEY WORDS

**elastic collision** *collision between two objects where the total kinetic energy is conserved*

**inelastic collision** *collision between two objects where the total kinetic energy is less after the collision*

**kinetic energy** *the energy possessed by an object as a result of its motion*

## 3.6 Collisions

By the end of this section you should be able to:

- Distinguish between elastic and inelastic collisions.

**Elastic** and **inelastic** collisions will be covered in more detail in Unit 4. This short section serves as a brief introduction.

Whenever objects collide the linear momentum of the system must be conserved as long as there are no external forces acting. However, other quantities, such as **kinetic energy**, may change.

In a perfectly elastic collision the kinetic energy of the system before the collision must equal the kinetic energy of the system after the collision.

- **In an elastic collision the kinetic energy must be conserved.**

Perfectly elastic collisions are very rare. Snooker balls come pretty close but there is always a small drop in kinetic energy (most of this energy is transformed into heat and sound as the balls knock together).

A collision where the kinetic energy of the system drops after the collision is referred to as *inelastic*. Think of a tennis ball dropped on to the desk. It will bounce but it does not return to its original height as some of the kinetic energy has been lost.

Most collisions are inelastic but some are much more inelastic than others.



**Figure 3.91** Snooker balls produce near-perfect elastic collisions.



### Summary

In this section you have learnt that:

- Collisions can be classed as elastic or inelastic.
- In an elastic collision the kinetic energy of the system does not change.

### Review questions

1. Explain the difference between elastic and inelastic collisions.

### 3.7 The first condition of equilibrium

By the end of this section you should be able to:

- State the conditions required for linear equilibrium.
- Decide whether a system is in equilibrium.
- Apply the first condition of equilibrium to solve problems.

#### What is linear equilibrium?

**Equilibrium** was discussed briefly in Unit 1. In terms of forces, the first condition of linear equilibrium is when a body at rest or moving with uniform velocity has zero acceleration.

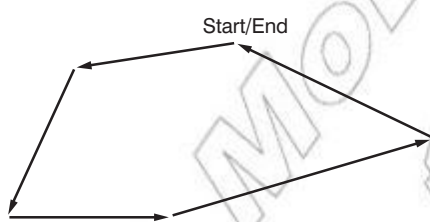
From Newton's first law, for this condition to be satisfied then the sum of all forces acting on it must be zero. In other words, there is no resultant force acting on the object.

Using the mathematical symbol  $\Sigma F$  for the sum of all forces we can write:

- **For linear equilibrium  $\Sigma F = 0$**

You must be careful when considering equilibrium. Free body diagrams often help here. Ensure that you have included all the forces acting on the object; don't forget weight and the contact forces acting on it.

If you draw a free body diagram and you end up back at the start then you can conclude there is no resultant force and the system is in equilibrium (remember if there are just three forces acting then they must form a triangle).



**Figure 3.92** Scale diagram showing no resultant force

### Worked example

Three forces are acting on a hovering helicopter. Its weight acts vertically downward and there is a strong horizontal wind. In order to hover, the force from the rotors must be directed slightly forward. Determine the magnitude of this force and its angle to the horizontal.

The helicopter is in equilibrium, therefore there is no net force acting on it. The three forces form a triangle, as shown in Figure 3.94.

To calculate the magnitude of the force we use Pythagoras's theorem:

$$a^2 = b^2 + c^2 \quad \text{State principle or equation to be used (Pythagoras's theorem)}$$

$$a^2 = (15\,000\text{ N})^2 + (3000\text{ N})^2 \quad \text{Substitute in known values and complete calculation}$$

$$a = 15\,300\text{ N} \quad \text{Clearly state the answer with unit}$$

To determine angle  $\theta$  we use trigonometry

$$\tan \theta = \text{opp} / \text{adj} \quad \text{State principle or equation to be used (trigonometry)}$$

$$\tan \theta = 15\,000 / 3000 \quad \text{Substitute in known values and complete calculation}$$

$$\tan \theta = 5 \quad \text{Solve for } \tan \theta$$

$$\theta = \tan^{-1} 5 \quad \text{Rearrange equation to make } \theta \text{ the subject and solve}$$

$$\theta = 79^\circ \quad \text{Clearly state the answer with unit}$$

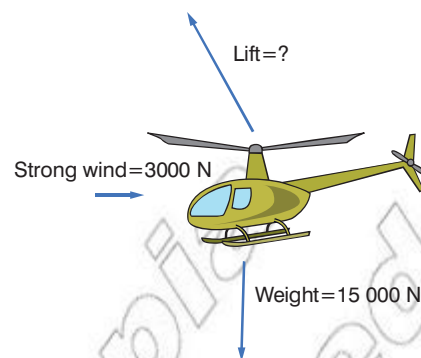


Figure 3.93 Three forces acting on a helicopter.

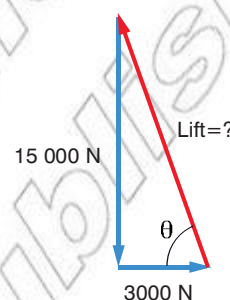


Figure 3.94 The forces on the helicopter form a triangle.

### Summary

In this section you have learnt that:

- A system/object is in linear equilibrium if there is no resultant force acting on it.

### Review questions

1. Explain what is meant by the term linear equilibrium and describe the conditions required.
2. Three forces are acting on an object in equilibrium, as shown in Figure 3.95. Either using a scale diagram or mathematically determine the magnitude and direction of force X.

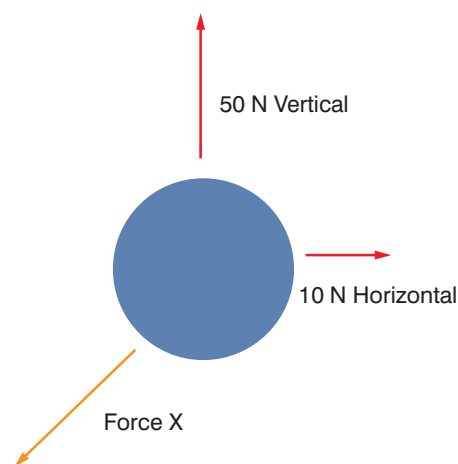


Figure 3.95 Can you find force X?

## End of unit questions

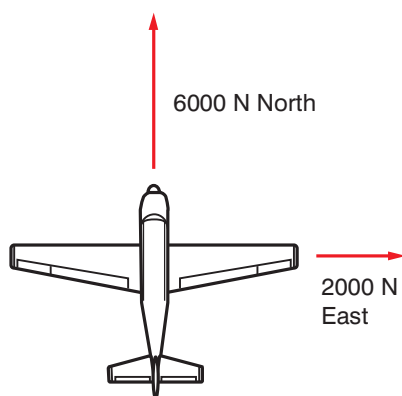


Figure 3.96 Forces acting on an aircraft

- State Newton's three laws of motion.
- Explain what is meant by the term inertia and describe how it is related to mass.
- A force of 10 N causes a spring to extend by 20 mm. Find:
  - the spring constant of the spring in N/m
  - the extension of the spring when 25 N is applied
  - the force applied that causes an extension of 5 mm.
- Calculate the weight of the following objects on Earth (assume  $g = 10 \text{ N/kg}$ ).
  - 12 kg
  - 500 g
  - 20 g
  - What is the mass and weight of each of the objects if they were placed on Mars? ( $g_{\text{Mars}} = 3.8 \text{ N/kg}$ )
- A runner of mass 60 kg accelerates at  $2.0 \text{ m/s}^2$  at the start of a race. Calculate the force provided from her legs.
- Two forces are acting on an aircraft of mass 2000 kg, as shown in Figure 3.96. Determine the acceleration of the aircraft.
- A concrete slab of mass 400 kg accelerates down a concrete slope inclined at  $35^\circ$ . The  $\mu_{\text{kinetic}}$  between the slab and slope is 0.60. Determine the acceleration of the block.
- State the law of conservation of linear momentum and describe its consequences.
- A bullet of mass 0.01 kg is fired into a sandbag of mass 0.49 kg hanging from a tree. The sandbag, with the bullet embedded into it, swings away at 10 m/s. Find:
  - the momentum after the collision
  - the momentum before the collision
  - the velocity of the bullet.
- A child of mass 40 kg jumps off a wall and hits the ground at 4 m/s. He bends his knees and stops in 1 s. Calculate the force required to slow him down. How would this force be different if he didn't bend his knees and stopped in 0.1 s?

Contents	
Section	Learning competencies
4.1 Mechanical work (page 88)	<ul style="list-style-type: none"> <li>Describe the necessary conditions for work to be done by a force (including work done by a force <math>F</math> acting on a body at an angle of <math>\theta</math>).</li> <li>Use <math>W = F s \cos \theta</math> to solve problems.</li> <li>Calculate the work done against gravity, the work done by a frictional force and the work done by a variable force.</li> <li>Distinguish between negative and positive work.</li> </ul>
4.2 Work–energy theorem (page 96)	<ul style="list-style-type: none"> <li>Explain the relationship between work and energy.</li> <li>Derive the relationship between work and kinetic energy and use this to solve problems.</li> <li>Show the relationship between work and potential energy as <math>W = -\Delta U</math> and use this to solve problems.</li> <li>Describe gravitational potential energy and elastic potential energy.</li> <li>Explain mechanical energy as the sum of kinetic and potential energy.</li> </ul>
4.3 Conservation of energy (page 101)	<ul style="list-style-type: none"> <li>State the law of conservation of mechanical energy.</li> <li>Revise the term collision and distinguish between elastic and inelastic collisions.</li> <li>Solve problems involving inelastic collisions in one dimension using the laws of conservation of mechanical energy and momentum.</li> <li>Explain the energy changes that take place in an oscillating pendulum and an oscillating spring–mass system.</li> <li>Describe the use of energy resources, including wind energy, solar energy and geothermal energy.</li> <li>Explain the meaning of the term renewable energy.</li> </ul>
4.4 Mechanical power (page 110)	<ul style="list-style-type: none"> <li>Solve problems relating to the definition of power.</li> <li>Show that the kWh is also a unit of work.</li> <li>Express the formula of mechanical power in terms of average velocity.</li> </ul>

Bouncing a ball involves some complex energy changes and transfers. No matter what surface you drop the ball on to, it will never return to its original height. Why is this? In simple terms, some of the ball's energy has been transferred into the air and ground. After the bounce it has less energy than it did before, and so it can't return to its original height.

This unit looks at work and energy, how it comes in different forms, and how you can transform it and transfer it. However, no matter how hard we try, we can't make any more energy than there is to start with, nor can we destroy any.



**Figure 4.1** These fishermen are working hard, but what does the term working hard mean?

### DID YOU KNOW?

The term work was first used in the 1830s by the French mathematician Gaspard-Gustave Coriolis. He is more famous for giving his name to the Coriolis effect. This explains the rotation of large weather systems like hurricanes and cyclones.



**Figure 4.2** The forklift is transferring energy to the box as it lifts it up. It is doing work.

With dwindling global energy resources and continuously increasing demand, energy issues will play a very significant role in the next 20 years.

## 4.1 Mechanical work

By the end of this section you should be able to:

- Describe the necessary conditions for work to be done by a force (including work done by a force  $F$  acting on a body at an angle of  $\theta$ ).
- Use  $W = F s \cos \theta$  to solve problems.
- Calculate the work done against gravity, the work done by a frictional force and the work done by a variable force.
- Distinguish between negative and positive work.

### What is work?

The term **work** is used all the time in everyday language. You might go to work, a device may stop working, you might complete schoolwork, or work hard to solve a problem. However, in physics, work means something very specific.

You might describe someone performing a physically demanding task as working hard. This is closer to the truth than it first appears. In physics the term work (or often **work done**) is another way of saying **energy** is being transferred from one object to another or transformed from one type to another.

- **Work done = energy transferred**

This means, like energy, work done is measured in **joules**. (The joule is the SI derived unit of energy). The more energy transferred the more work has been done. Work is a scalar quantity, just like energy.

### Calculating work done

Look back at the fishermen in Figure 4.1. As they pull the rope along they are transferring energy to their catch at the end of the rope. The harder they pull or the greater distance they travel, the more energy they transfer, the more work they do.

Mechanical work is defined as the amount of energy transferred by a force acting through a distance. We can calculate work done using the following equation:

- $W = F s$

$W$  = work done in J.

$F$  = average force applied (it is assumed to be constant) in N.

$s$  = the distance moved in the direction of the force in m.

Notice we usually use  $s$  instead of  $d$  or  $x$ . This is because the direction of the distance moved is really important. The distance travelled has to be in the direction of the force. Either in the same direction or in the opposite direction (this is often referred to as the distance against the force). If you are not pulling or pushing against a force then you are not doing any work. We use  $s$  because the distance has a specific direction; therefore it can be considered to be a displacement.

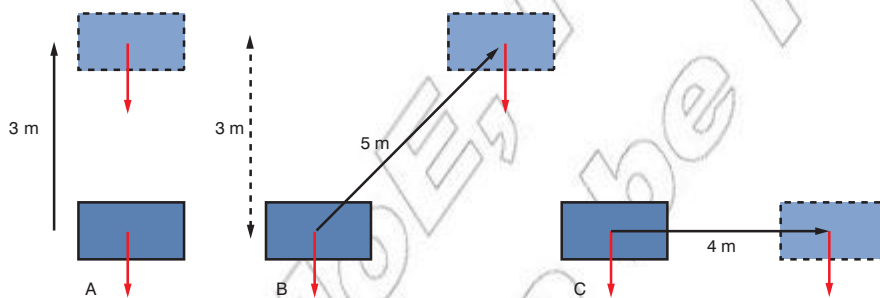
- **Mechanical work may be defined as the product of displacement and the force in the direction of the displacement.**

In both examples in Figure 4.3 work is being done, energy is being transferred or transformed. The first example involves pulling a trolley along the ground against a frictional force of 2 N. The second involves lifting a 2 N book. In both cases the distance moved against the force is 3 m and so 6 J of work has been done.

- $W = F s$
- $W = 2 \text{ N} \times 3 \text{ m}$
- $W = 6 \text{ J}$

Looking at the second example the direction of the force is vertically downwards (it is the weight of the book). Therefore it is only the vertical distance moved that is important.

Look at Figure 4.4. Assuming the book weighs 2 N and there are no other forces acting, how much work is done in each case?



**Figure 4.4** The distance moved must be in the opposite direction to the force.

In example A the work done is simple to calculate:  $W = F s$ ,  $W = 6 \text{ J}$ .

Example B is more complex and serves to illustrate the importance of working against the force. The book has been moved 5 m. However, it has only been moved 3 m vertically. It is this distance, the distance against the force, which we use in our calculation.

$W = F s$  *State principle or equation to be used (definition of mechanical work)*

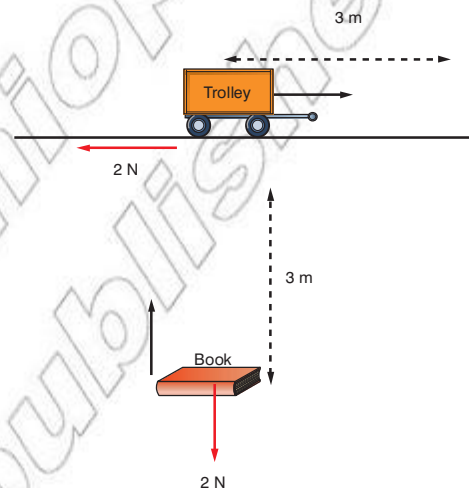
$W = 2 \text{ N} \times 3 \text{ m}$  *Substitute in known values and complete calculation*

$W = 6 \text{ J}$  *Clearly state the answer with unit*

So in both A and B the work done is 6 J. The energy transferred to the book is 6 J in each case.

### DID YOU KNOW?

One joule is defined as the work done when a force of 1 N moves through a distance of 1 m. So  $1 \text{ J} = 1 \text{ N} \times 1 \text{ m}$ .



**Figure 4.3** Two examples of doing work, for example lifting a book to place it on a shelf or pushing a shopping trolley through a store.

### DID YOU KNOW?

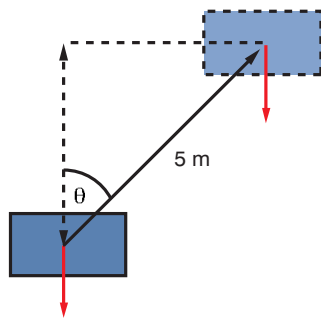
As well as mechanical work you can do electrical work on an object. The equation for electrical work done is  $W = VIt$ , where  $V$  is the potential difference in volts,  $I$  is current in amperes and  $t$  is time in seconds.

### KEY WORDS

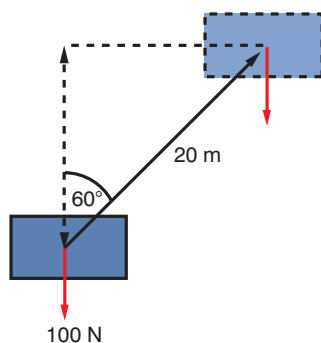
**energy** the stored ability to do work

**joule** the SI unit of work and energy

**work / work done** the amount of energy transferred when an object is moved through a distance by a force



**Figure 4.5**  $\theta$  is the angle between the direction of movement and the direction of the force.



**Figure 4.6** A box lifted up at an angle

### Think about this...

If the angle between the force and distance moved is  $0^\circ$  (i.e. they are parallel) then  $\cos \theta = \cos 0^\circ = 1$ . The equation  $W = F s \cos \theta$  becomes  $W = F s$ , as used in the earlier examples.

In example C in Figure 4.4 the book moves 4 m. However, it does not move any distance against the force (it does not move vertically). Therefore

$$s = 0 \text{ m.}$$

- $W = F s$
- $W = 2 \text{ N} \times 0 \text{ m}$
- $W = 0 \text{ J}$

So in example C no work has been done. No energy has been transferred to the book.

A more complex version of the work equation can be seen below.

$$W = F s \cos \theta$$

$s$  is the distance travelled.

$\theta$  is the angle between the force and the direction of movement.

If you think about this equation,  $s \cos \theta$  is really the distance moved in the direction of the force.

For example, Figure 4.6 shows a 100 N box lifted 20 m at an angle of  $60^\circ$  to the vertical.

The work done would be:

$$W = F s \cos \theta \text{ State principle or equation to be used (definition of mechanical work)}$$

$$W = 100 \text{ N} \times 20 \text{ m} \times \cos 60^\circ \text{ Substitute in known values and complete calculation}$$

$$W = 1000 \text{ J} \text{ Clearly state the answer with unit}$$

## Doing work against gravity, friction, and gravity and friction!

### Gravity

Work is often done against gravity. Whenever you lift up an object you are doing work against the force of gravity. In this case the force you are working against is the weight of the object. We can adapt our work done equation for working against gravity:

- $W = F s$
- Work done against gravity = weight  $\times$  vertical distance moved (or  $W_{\text{gravity}} = w \times h$ )

The work done in lifting a 60 kg mass vertically 3 m can be found using the work done equation:

$$W_{\text{gravity}} = w \times h \text{ State principle or equation to be used}$$

$$w = mg, w = 60 \text{ kg} \times 10 \text{ N/kg} = 600 \text{ N} \text{ Calculate weight from known values}$$

$$W_{\text{gravity}} = 600 \text{ N} \times 3 \text{ m} \text{ Substitute in known values and complete calculation}$$

$$W_{\text{gravity}} = 1800 \text{ J} \text{ Clearly state the answer with unit}$$

Remember, it must be the vertical distance moved and weight acts vertically.

## Friction

Whenever you push an object along the ground you are working against a force of kinetic friction.

Kinetic friction always acts in the opposite direction to motion. In Unit 3 we learnt that:

$$F_{\text{friction}} = \mu_{\text{kinetic}} N$$

This is the force you are working against. We can adapt our work done equation for working against frictional forces:

- $W = F s$
- Work done against friction = force due to kinetic friction  $\times$  distance moved
- $W_{\text{friction}} = \mu_{\text{kinetic}} N \times s$

For example, we can determine the work done in pushing a 100 kg wooden block 30 m across a horizontal concrete floor with  $\mu_{\text{kinetic}} = 0.48$

$$W_{\text{friction}} = \mu_{\text{kinetic}} N \times s$$

In this case the normal contact force is equal to the weight (as the floor is horizontal) and so

$$N = w = mg \quad \text{Express } N \text{ in terms of weight}$$

$$N = 100 \text{ kg} \times 10 \text{ N/kg} \quad \text{Substitute in known values and complete calculation}$$

$$N = 1000 \text{ N} \quad \text{Clearly state the answer with unit}$$

$$W_{\text{friction}} = \mu_{\text{kinetic}} N \times s \quad \text{Express } W_{\text{friction}} \text{ in terms of frictional force and distance moved}$$

$$W_{\text{friction}} = 0.48 \times 1000 \text{ N} \times 30 \text{ m} \quad \text{Substitute in known values and complete calculation}$$

$$W_{\text{friction}} = 14\,400 \text{ J or } 14.4 \text{ kJ} \quad \text{Clearly state the answer with unit}$$

This energy has been transformed into **heat energy** where the block and surface rub together.

## Gravity and friction

If you were to push or pull on object up a ramp then you end up doing work against both friction and gravity!

In this case the total work done could be found using the following equation:

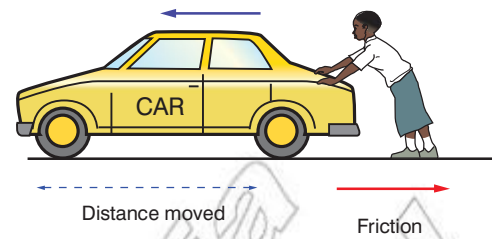
- **Total work done = work done against gravity + Total work done = work done against friction**

Work done against gravity = weight  $\times$  vertical distance moved.

$$W_{\text{gravity}} = w \times h$$

Work done against friction = force due to kinetic friction  $\times$  distance moved up ramp.

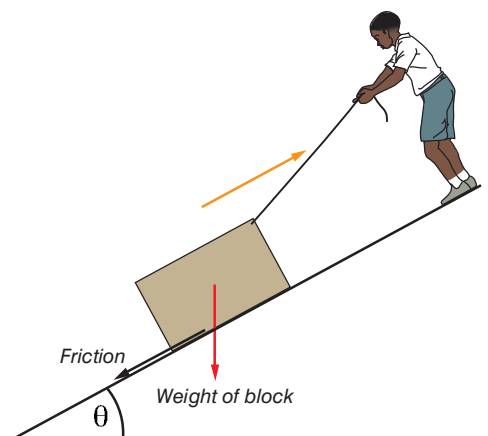
$$W_{\text{friction}} = \mu_{\text{kinetic}} N \times s$$



**Figure 4.7** Working against friction

### KEY WORDS

**heat energy** energy that is transferred between two objects as a result of their difference in temperature



**Figure 4.8** Working against friction and gravity



### Think about this...

Using the equations in Unit 3 and trigonometry can you show how we might expand the final equation to:

$$W_{total} = (w \times s \sin \theta) + (\mu_{kinetic} \times w \cos \theta \times s)$$

### KEY WORDS

**graph** a drawing showing how two or more sets of numbers are related to each other

**area under the line** the area between the line on a graph and the axes

**calculus** a type of mathematics that deals with rates of change

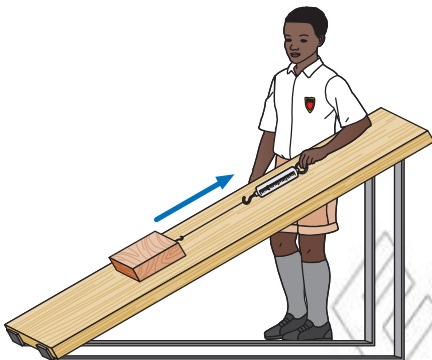


Figure 4.9 Pulling an object up a ramp

So:

$$W_{total} = (w \times h) + (\mu_{kinetic} N \times s)$$

We have to be very careful in considering the distances we use in this equation;  $h$  has to be the vertical distance, as this is the distance moved against gravity, whereas  $s$  must be the distance moved up the slope as friction acts down the slope.

### Worked example

Using the wooden block earlier we can determine the work done if the block was pulled 20 m up a ramp at an angle of  $30^\circ$ .

- **Total work done = work done against gravity + work done against friction.**

Work done against gravity:

$$W_{gravity} = w \times h \quad \text{Express } W_{gravity} \text{ in terms of force (weight) and distance moved (height lifted)}$$

In this case  $w = mg = 100 \text{ kg} \times 10 \text{ N/kg} = 1000 \text{ N}$ .  $h =$  vertical distance moved, which, using trigonometry,  $= s \sin \theta = 20 \text{ m} \times \sin 30^\circ = 10 \text{ m}$ .

$$W_{gravity} = 1000 \text{ N} \times 10 \text{ m} \quad \text{Substitute in known values and complete calculation}$$

$$W_{gravity} = 10\,000 \text{ J} \quad \text{Clearly state the answer with unit}$$

Work done against friction:

$$W_{friction} = \mu_{kinetic} N \times s \quad \text{Express } W_{friction} \text{ in terms of frictional force and distance moved}$$

In this case  $\mu_{kinetic} = 0.48$ ,  $s = 20 \text{ m}$  and  $N = w \cos \theta$  (see Unit 3)  $= 1000 \text{ N} \times \cos 30^\circ = 866 \text{ N}$

$$W_{friction} = 0.48 \times 866 \text{ N} \times 20 \text{ m} \quad \text{Substitute in known values and complete calculation}$$

$$W_{friction} = 8313.6 \text{ N} \text{ or } 8300 \text{ N} \quad \text{Clearly state the answer with unit}$$

Total work done:

$$W_{total} = W_{gravity} + W_{friction} \quad \text{Simple expression of total work done}$$

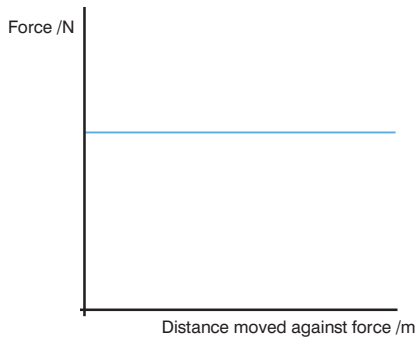
$$W_{total} = 10\,000 \text{ J} + 8300 \text{ J} \quad \text{Substitute in known values and complete calculation}$$

$$W_{total} = 18\,300 \text{ J} \quad \text{Clearly state the answer with unit}$$

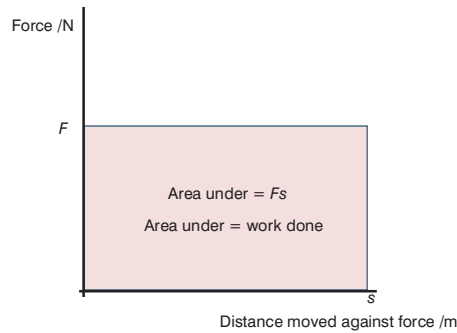
### What if the force varies?

If the force applied *varies* we can't use the  $W = F s \cos \theta$  equation to find the work done. We need a different technique to calculate the work done.

We can plot a **graph** of the force applied against the distance travelled against the force.



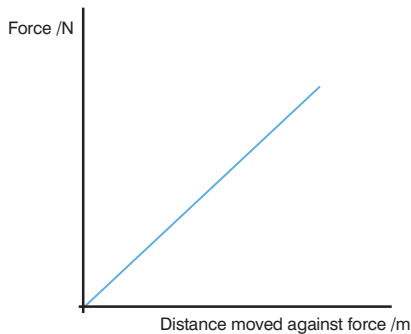
**Figure 4.10** A graph showing a constant force acting over a distance



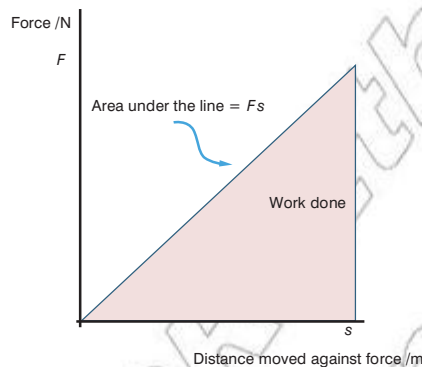
**Figure 4.11** The area under a force vs. distance moved graph is equal to the work done.

### DID YOU KNOW?

You could use some powerful mathematics called **calculus** to determine the area under the line. Newton invented this kind of mathematics to help him solve complex problems relating to the motion of objects.



**Figure 4.12** A graph showing a force that increases as the distance moved increases



**Figure 4.13** The area under the line still represents the work done.

### Think about this...

Hooke's law produces a graph very similar to Figure 4.12. In fact the area under the line in this case represents the work done on the spring. That is, the energy stored by the spring. You can work out the energy stored using the equation  $W = \frac{1}{2}F\Delta x$ .

The **area under the line** is equal to  $Fs$ ; it is equal to the work done. Increasing the distance moved or increasing the force both increases the area under the line and so more work has been done.

What if the force was not constant but gradually increasing? You might get a graph that looks like Figure 4.12.

In this case the area under the line is a triangle. This area is still equal to the work done.

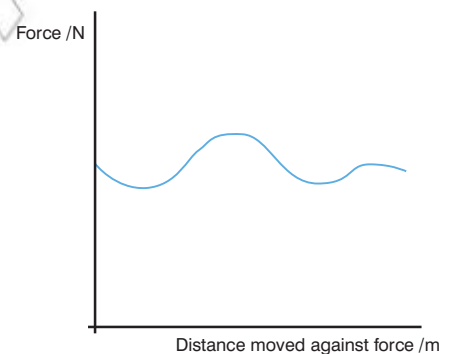
What if the force varied in a more complex way? Take, for example, Figure 4.14. This might be a varying force of friction as a box is dragged over different surfaces.

Remember the area under the line is still equal to the work done. But how do we calculate it?

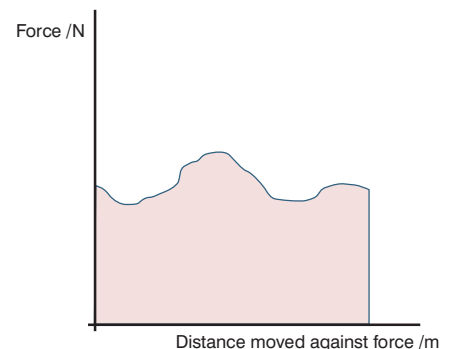
In order to determine the area under the line we need to count the squares under the line and then use this to calculate the work done.

Take a small square under the line and calculate the area of this square. For example, if the square is 20 N high and 0.1 m across the area is equal to:

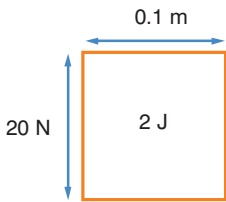
- area of one square = 20 N  $\times$  0.1 m
- area of one square = 2 J.



**Figure 4.14** A graph showing a force that changes in a complex way as distance increases



**Figure 4.15** No matter how complex the force vs. distance moved graph, the area under the line is still equal to the work done.



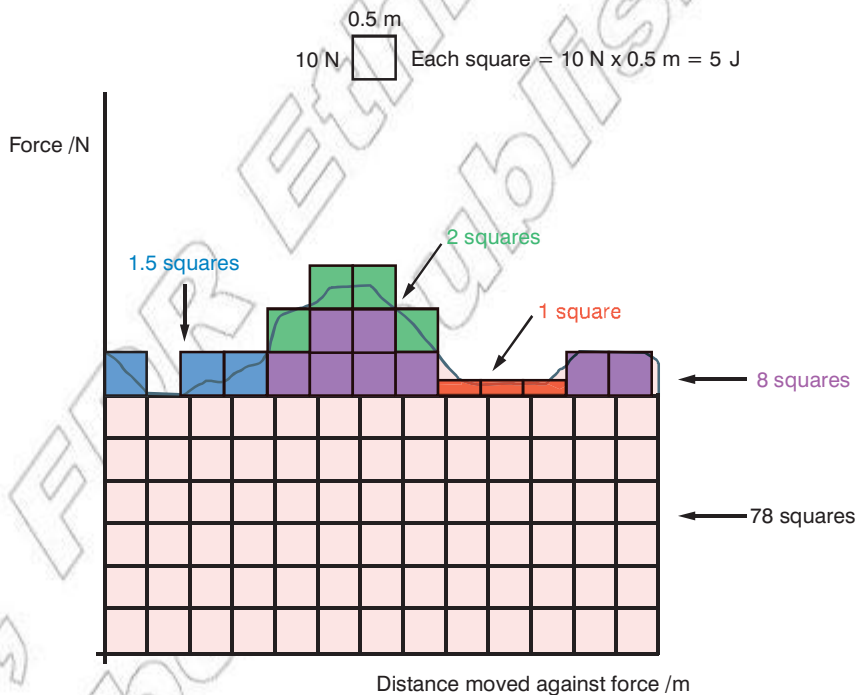
**Figure 4.16** The area of one square represents a small amount of the total work done.

This small square represents 2 J of work done. We need to count up all the squares and then multiply this by 2 J to determine the total work done. For example, if there are 100 squares the total work done would be:

- **total work done = number of squares × work done for each square**
- total work done =  $100 \times 2 \text{ J} = 200 \text{ J}$ .

If there were 500 squares the total work done would be 1000 J, etc.

You must be careful when counting the squares. You need to make a few estimations near the line. For example:



**Figure 4.17** Counting the squares often involves some estimation close to the line.

In Figure 4.17 there are a total of 90.5 squares. We have had to estimate some of those near the line. The three small red areas add up to one complete square, the four green areas add up to two squares, etc.

In this case the total work done is equal to:

- total work done = number of squares × work done for each square
- total work done =  $90.5 \times 5 \text{ J}$
- total work done = 452.5 J (approximately 450 J).

Although this is only an approximate value if you are careful counting the squares you will get very close to the true value of the work done.

**+W or -W?**

Work may be expressed as a **positive** or **negative** value. Remember, work is a scalar quantity and the opposite sign does not mean the opposite direction.

Instead, whether the work is positive or negative depends on whether or not the object gains or loses energy.

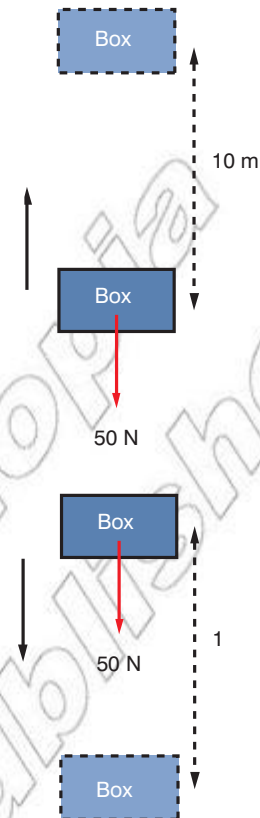
In both cases in Figure 4.18 the work done is 500 J. In the first case we can say work is done *on* the box. It gains 500 J of energy.

In the second case the box loses 500 J of energy. We can express this as -500 J or we could say the work done *by* the box is 500 J.

**Summary**

In this section you have learnt that:

- Work done is another way of saying energy transferred.
- Mechanical work is done whenever you move a force through a distance.
- The work done may be found using the equation:  
 $W = F s \cos \theta$
- Work done may be positive or negative depending on whether the object in question gains or loses energy.



**Figure 4.18** Work being done on or by a moving box

**Review questions**

1. Explain the meaning of the term work done and give an example of where work is done.
2. Calculate the total work done in the following examples:
  - a) A 20 kg log lifted 2 m into the air
  - b) Thirty 6 kg boxes lifted onto a shelf 1.5 m high
  - c) A car of mass 1400 kg pushed 50 m along a road ( $\mu_{kinetic} = 0.3$ )
  - d) A concrete slab of mass 200 kg pulled 10 m up a slope at an angle of  $30^\circ$  to the horizontal ( $\mu_{kinetic} = 0.6$ ).
3. Describe in detail how you would determine the work done by a varying force.
4. Explain the difference between positive and negative work done.

**KEY WORDS**

**negative** less than zero  
**positive** greater than zero



**Figure 4.19** It takes energy to play football.

### DID YOU KNOW?

A common definition for energy is capacity to do work. The more energy an object has the more work it can do! The term energy comes from the Greek word 'energeia' meaning activity or operation.

### Activity 4.1: Energy examples

Can you give examples of where you might come across each of the forms of energy listed in Table 4.1?

### KEY WORDS

**forms types**  
**motion** the act of moving or the way an object moves

## 4.2 Work–energy theorem

By the end of this section you should be able to:

- Explain the relationship between work and energy.
- Derive the relationship between work and kinetic energy and use this to solve problems.
- Show the relationship between work and potential energy as  $W = -\Delta U$  and use this to solve problems.
- Describe gravitational potential energy and elastic potential energy.
- Explain mechanical energy as the sum of kinetic and potential energy.

### Energy vs. work?

Energy and work are really just different ways of looking at the same thing. The energy of an object is a mathematical representation of the amount of work an object can do. Whereas work is any energy transferred to or from the object, energy refers to the total amount of work the object could theoretically do. In algebraic terms:

- $\Delta E = W$

Both energy and work are scalar quantities measured in joules.

### Forms of energy

There are several different **forms** of energy. These include:

**Table 4.1** Different types of energy

Kinetic energy	Gravitational potential energy
Heat energy	Elastic potential energy (strain)
Sound energy	Chemical energy
Electromagnetic energy (light)	Nuclear energy
Electrical energy	

The forms of energy on the left hand side of Table 4.1 are all energies associated with a kind of movement, whereas the forms of energy on the right are all to do with storing energy due to the particular arrangement of objects. **Remember, all forms of energy are scalar quantities measured in joules.**

### Kinetic energy

Any object in **motion** has a kinetic energy ( $E_k$ ). The amount of energy depends on the mass of the moving object and how fast it is travelling. Kinetic energy is calculated using the equation below:

- **kinetic energy** =  $\frac{1}{2}mv^2$

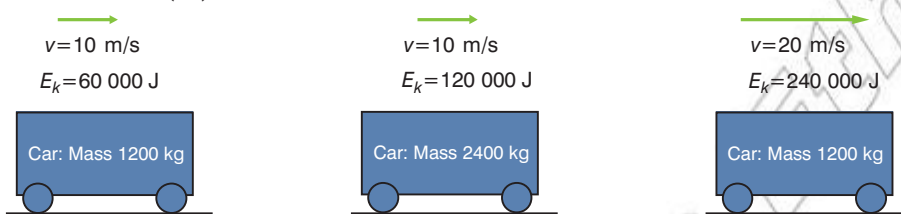
For example, a car of mass 1000 kg travelling at 12 m/s will have a kinetic energy of:

$$E_k = \frac{1}{2}mv^2 \quad \text{State principle or equation to be used}$$

$$E_k = \frac{1}{2} \times 1000 \text{ kg} \times (12 \text{ m/s})^2 \quad \text{Substitute in known values and complete calculation}$$

$$E_k = 72\,000 \text{ J or } 72 \text{ kJ} \quad \text{Clearly state the answer with unit}$$

An object with double the mass travelling at the same speed will have twice the kinetic energy. Mass and kinetic energy are directly proportional. However, if you double the velocity of an object its kinetic energy will increase by a factor of four ( $2^2$ ). This relationship is not directly proportional; instead  $E_k$  is directly proportional to  $v^2$ . If the velocity increases by a factor of five the  $E_k$  will increase by a factor of 25 ( $5^2$ ).



**Figure 4.20** The effect of mass and velocity on the kinetic energy of an object

### Why does $E_k = \frac{1}{2}mv^2$ ?

This equation comes from combining Newton's first and second laws of motion and one of the equations for constant acceleration.

Part of the work–energy theorem states:

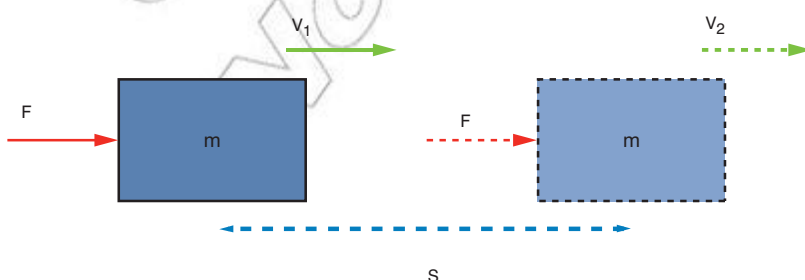
- If an external force acts upon an object it will cause its kinetic energy to change from  $E_{k1}$  to  $E_{k2}$ . The net work done on a body equals its change in kinetic energy.

This statement should make sense. Work done is energy transferred. If a resultant force is applied to an object it will accelerate (Newton's first law). As a result it will change its kinetic energy and this change will be equal to the energy transferred (or work done).

In terms of equations we have:

- Work done = change in kinetic energy
- $W = \Delta E_k = E_{k2} - E_{k1}$
- $W = \frac{1}{2}mv_2^2 - \frac{1}{2}mv_1^2$
- $W = \frac{1}{2}m(v_2^2 - v_1^2)$

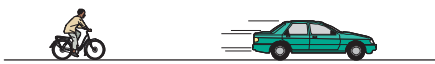
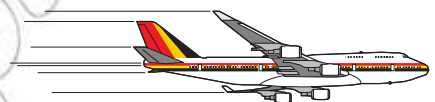
This does not show where  $E_k = \frac{1}{2}mv^2$  comes from; however, we can derive this equation another way to show that it is valid.



**Figure 4.22** Deriving  $E_k = \frac{1}{2}mv^2$

### Activity 4.2: Kinetic energy of a car

Determine the kinetic energy of the car used in the worked example if it were travelling firstly at 16 m/s and then at 24 m/s.



**Figure 4.21** All moving objects have kinetic energy. In this picture the aircraft has the most  $E_k$ .

### Think about this...

Because  $E_k \propto v^2$  the velocity of a moving car has a significant impact on its stopping distance. Travelling at 50 km/h it may take 25 m to stop (depending on road conditions, etc). Double that, travelling at 100 km/h and it takes a massive 75 m to stop, much more than double the distance. This is because the brakes have to do more than double the work (as there is more than double the  $E_k$  and so the force has to act over a much greater distance).

### Worked example

A car of mass 800 kg is travelling at 12 m/s. The car accelerates over a distance of 240 m. The net force causing this acceleration is 200 N. Determine the work done on the car and its final velocity.

$W = F s$  *State principle or equation to be used (definition of mechanical work)*

$W = 200 \text{ N} \times 240 \text{ m}$  *Substitute in known values and complete calculation*

$W = 48\,000 \text{ J}$  *Clearly state the answer with unit*

You can calculate the final velocity in a number of different ways (including use one of the equations of constant acceleration). In this case we will use:

$$W = \frac{1}{2}m(v^2 - u^2)$$

$2 W / m = v^2 - u^2$  *Rearrange equation to give  $v^2 - u^2$  on right hand side*

$v^2 = (2 W / m) + u^2$  *Rearrange equation to make  $v^2$  the subject*

$v^2 = (2 \times 48\,000 \text{ J} / 800 \text{ kg}) + (12 \text{ m/s})^2$  *Substitute in known values and complete calculation for  $v^2$*

$v^2 = 264$  *Solve for  $v^2$  then take the square root to complete*

$v = 16 \text{ m/s}$  *Clearly state the answer with unit*

Starting from Newton's second law:

- $F_{net} = m a$

Our defining equation for work done:

- $W = F s$

So we could substitute in for  $F$  and we get:

- $W = m a s$

From the equations of constant acceleration we have:

- $v^2 = u^2 + 2as$

This can be written as:

- $as = (v^2 - u^2) / 2$

Combining this with our previous equation we get:

- $W = m (v^2 - u^2) / 2$

Or

- $W = \frac{1}{2}m(v^2 - u^2)$ .

### Activity 4.3: Final velocity

Check the final velocity in the worked example using one of the equations of constant acceleration.

### KEY WORDS

#### potential energy

*the ability of an object to do work as a result of its relative position*

**stored energy** *the potential ability of an object to do work as a result of its relative position or shape change*

### Potential energies

As previously mentioned the second column in our table of energies contains some different kinds of **potential energy**. They are effectively **stored energies**. They are all due the particular organisation or position of parts of the object/system of objects. The potential energy of an object is usually given the symbol  $U$ .

- Potential energy =  $U$**

If an object has a potential energy it can be thought of as storing some energy. This energy has the potential to do some work, i.e. the potential energy might be transformed into another form of energy and so work would be done (remember work done is just another way of saying energy has been transferred).

Imagine an object has a potential energy of 1000 J. If this object did 300 J of work then the potential energy remaining after the work has been done will be 700 J. In other words:

- Work done by object = drop in potential energy of object

Or in symbols:

- $W = -\Delta U$

Equally, if work is done on the object then its potential energy might increase (it is also fair to say its kinetic energy may also increase). This is really just another way of saying work done is equal to the energy transferred; we just need to think carefully about where that energy has come from.

## Gravitational potential energy

Perhaps the most common potential energy is **gravitational potential energy** (GPE). Any object with mass in a **gravitational field** has a GPE. How much GPE depends on three factors, its mass, the gravitational field strength ( $g$ ) and its position in the field.

We usually deal with GPE with reference to the surface of the Earth. Therefore, on the ground an object has 0 J of GPE.

- **Gravitational potential energy =  $mgh$**

$m$  = mass in kg.

$g$  = gravitational field strength (on Earth this is 10 N/kg or more precisely 9.81 N/kg).

$h$  = height above the ground.

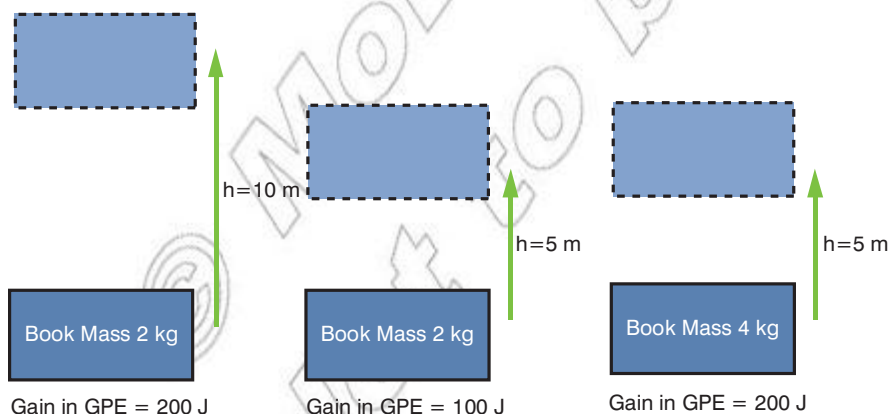
For example, an object of mass 30 kg at a height of 12 m has a GPE equal to:

GPE =  $mgh$  *State principle or equation to be used*

GPE = 30 kg  $\times$  10 N/kg  $\times$  12 m *Substitute in known values and complete calculation*

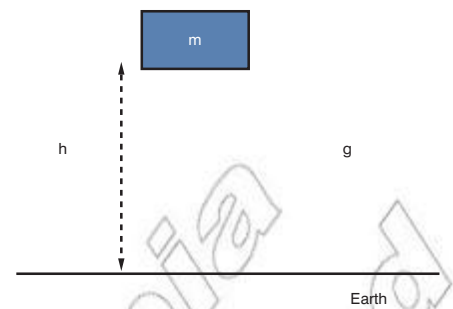
GPE = 3600 J *Clearly state the answer with unit*

An object with double the mass at the same height above the ground will have twice the GPE. Equally, an object twice as high above the ground will have double the GPE. Mass and height above the ground are both directly proportional to the GPE of the object.



**Figure 4.24** The effect of mass and height above the ground on the GPE of an object

If you think about when you do work by lifting up an object, you are transferring GPE to the object you are lifting. Looking back at the equations we can see they are both saying the same thing.



**Figure 4.23** Factors affecting the GPE of an object

### Activity 4.4: Calculating GPE

How high above the ground would a 10 kg object need to be to have the same GPE as the 30 kg object in the example?

### Think about this...

If an object has 0 J when on the ground how much GPE will an object have at the bottom of a well? It takes energy to lift the object out of the well. Work is done on the object and it gains energy to end up with 0 J. This must mean the GPE at the bottom of the well is less than 0 J. It must be a negative number! This is often referred to as a potential well.

### KEY WORDS

**gravitational field** *the space around an object in which the object's gravitational effect can be felt*

**gravitational potential energy** *the energy an object has due to its relative position above the ground*





Figure 4.25 A child's spring toy stores EPE.

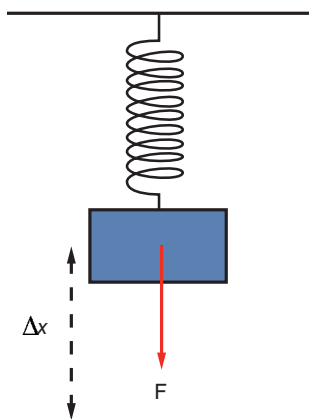


Figure 4.26 Factors affecting the EPE of an object

### Activity 4.5: Energy stored in a spring

Determine the energy stored in a spring that has a spring constant of 15 N/m and is extended by 20 cm.

- $W_{gravity} = w \times h$
- $GPE = mgh$

The energy gained by the mass (or the work done on the mass) is equal to weight multiplied by the vertical distance moved (the height above the ground).

### Elastic potential energy

Another common potential energy is **elastic potential energy** (EPE), sometimes called strain energy. This is the energy associated with any object that has been **stretched** or **compressed**. Think about compressing a spring in a toy; it will store energy, which it converts into kinetic energy as it bounces.

The amount of EPE stored in the spring depends on the force applied and the distance moved (i.e. the extension of the spring). Think back to the Hooke's law force vs. extension graphs studied in Unit 3. The area under the line is equal to the work done on the spring. This gives us the equation for EPE:

- **Elastic potential energy** =  $\frac{1}{2} F \Delta x$

$F$  = force in N.

$\Delta x$  = extension of spring in m.

For example, if a force of 100 N causes a spring to extend by 40 cm the energy stored in the spring will be equal to:

$EPE = \frac{1}{2} F \Delta x$  *State principle or equation to be used*

$EPE = \frac{1}{2} \times 100 \text{ N} \times 0.4 \text{ m}$  *Substitute in known values and complete calculation*

$EPE = 20 \text{ J}$  *Clearly state the answer with unit*

There is an alternative equation for EPE that includes the spring constant of the spring rather than the force applied. From Hooke's law

- $F = k \Delta x$

We can combine this with our equation for EPE and we get:

- Elastic potential energy =  $\frac{1}{2} k \Delta x \Delta x$

- **Elastic potential energy** =  $\frac{1}{2} k \Delta x^2$

### Total energies and energy changes

The total mechanical energy of a system is the sum of all the possible kinetic and potential energies.

- **Total mechanical energy** =  $\Sigma \text{kinetic energy} + \Sigma \text{potential energy}$

- **Total mechanical energy** =  $\Sigma E_k + \Sigma U$

An aircraft cruising at 10 000 m will have both a kinetic energy (as it is moving) and a potential energy (in this case GPE as it is above the ground). Its total mechanical energy will be its  $E_k + GPE$ .

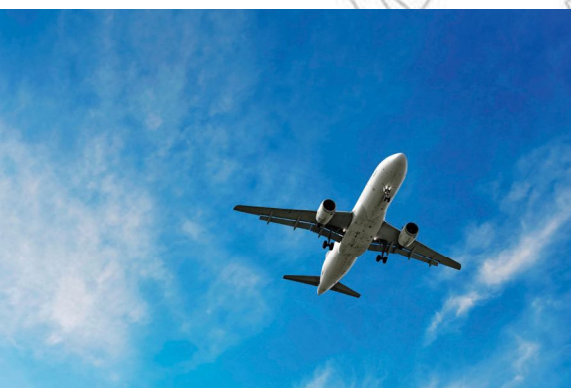


Figure 4.27 An aircraft flying through the air has both kinetic and potential energy.

## Summary

In this section you have learn that:

- When an object does work, the work done is equal to the change in energy of the object.  $W = \Delta E$ . Or  $W = -\Delta U$  if there is change in potential energy.
- Any moving object has a kinetic energy given by  $E_k = \frac{1}{2}mv^2$ .
- Potential energies are 'stored energies'. For example, GPE and EPE.
- $GPE = mgh$  and  $EPE = \frac{1}{2}F\Delta x$  (or  $\frac{1}{2}k\Delta x^2$ ).
- The total mechanical energy of an object is given by the sum of its kinetic and potential energies.

## Think about this...

Heat is another form of energy. The aircraft will also contain a certain amount of heat energy. However, this does not count towards its mechanical energy. More on heat in Unit 7.

## KEY WORDS

**compressed** *pressed or squeezed into a smaller space*  
**elastic potential energy** *the energy stored in a spring as a result of it being stretched or compressed*

**stretched** *made longer or wider by the application of force*

## Review questions

1. Use the work–energy theorem ( $W = \Delta E$ ) to show how  $W = \frac{1}{2}m(v_2^2 - v_1^2)$ .
2. Calculate the kinetic energy of the following objects:
  - a) a 75 kg human running at 8 m/s
  - b) a 3 g bullet travelling at 400 m/s
  - c) a car of mass 1200 kg that travels 60 m in 3 s.
3. Explain what is meant by the term potential energy and give four different examples of potential energies.
4. Calculate:
  - a) the GPE of a 15 kg wooden block 6 m above the ground
  - b) the height of the wooden block if it were to have a GPE of 300 J.
5. Calculate the energy stored in a spring when it is compressed 5 mm by a 60 N force.
6. Determine the mechanical energy of a bird of mass 200 g flying at 12 m/s at a height of 50 m above the ground.

## 4.3 Conservation of energy

By the end of this section you should be able to:

- State the law of conservation of mechanical energy.
- Revise the term collision and distinguish between elastic and inelastic collisions.



**Figure 4.28** A burning candle transforms chemical energy into heat and light energy.

- Solve problems involving inelastic collisions in one dimension using the laws of conservation of mechanical energy and momentum.
- Explain the energy changes that take place in an oscillating pendulum and an oscillating spring–mass system.
- Describe the use of energy resources including, wind energy, solar energy and geothermal energy.
- Explain the meaning of the term renewable energy.

## The law of conservation of energy

Perhaps the most important idea in all of physics, the **law of conservation of energy**, states:

- **The total energy of a closed system must remain constant.**

In essence this means energy cannot be *created* or *destroyed* only transferred from one place to another or transformed from one type to another. The energy has been **conserved**; it has not changed in value.

For example, when a candle burns we might say it ‘gives out’ heat and light. What we really mean to say is that the chemical energy in the candle is transformed into heat and light. The energy has not been created just transformed. Importantly, the amount of each type of energy must balance. If 200 J of chemical energy was converted into heat and light then there must be 200 J of heat and light energy, not 198 J or 202 J, exactly 200 J! Energy cannot be created or destroyed.

We often use terms like ‘wasted energy’ or ‘lost energy’ and we might say ‘it’s run out of energy’. In these cases we mean transformed into a form we don’t need or can’t use. Most energy is eventually transformed into heat. This is often wasted as it is not used by the device but transferred to the surroundings; the energy has not been destroyed.

Let’s think about what happens to the potential energy of a 5.0 kg mass when it is dropped from a height of 10 m. The total energy of a system must stay the same, but as the mass falls it ‘loses’ GPE. This GPE is converted into other forms. If we assume that the air resistance is negligible then the GPE will be converted into kinetic energy. The further it falls the faster it goes and the higher its kinetic energy.

Throughout the drop the total mechanical energy will be 500 J. When the mass hits the floor the kinetic energy will then be converted into 500 J of heat and sound energy.



**Figure 4.29** Filament bulbs ‘waste’ quite a lot of energy as heat.

### DID YOU KNOW?

The term closed system refers to a situation where objects are isolated from their wider surroundings. It is an idealised environment as the only totally closed system in the universe itself!

### Think about this...

In reality the block will hit the ground with just less than 500 J of kinetic energy. What would have happened to the rest of the energy?

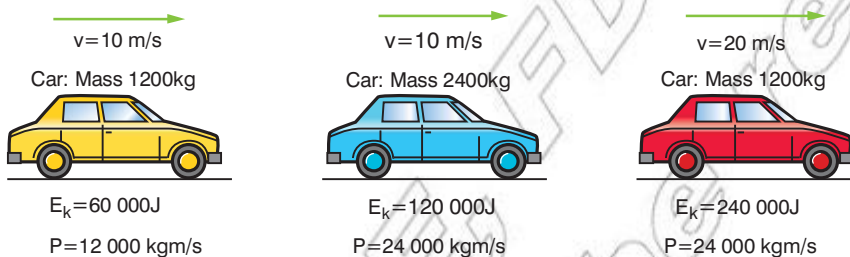
## Kinetic energy and momentum

**Kinetic energy** and **linear momentum** are two quantities that are very closely related. They both relate to moving objects with mass and both increase if the mass and/or the velocity of the objects increase, but not by the same proportion.

There are a few other important differences. Table 4.2 summarises some of the key points about kinetic energy and linear momentum.

**Table 4.2** Comparing linear momentum and kinetic energy

	Momentum	Kinetic energy
Unit	kg m/s	J
Type of quantity	Vector	Scalar
Equation	$p = mv$	$E_k = \frac{1}{2}mv^2$
Effect if mass doubles	Doubles	Doubles
Effect if velocity doubles	Doubles	Quadruples ( $2^2 = 4$ )
Conserved in collisions as long as no external force acts	Yes, always	Possibly, but not always



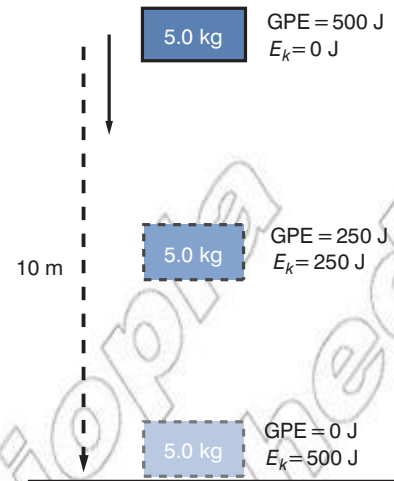
**Figure 4.31** The effect of changing mass and velocity on momentum and kinetic energy

Look carefully at Figure 4.31. You can see that both momentum and kinetic energy are directly proportional to the mass of the moving object. Double the mass and both the momentum and the kinetic energy double. However, if the velocity doubles, the momentum doubles, but the kinetic energy goes up by four.

## Elastic and inelastic collisions

Energy and momentum are two factors that are always conserved in collisions between objects. However, the energy may be transformed (for example, into heat and sound) and as a result the kinetic energy may not always be conserved.

We briefly looked at elastic and inelastic collisions in Unit 3. In an elastic collision the kinetic energy is conserved. In an inelastic collision the kinetic energy is not conserved.



**Figure 4.30** As an object falls GPE is transformed into  $E_k$ .

### Activity 4.6: Energy changes

Describe all the energy changes when a football is dropped onto the ground. Why does the ball not return to its original height?

### Activity 4.7: Kinetic energy and momentum

Calculate the kinetic energy and momentum of a mass of 10 kg travelling first at 6 m/s then at 12 m/s. Repeat for a mass of 20 kg.

### KEY WORDS

**conserved** neither increased nor destroyed

**closed system** a situation where objects are isolated from their environment

**law of conservation of energy** law stating that energy cannot be created or destroyed but is converted from one type to another

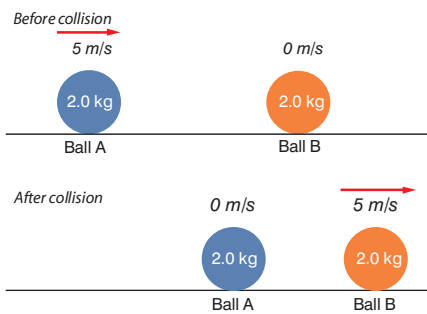


Figure 4.32 A perfectly elastic collision

### Activity 4.8: Collisions

Show that both kinetic energy and momentum are conserved in the collision shown in Figure 4.33. (Remember, momentum is a vector quantity, whereas kinetic energy is a scalar.)

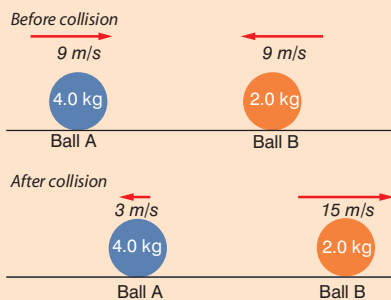


Figure 4.33 Is this an elastic collision?

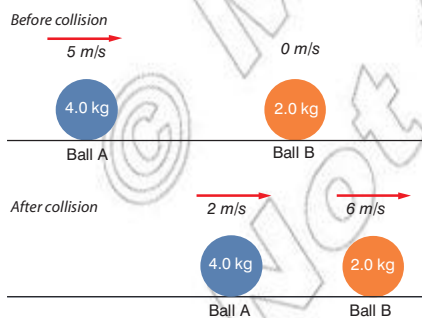


Figure 4.34 An inelastic collision

For example, Figure 4.32 shows a perfectly elastic collision. Both kinetic energy and momentum are conserved.

Momentum before =  $m_A v_A + m_B v_B = (2.0 \text{ kg} \times 5 \text{ m/s}) + (2.0 \text{ kg} \times 0 \text{ m/s}) = 10 \text{ kg m/s} \rightarrow$  Calculate momentum before as sum of momentum of A and momentum of B

Momentum after =  $m_A v_A + m_B v_B = (2.0 \text{ kg} \times 0 \text{ m/s}) + (2.0 \text{ kg} \times 5 \text{ m/s}) = 10 \text{ kg m/s} \rightarrow$  Calculate momentum after as sum of momentum of A and momentum of B

- Momentum before = momentum after; momentum has been conserved.

Kinetic energy before =  $\frac{1}{2}m_A v_A^2 + \frac{1}{2}m_B v_B^2 = (0.5 \times 2.0 \text{ kg} \times (5 \text{ m/s})^2) + (0.5 \times 2.0 \text{ kg} \times (0 \text{ m/s})^2) = 25 \text{ J}$  Calculate kinetic energy before as sum of KE of A and KE of B

Kinetic energy after =  $\frac{1}{2}m_A v_A^2 + \frac{1}{2}m_B v_B^2 = (0.5 \times 2.0 \text{ kg} \times (0 \text{ m/s})^2) + (0.5 \times 2.0 \text{ kg} \times (5 \text{ m/s})^2) = 25 \text{ J}$  Calculate kinetic energy after as sum of KE of A and KE of B

- Kinetic energy before = kinetic energy after; kinetic energy has been conserved and therefore it is a perfectly elastic collision.

Momentum is always conserved but kinetic energy is not. Figure 4.34 shows an example of an inelastic collision.

Momentum before =  $m_A v_A + m_B v_B = (4.0 \text{ kg} \times 5 \text{ m/s}) + (2.0 \text{ kg} \times 0 \text{ m/s}) = 20 \text{ kg m/s} \rightarrow$  Calculate momentum before as sum of momentum of A and momentum of B

Momentum after =  $m_A v_A + m_B v_B = (4.0 \text{ kg} \times 2 \text{ m/s}) + (2.0 \text{ kg} \times 6 \text{ m/s}) = 20 \text{ kg m/s} \rightarrow$  Calculate momentum after as sum of momentum of A and momentum of B

- Momentum before = momentum after; momentum has been conserved.

Kinetic energy before =  $\frac{1}{2}m_A v_A^2 + \frac{1}{2}m_B v_B^2 = (0.5 \times 4.0 \text{ kg} \times (5 \text{ m/s})^2) + (0.5 \times 2.0 \text{ kg} \times (0 \text{ m/s})^2) = 50 \text{ J}$  Calculate kinetic energy before as sum of KE of A and KE of B

Kinetic energy after =  $\frac{1}{2}m_A v_A^2 + \frac{1}{2}m_B v_B^2 = (0.5 \times 4.0 \text{ kg} \times (2 \text{ m/s})^2) + (0.5 \times 2.0 \text{ kg} \times (6 \text{ m/s})^2) = 44 \text{ J}$  Calculate kinetic energy after as sum of KE of A and KE of B

- Kinetic energy before > kinetic energy after; kinetic energy has been lost and therefore it is not a perfectly elastic collision.

In this example 6 J has been converted into heat and sound and so kinetic energy is not conserved and the collision is not perfectly elastic.

### Energy in oscillating systems

We have seen that when an object falls its GPE is converted into kinetic energy. The same is true if you throw an object into the air. Here the kinetic energy is transformed into GPE as it rises.

In oscillating systems kinetic energy is continuously being transformed into potential energy and vice versa. If there are no energy losses (e.g. no losses as heat) then the total mechanical energy will stay the same and this process will go on forever!

Take, for example, a pendulum as it swings.

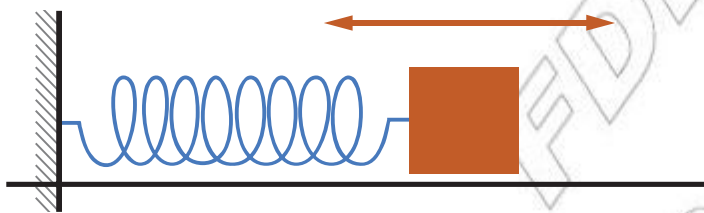
As it is lifted to A the pendulum gains GPE. It is then released and the gain in GPE is converted into  $E_k$ . At B it is travelling fastest, it has the most  $E_k$  but also the lowest GPE. It then rises to C, losing  $E_k$  and gaining GPE as it does so. Figure 4.36 shows how the potential energy and kinetic change over time.

From the graph you can see that the total mechanical energy stays the same. As the potential energy falls the kinetic energy increases and vice versa.

- **The total mechanical energy = kinetic energy + potential energy**

Another example of an oscillating system is a mass–spring system. In simple terms this is just a mass on the end of a spring. However, the suspension in a car is a more complex example of a mass–spring system.

In this case the potential energy may not be GPE, instead it may be EPE.



**Figure 4.37** An example of a mass–spring system

As the spring is compressed the EPE increases and the mass slows down (its  $E_k$  decreases). Eventually the mass will stop; at this point the EPE is at its maximum and the  $E_k$  is zero. The mass then accelerates as EPE is converted into  $E_k$ . This process continues.

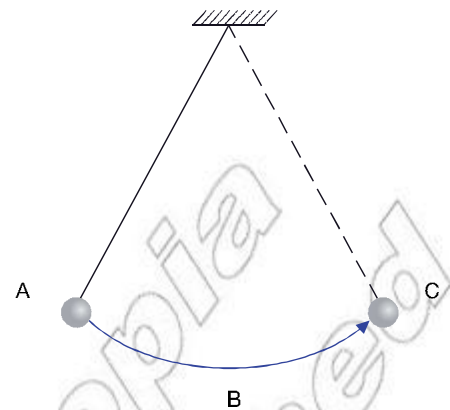
A more complex example might be a mass–spring system oscillating vertically like the one shown in Figure 4.38.

In this case the kinetic energy is changed into GPE and EPE. In any case the total mechanical energy of the system remains then same.

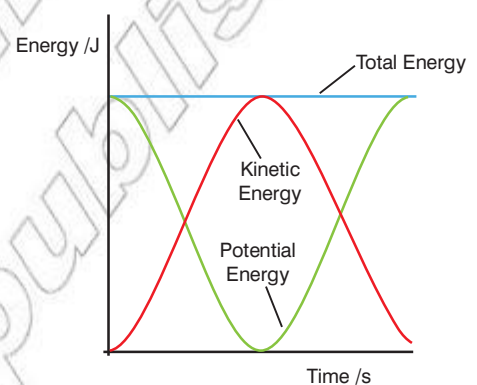
## Energy resources

Every country demands a huge amount of energy, from fuel to run cars and other vehicles, to gas for cooking and heating and, of course, electrical energy. A source of energy that may be used by a country or individuals within that country is commonly referred to as an **energy resource**. Energy resources are very precious commodities, perhaps the most obvious being oil.

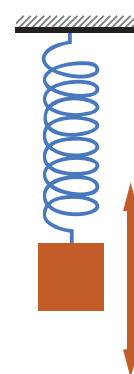
Selecting which energy resources to use is often a very difficult decision. There are lots of factors to consider, chief among them



**Figure 4.35** A simple pendulum transforms GPE into  $E_k$  and then back again.



**Figure 4.36** Graph showing how the potential energy and kinetic energy of oscillating systems are related



**Figure 4.38** A vertically oscillating mass–spring system

## KEY WORDS

**energy resource** a source of energy that can be used by a country or its population



Figure 4.39 A simple generator

### Think about this...

Remember energy cannot be created or destroyed, so when we talk about generating energy we really mean converting it from one form into electrical energy.



Figure 4.40 An example of a coal-fired power station

### KEY WORDS

**fossil fuels** *fuels that are produced by the action of high temperature and pressure on organic materials over millions of years*

**renewable resource** *an energy resource that does not involve a fuel that will run out*

being the availability of the resource, the economics involved and the subsequent environmental impact (more on this later).

Energy resources are often used to generate electricity. Electricity is exceptionally useful as it is quite simple to transfer a vast amount of energy from one place to another (all you need is a suitable wire!) and it can be easily transformed into most other forms of energy. Most methods of electricity generation involve a rotating turbine. This turbine turns a generator (a magnet or series of magnets inside coils of wire). This generator converts kinetic energy into electrical energy.

Globally the most common method for generating electricity involves the burning of **fossil fuels** such as coal, oil and natural gas. The chemical energy contained within these fuels is released as heat (through burning), this heat is used to turn water into steam, this steam then turns a turbine to generate electricity. Large fossil fuel power stations can generate up to 4 billion joules per second!

However, such a global reliance on fossil fuels is problematic for two main reasons.

- Fossil fuels are a finite energy resource. Eventually we will run out of coal, oil and natural gas.
- Burning fossil fuels produces several atmospheric pollutants, including sulphur dioxide and perhaps more worryingly, carbon dioxide. Carbon dioxide ( $\text{CO}_2$ ) is a powerful greenhouse gas. It is thought the increase in  $\text{CO}_2$  output is a significant factor in man-made global warming, heating up the entire planet and leading to dramatic changes to weather and climate.





Ethiopia has few proven fossil fuel resources. However, some people estimate that there is considerable potential for oil and natural gas exploration in the future.

In a nuclear power station uranium is used as a fuel. Inside the reactor there is a complex nuclear reaction (fission – splitting the atom). This process generates heat, which is used to turn water to steam, etc. The only real difference between a nuclear power station and a coal-fired one is the method for generating the heat. In a nuclear reactor a great deal of heat can be produced per kg of uranium, and so nuclear plants can generate vast amounts of electricity. As no fuel is ‘burnt’ there are no greenhouse gases produced; however, this process produces radioactive waste. This waste will remain dangerous for millions of years.


### Renewable energy resources

Resources that do not involve a fuel that will eventually run out are referred to as **renewable**. Table 4.3 includes a selection of some of the forms of renewable energy resources. This is not a definitive list; other forms include tidal (energy from tidal movements), wave (energy from water waves) and biomass (burning organic matter specifically grown for the task).

Table 4.3 Comparison of some renewable energy resources

Type	Description	Positives	Negatives
Wind 	The Sun heats the Earth's surface. This heating is uneven and so creates convection currents. This leads to areas of higher and lower pressure and wind moves between them. The wind turns large turbines and this generates electricity.	Relatively inexpensive – just running costs. Does not produce any greenhouse gases.	Not a consistent supply. When there is no wind there is no electricity generated. A large number of turbines are needed to generate a significant amount of power.
Geothermal 	Heat from processes inside the Earth is used to turn water into steam. Water is pumped down into 'hotspots' in the Earth's crust. It is turned to steam and this steam is used to turn turbines to generate electricity.	Only small amount of greenhouse gases are released (due to gases trapped inside the Earth being released in the process). Can generate a significant amount of power.	Only certain locations are suitable for geothermal power plants (see next section). Initial construction can be expensive.
Hydroelectric 	Falling water turns turbines to generate electricity. In order to provide a sufficient drop in height large dams are often constructed. The water builds up behind the dam and is then released through turbines.	Only a small amount of greenhouse house gases are produced. Very large amounts of energy can be generated with relatively small running costs. Hydroelectric plants tend to have longer lives than thermal power stations.	Construction of large dams can damage the local environment. This may affect a significant number of the local inhabitants (animal and human). Initial construction can be very expensive and is limited to only certain sites. Generation may be affected by extended droughts.
Solar (photovoltaic) 	The first type of solar power converts the energy in sunlight directly into electrical energy (via photovoltaic cells).	No greenhouse gases. Very low running costs.	Construction often involves the use of a large quantity of toxic materials. Photovoltaic cells remain very expensive. Only a relatively small amount of energy is generated per km <sup>2</sup> .



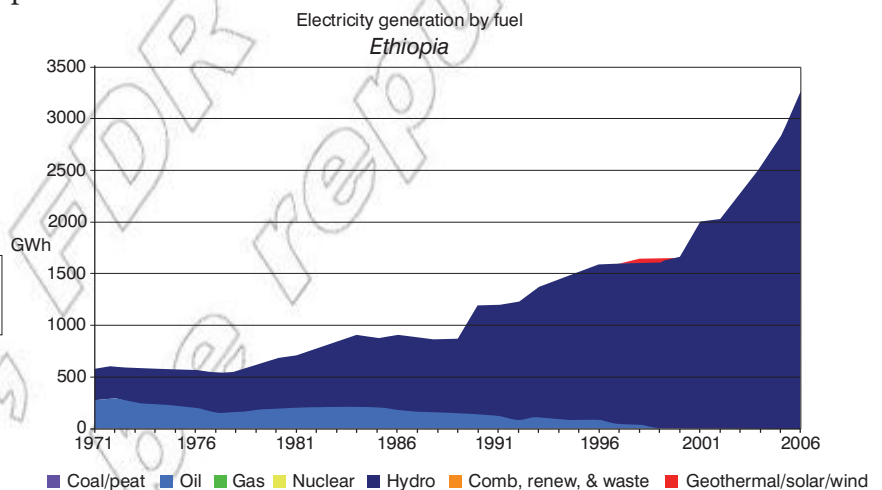
Type	Description	Positives	Negatives
Solar (concentrating solar power) 	The second type of solar power involves using carefully aligned mirrors to focus the sunlight onto a boiler. The heat turns water to steam and this turns a turbine.	Generates more energy per km <sup>2</sup> than photovoltaics. No greenhouse gases are produced.	Mirrors need to be very carefully aligned. Sophisticated technology is needed to ensure they track the Sun as it moves across the sky.

### Activity 4.9: Energy resources

Discuss with a partner where the energy utilised by different energy resources ultimately came from. (Hint: you may need to go back several billion years for most of them!)

### Energy in Ethiopia

In 2008 as a country we generated just over  $1 \times 10^{16}$  J (10 000 000 000 000 000 J!!) of electrical energy. At the time of writing around nearly all of our electricity generation comes from hydroelectric power.



**Figure 4.41** This graph shows the amount of electricity generated per resource.



**Figure 4.42** The location of hydroelectric power plants

As part of the country's general development plan, with the aim of expanding the Electric Power generation capacity, the Tekeze, Gilgel Gibe II and Tana Beles power plants with respective generating capacities of 300MW, 184MW and 460MW became operational in 2009 and 2010.

Reliance on hydroelectric power has advantages and disadvantages, as listed in Table 4.3. Ethiopia can diversify its electricity sources by exploiting its geothermal (> 5000 MW) and wind (>10 000MW ) electricity generating Potential. Figure 4.42 shows the location of several hydroelectric power plants. Ethiopia is among only a few African countries with the potential for significant energy generation to come from geothermal wind power.

## Summary

In this section you have learnt that:

- The law of conservation of energy states that energy cannot be created or destroyed, just converted from one type to another.
- In elastic collisions both kinetic energy and linear momentum are conserved. In an inelastic collision only momentum is conserved.
- In oscillating systems (such as simple pendulum or mass-spring systems) potential energy is continuously transformed into kinetic energy and back again.
- A renewable energy resource is one that does not involve a fuel that will eventually run out.
- Wind, solar, geothermal and hydroelectric energy resources all offer significant benefits; however, they each have their drawbacks.

## Review questions

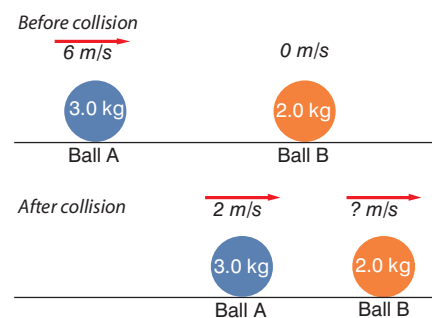
1. State the law of conservation of energy and explain why it is not correct to describe energy as being lost.
2. Use the principle of conservation of momentum to determine if the collision in Figure 4.44 is elastic or inelastic. If inelastic, calculate the amount of energy converted into heat and sound.
3. Describe the energy changes as a pendulum swings. If the pendulum has a mass of 50 g and is lifted so that it has a GPE of 0.1 J calculate:
  - a) its increase in height
  - b) the velocity of the bob as it passes through the bottom of the swing (assume no energy losses).
4. Explain what is meant by the term renewable energy resource and give three examples.
5. Describe how hydroelectric power may be used to generate electricity. Include the advantages and disadvantages of using this resource.

## DID YOU KNOW?

The enormous Three Gorges Dam in China can generate 22.5 GW of power. That's 22.5 billion joules per second! If running at full output this colossal project could generate the entire yearly output from Ethiopia in just over 5 days!



**Figure 4.43** The rift valley offers significant geothermal potential.



**Figure 4.44** What type of collision?

**KEY WORDS**

**per second** *a measurement of rate*

**power** *the rate of doing work*

**watt** *the unit of power*

**kilowatt-hour** *a unit of energy*

**4.4 Mechanical power**

By the end of this section you should be able to:

- Solve problems relating to the definition of power.
- Show that the kWh is also a unit of work.
- Express the formula of mechanical power in terms of average velocity.

**What is power?**

**Power**, like work, is another term that is frequently used in everyday language. It's a term that is often misused when maybe energy or velocity would be more appropriate.

In physics power has a very specific definition.

- **Power is the rate of doing work.**

As discussed in Unit 2, rate means **per second**. In other words, power is the work done per second. A greater power means more work is done per second or more energy is transferred per second.

Imagine two cars racing up a hill. If the cars have exactly the same mass, when they reach the top of the hill they would both have done the same amount of work. However, the more powerful car will be the winner (the one that can do the most work per second) as it will get to the top of the hill first!

An equation for average power is:

- **Power = work done / time taken**

$$P = W/t$$

$P$  = average power in W.

$W$  = work done in J.

$t$  = time in s.

Power is measured in **watts** (or kilowatts, etc). As energy is in joules and time in seconds, 1 watt is equal to 1 joule per second. A 4.0 kW motor can do 4000 J of work per second. The watt is the SI derived unit of power.

For example, a kettle uses 168 000 J of electrical energy in two minutes. Its average power can be found using the equation:

$$P = W/t \text{ State principle or equation to be used (definition of power)}$$

In this case the time taken is two minutes, which is 120 s.

$$P = 168\,000 \text{ J} / 120 \text{ s} \text{ Substitute in known values and complete calculation}$$

$$P = 1400 \text{ W or } 1.4 \text{ kW} \text{ Clearly state the answer with unit}$$

**Think about this...**

Technically the equation is for average power. However, if the rate of doing work is constant (for example, if the force you are working against and the speed of movement both remain constant) then the average power is the same as the actual power.

**DID YOU KNOW?**

The watt is named after the Scotsman James Watt. He was instrumental in the engineering of the late 18th century. In particular his developments on steam engines are widely credited to have brought about the industrial revolution.

If the same kettle were to run for five minutes how much work would the kettle do?

- $P = W/t$  *State principle or equation to be used (definition of power)*
- $W = P \times t$  *Rearrange equation to make W the subject*

In this case the time taken is five minutes, which is 300 s and  $P = 1400 \text{ W}$

- $W = 1400 \text{ W} \times 300 \text{ s}$  *Substitute in known values and complete calculation*
- $W = 420\,000 \text{ J}$  or  $420 \text{ kJ}$  *Clearly state the answer with unit*

This work would be transferred to the water and surroundings as heat energy.



**Figure 4.45** One 'horsepower' is around 750 W.

### Activity 4.10: The power of a student

You do work when you run up stairs, because you have to move your weight upwards. The faster you run, the greater your power.

- Weigh a volunteer student.
- Use a stopwatch to measure the time the student takes to run up a flight of stairs.
- Count the number of stairs. Measure the *vertical* height of one stair, and calculate the total height of the stairs.
- Calculate the work done (= weight  $\times$  height).
- Calculate the student's power (=  $\frac{\text{work done}}{\text{time taken}}$ )



**Figure 4.46** Lifting an apple around 1 m into the air transfers about 1 J of GPE to the apple.

### The joule, the watt and other units

We have already mentioned the Joule as the standard unit of energy and the **watt** as the unit of power.

However, a joule is quite a small unit. Lifting an apple around 1 m in the air and you would do 1 J of work. It's not much. When we deal with large-scale energy usage, in particular electricity demands and generation, an alternative unit is used.

The **kilowatt-hour** is an alternative unit of energy. It is the energy transformed by a 1 kW device in 1 hour. This means 1 kWh is equivalent to 3.6 million J.

We can still use our equation for power but we must consider the units carefully.

### Activity 4.11: Power calculation

Use the equation for power to show that 1 kWh is equal to 3.6 million J.

### DID YOU KNOW?

The joule was named after the English physicist James Prescott Joule. He was born on Christmas Eve in 1818 and he has been described by some as the quintessential physicist. He conducted a series of incredibly precise experiments that led to the theory of conservation of energy.

**Table 4.4** Comparing the joule and the kilowatt-hour

Joule	Kilowatt-hour
<ul style="list-style-type: none"> <li>• Work done = power <math>\times</math> time</li> <li>• [J] = [W] <math>\times</math> [s]</li> </ul>	<ul style="list-style-type: none"> <li>• Work done = power <math>\times</math> time</li> <li>• [kWh] = [kW] <math>\times</math> [h]</li> </ul>
Work done in J	Work done in kWh
Power in W	Power in kW
Time in s	Time in h

For example, how much work is done by a 500 W motor running for 30 minutes?

In joules:

$W = P \times t$  *State principle or equation to be used (definition of power in terms of W)*

In this case the time taken is 30 minutes, which is 1800 s, and  $P = 500$  W.

$W = 500 \text{ W} \times 1800 \text{ s}$  *Substitute in known values and complete calculation*

$W = 900\,000 \text{ J}$  or  $900 \text{ kJ}$  *Clearly state the answer with unit*

In kilowatt-hours:

$W = P \times t$  *State principle or equation to be used (definition of power in terms of W)*

In this case the time taken is 30 minutes, which is 0.5 hours, and  $P = 500$  W, which is 0.5 kW.

$W = 0.5 \text{ kW} \times 0.5 \text{ h}$  *Substitute in known values and complete calculation*

$W = 0.25 \text{ kWh}$  *Clearly state the answer with unit*

As well as the joule and kilowatt-hour, Table 4.5 lists some other commonly used units of energy.

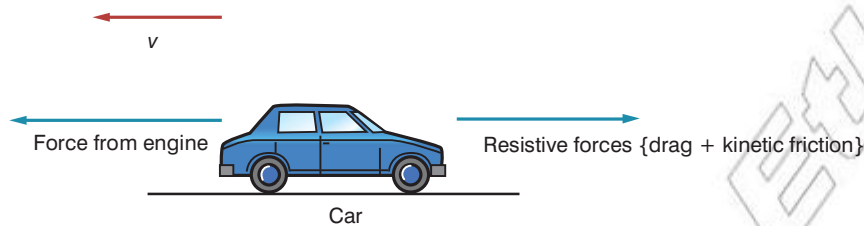
**Table 4.5** Different energy units

Unit	Application	Equivalent value (J)
Electronvolt (eV)	Sub-atomic particles and particle accelerators	$1.6 \times 10^{-19}$
Erg (erg)	Using cm, grams and seconds instead of m, kg and s	$1.0 \times 10^{-7}$
Kilocalorie (kcal)	Energy contained within foods	$4.2 \times 10^3$
Kilowatt-hour (kWh)	Unit of energy used by electricity suppliers or when comparing large-scale energy demands (GWh is also used).	$3.6 \times 10^6$
Tonne of oil equivalent (toe)	Another large-scale unit. It is the value of the chemical energy contained within one tonne of crude oil.	$4.2 \times 10^{10}$
Megaton (MT)	Nuclear weaponry; 1 MT is the energy released by 1 million tonnes of TNT exploding (the largest recorded detonation was around 50 MT).	$4.2 \times 10^{15}$

## Power and velocity

Imagine a car travelling along at a steady speed. Its engine is still running and it is still using fuel but the kinetic energy of the car is not changing. Where is the chemical energy going? It can't be destroyed.

For objects to move at steady speed through the air a force needs to be applied. Remember, forces don't make things move they make them change the way they are moving. In the case of an object moving through the air at a steady speed there must be no net force acting on it. The force from the engine must cancel out the resistive forces of kinetic friction and air resistance (drag).



**Figure 4.47** For a car to move at a steady speed there must be a force from the engine.

A force is being moved through a distance so work must be being done, but this energy is not transferred into the kinetic energy of the car as this is constant.

Instead the energy is transferred into two places:

- Heat energy (road – due to friction)
- Kinetic energy (including sound) of the air. A very turbulent wake is created behind the car.

If the engine is doing 4000 J of work per second then 4000 J of energy is transferred to the road and the air every second.

We can look at this process more mathematically by combining the equations for mechanical work and power and we get:

- Power = work done / time
- Power = force  $\times$  distance moved against force / time
- Average velocity = distance moved against force / time

So

- **Power = force  $\times$  velocity**
- **$P = F v$**

So, for a car to travel at 15 m/s against a force of 6000 N the power from its engine needs to be:

- $P = 6000 \text{ N} \times 15 \text{ m/s}$
- $P = 90\,000 \text{ W}$

This means the engine is converting 90 000 J of energy per second.

### Think about this...

In reality the amount of chemical energy from the fuel will be more than 90 000 J as the engine will not be 100% efficient.



**Figure 4.48** A train travelling at high speed does a great deal of work against air resistance and kinetic friction.

Looking at it another way, in order for a train to travel at 20 m/s its engine may have a power output of 800 000 W. This can be used to determine the force from the engine and so the magnitude of the resistive forces acting on the train.

$$P = F v \text{ State principle or equation to be used}$$

$$F = P / v \text{ Rearrange equation to make } F \text{ the subject}$$

$$F = 800\,000 \text{ W} / 20 \text{ m/s} \text{ Substitute in known values and complete calculation}$$

$$F = 40\,000 \text{ N} \text{ Clearly state the answer with unit}$$

### Summary

In this section you have learnt that:

- Power is defined as the rate of doing work (power = work done / time taken).
- Power is measured in watts (or kW) and 1 W is 1 joule per second.
- The scientific unit of work/energy is the joule. However, other units are commonly used, including the kilowatt-hour (kWh).
- For a moving object,  $P = Fv$ .

### Review questions

1. What is the definition of power, state its units and give two different equations for calculating the power of an object.
2. Calculate the power of the following:
  - a) a motor that does 24 000 J of work in two minutes
  - b) a crane that lifts a 60 kg mass 100 m in 60 seconds.
3. Calculate the work done in J by the following:
  - a) a 10 kW heater running for 15 minutes
  - b) two 100 W light bulbs on for 24 hours.
4. Recalculate the values in question 2, but this time express the work done in kWh.
5. Derive  $P = Fv$ .
6. Determine the power output from an aircraft travelling at 200 m/s working against resistive forces of 1000 N.

### End of unit questions

1. State the law of conservation of energy and describe a situation where  $W = -\Delta U$  could be used to illustrate this law.
2. Determine the work done when a forklift truck lifts a box of mass 350 kg a height of 2 m.
3. Calculate the work done if a boulder of mass 100 kg is rolled 40 m up a slope at an angle of  $20^\circ$ . Assume the force of friction is negligible.

4. As a block falls through the air by 40 m it does work equal to  $-1800$  J. Determine the mass of the block.
5. Calculate the kinetic energy of a ball of mass 50 g travelling at 30 m/s. How much work will need to be done to stop the ball?
6. A mass of 2.0 kg is hung off a spring, which extends 2 cm. Determine the energy stored in the spring.
7. A spring is used to launch a ball vertically into the air. The spring has a spring constant of 200 N/m and is compressed by 5 cm. A ball of mass 10 g is placed just above the spring. Calculate:
  - a) the energy stored in the spring
  - b) assuming the spring transfers all of its energy to the ball, the velocity of the ball just as it launches
  - c) the height reached by the ball assuming all the  $E_k$  is converted into GPE.
8. Describe the energy changes in a mass–spring system that is oscillating horizontally. Explain how this changes if the system is vibrating vertically.
9. An 8.0 kg ball travelling at 4 m/s collides head on with a 3 kg ball travelling at 14 m/s. The balls bounce off each other and travel back the way they came. The 8.0 kg ball travels away at 2 m/s. Calculate:
  - a) the velocity of the 3 kg ball after the collision
  - b) the kinetic energy before and after the collision.
  - c) State whether or not the collision is elastic and explain your answer.
10. Summarise the advantages and disadvantages of using the following energy resources to generate electricity:
  - a) coal
  - b) geothermal
  - c) wind
11. A man raises 100 kg from the floor to a height of 2 m in 2.5 s. What is the work done and the power developed?
12. A petrol engine raises 200 kg of water in a well from a depth of 7 m in 6 s. Show that the engine is developing about 2.33 kW of power.
13. It is proposed to use a small waterfall to turn an electricity generator.  $10\text{ m}^3$  of water fall 50 m per minute. Only one-fifth of its energy can be obtained usefully. Show that the water can develop 16.7 kW.
14. 300 kg of water are lifted 10 m vertically in 5 s. Show that the work done is 30 kJ and that the power is 6 kW.
15. Calculate the resistive forces acting on a sports car if it is travelling at a steady speed of 25 m/s when the engine is providing 200 kW.



Contents	
Section	Learning competencies
5.1 Purposes of machines (page 116)	<ul style="list-style-type: none"> <li>• Explain the purposes of a machine.</li> <li>• List the types of simple machines.</li> <li>• Determine whether the machines are force multipliers, speed multipliers or direction changers.</li> <li>• Define the terms load, effort, work output, work input, mechanical advantage (MA), velocity ratio (VR) and efficiency.</li> <li>• Derive the expression of <math>\eta = \text{MA}/\text{VR}</math> from its definition.</li> </ul>
5.2 Inclined plane, wedge and screw (page 124)	<ul style="list-style-type: none"> <li>• Derive an expression for MA of an inclined plane with or without friction.</li> <li>• Calculate MA, VR and efficiency of an inclined plane.</li> <li>• Calculate MA, VR and efficiency of a wedge.</li> </ul>
5.3 Levers (page 128)	<ul style="list-style-type: none"> <li>• Determine the MA, VR and efficiency of a lever.</li> <li>• Identify the orders of a lever and give examples.</li> <li>• Describe the use of a wheel and axle and determine MA, VR and efficiency of a wheel and axle.</li> <li>• Describe the use of gears.</li> <li>• Describe different pulley systems and calculate MA, VR and efficiency of a pulley system.</li> <li>• Describe the use of a jackscrew.</li> </ul>

Machines have made it possible for mankind to accomplish some truly amazing things, from building the ancient pyramids of Egypt to landing on the Moon. But it is not just these awe-inspiring achievements. Simpler machines are used in everything from cutting food and wood, to hanging a picture on the wall. Without machines there is no way our relatively weak bodies could lift blocks weighing thousands of newtons or even travel much faster than 5 m/s for long periods of time.

In this unit you will learn about what a machine is and why they enable us to lift heavy loads or move large distances. We will investigate the six classes of simple machines and learn about how to determine their efficiency and what mechanical advantage they offer us.

### 5.1 Purposes of machines

By the end of this section you should be able to:

- Explain the purposes of a machine.
- List the types of simple machines.

- Determine whether the machines are force multipliers, speed multipliers or direction changers.
- Define the terms load, effort, work output, work input, mechanical advantage (MA), velocity ratio (VR) and efficiency.
- Derive the expression of  $\eta = \text{MA}/\text{VR}$  from its definition.

## What are simple machines?

You could probably list hundreds of different machines. These might range from the vastly complex space shuttle, down to a simple pair of scissors.

A machine is a device that is specially designed or engineered to help make it easier to do **mechanical work**. Remember, from Unit 4 mechanical work is given by:

- $W = F s$

$W$  = work done in J.

$F$  = force applied.

$s$  = distance moved in the direction of the force.

A machine makes it easier to do work by performing one (or more) of the following:

- **increasing the magnitude of the applied force**
- **changing the direction of the applied force or transferring an applied force from one place to another**
- **increasing the distance moved against the applied force (or the speed the force moves).**

No machine can create extra energy (that would break the law of conservation of energy). In other words, the work you put in cannot be greater than the work you get out. However, as you can see from the list above it is possible to get more force out than you put in. We need to think about this carefully.

When you apply a force to a machine this is referred to as the **effort**. In order to do mechanical work you need to move this effort through a distance. Looking back at our equation for work we could rewrite this as:

- $W = F s$
- **Work input = effort  $\times$  distance moved by effort.**

The machine then provides a work output; this may be used to move a force (referred to as a **load**) through a distance). In equation terms:

$$W = F s$$

- **Work output = load  $\times$  distance moved by load.**



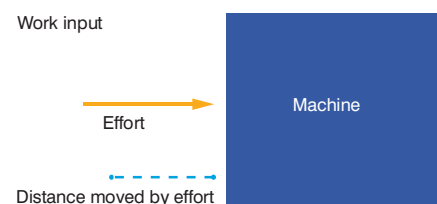
*Figure 5.1 Two very different machines!*

### KEY WORDS

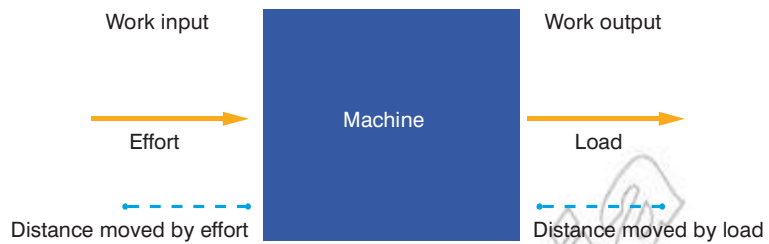
**effort** *the force applied to a machine*

**machines** *devices designed to make it easier to do mechanical work*

**mechanical work** *the amount of energy transferred when an object is moved through a distance by a force*



*Figure 5.2 Work input to a machine*



**Figure 5.3** A schematic of a machine

If there were no energy losses inside our machine then:

- **Work input = work output**
- **Effort × distance moved by effort = load × distance moved by load**

So, if the machine has been designed so the distance moved by the load is less than distance moved by the effort then the load can be greater than the effort. This means a small effort can be used to move a large load.

For example, imagine a machine that when an effort of 100 N is moved through 2 m it moves a load through a distance of 0.5 m. We can determine the maximum value of the load.

- $\text{Effort} \times \text{distance moved by effort} = \text{load} \times \text{distance moved by load}$
- $100 \text{ N} \times 2 \text{ m} = \text{load} \times 0.5 \text{ m}$
- $200 \text{ J} / 0.5 \text{ m} = \text{load}$
- $\text{load} = 400 \text{ N}$

The same logic could be used to show it is possible to move a smaller load a bigger distance than the distance moved by the effort.

The term, **simple machine**, refers to a machine that is, well, simple! This has lots of interpretations including:

- **a device that only requires a single force to work**
- **a device for doing work that has only one part**
- **a device that uses a single effort to do work against a single load force.**

Simple machines are often described as the elementary building blocks from which all other machines are made.

### Different types of simple machine

There are six different types of simple machine; we will look at each of them in turn later.

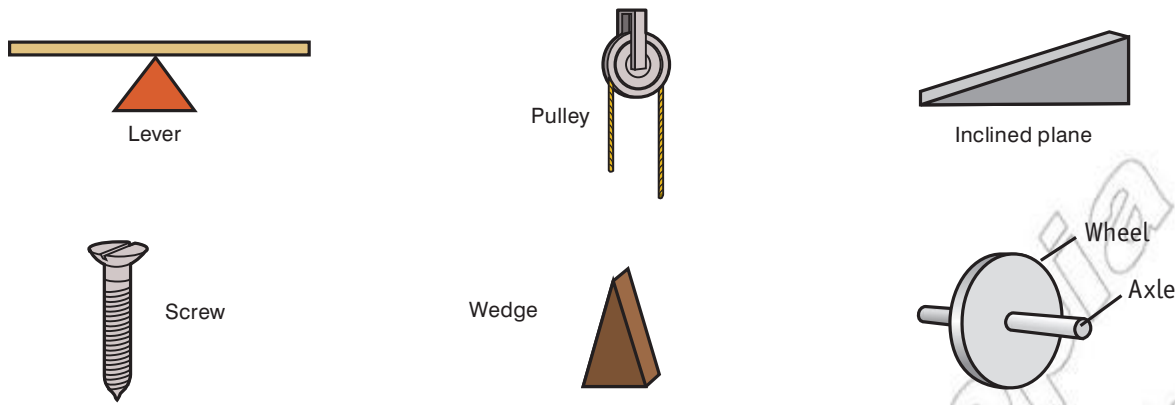
- **Inclined plane**
- **Lever**
- **Wedge**
- **Wheel and axle**
- **Screw**
- **Pulley**

### Think about this...

There are energy losses in every machine. This is usually due to **friction** between the moving parts of the machine. This transforms some of the work input into **heat energy**. As a result, the work input is always greater than the work output (more on this later).

### KEY WORDS

**simple machine** a device which requires a single effort to do work against a single force



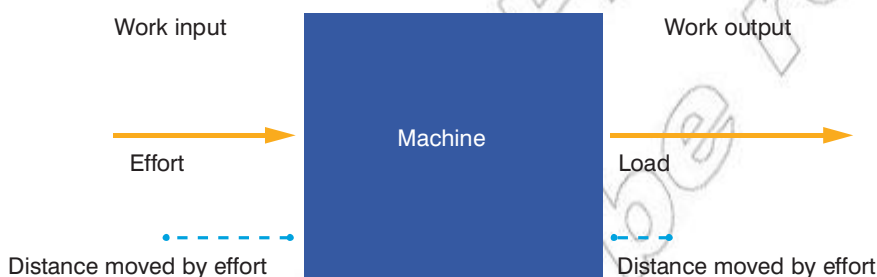
**Figure 5.4** The six different types of simple machines

Simple machines can be split into two groups. Wedges and screws can be thought of as special kinds of inclined planes. Pulleys and wheels and axles can be considered to be special kinds of levers. We will look at each group in turn in Sections 5.2 and 5.3.

No matter which type of simple machine we deal with they will fit into one or more of the following categories.

### Force multipliers

These are machines designed so that the *load is greater than the effort*. This is only possible if the load moves through a smaller distance than the effort.



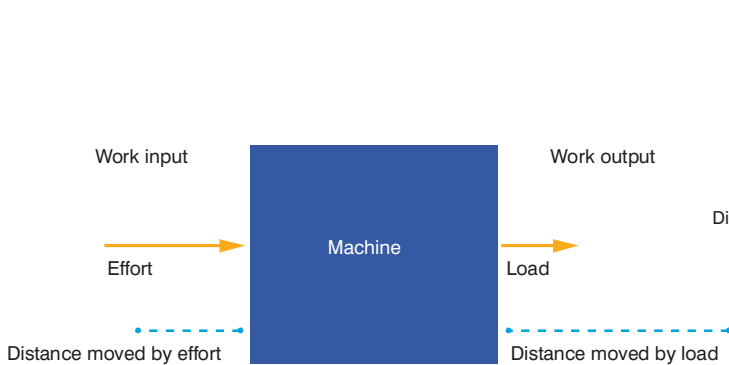
**Figure 5.5** A schematic of a force multiplier. Notice the load is greater than the effort but the distance moved is smaller.

### Speed multipliers

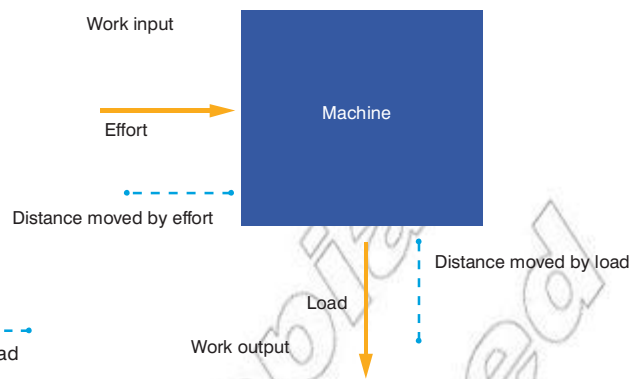
These are machines designed so that the *distance moved by the load is greater than the distance moved by the effort in the same time*. This is only possible if the load is a smaller force than the effort.

### DID YOU KNOW?

The famous ancient Greek philosopher Archimedes first came up with the idea of a simple machine around 250 BC. He listed three types of simple machine: lever, pulley and screw. It was not until the Renaissance when Galileo completed the list of all six. He was also the first to realise that simple machines do not create energy.



**Figure 5.6** A schematic of a speed multiplier. Notice the load is smaller than the effort but the distance moved is greater.



**Figure 5.7** A schematic of a direction changer. Notice the load is moved in a different direction to the effort.

### KEY WORDS

**direction changers machines** that move the load in a different direction to the effort

**mechanical advantage** the ratio between the load and the effort

**ratio** the size of quantities relative to each other

**velocity ratio** the ratio between the distance moved by the effort and the distance moved by the load

### Direction changers

These are machines designed so that the *load is moved in a different direction to the effort*.

Depending on how they are designed some machines can act as both force or speed multipliers *and* direction changers. However, a machine cannot multiply both the force and the speed at the same time; this would mean the work output would be greater than the work input.

### Mechanical advantage (MA) and velocity ratio (VR)

Some machines are more effective than others. One type of force multiplier might be able to move a 100 N load when 20 N of effort is applied. Another might be able to move a 500 N with the same effort.

It is not just a simple case of the greater the load that can be moved the better the machine, there are a number of other factors. However, there are two terms that are often used to compare different machines. These are **mechanical advantage (MA)** and **velocity ratio (VR)**.

### Mechanical advantage (AMA and IMA)

The term mechanical advantage refers to the **ratio** between the load and the effort. For example, if a machine moves a 400 N load when an effort of 100 N is applied the mechanical advantage is four. In other words you get 4× the force out of the machine. Mechanical advantage can be calculated using the following equation:

- **Mechanical advantage = load / effort**
- **MA = load / effort**

MA has no units since it is a ratio. If the MA is 1 this means that the effort equals the load. If the MA is two the load is twice the effort and if the MA is 0.5 the load is half the size of the effort.

Mechanical advantage is most frequently used to compare force multipliers. If the MA is *greater* than one the machine can be considered a force multiplier (as the load is greater than the effort).

There are actually two kinds of mechanical advantage; we have really been talking about **actual mechanical advantage** (AMA). This compares the force you get out (load) compared with what you put in (effort).

All machines also have an **ideal mechanical advantage** (IMA). This is the mechanical advantage if there were no other energy losses (e.g. no losses through friction, etc.). For most of our calculations and examples we will assume that there are no energy losses. In this case IMA = AMA and so there is no need to distinguish between the two. However, in the real world IMA is always greater than AMA.

### Velocity ratio (VR)

The term velocity ratio refers to the ratio between the distance moved by the effort and the distance moved by the load. For example, if an effort has to move 30 m in order to move a load 3 m then the velocity ratio is 3.

- **Velocity ratio = distance moved by effort / distance moved by load.**
- **VR = distance moved by effort / distance moved by load.**

Just like MA, VR has no units since it is a ratio. If the VR is 1 this means that the effort and the load both move the same distance. If the VR is 2 then the effort has to move twice as far as the load and if the VR is 0.5 then the load ends up moving twice as far as the effort.

### Activity 5.2: Velocity ratios

Complete the following table:

Distance moved by effort (m)	VR	Distance moved by load (m)
0.16	4	
0.5		1.5
2	0.5	
	0.1	1

If the VR is *less* than 1 the machine can be considered a speed multiplier (as the distance moved by the load is greater than the distance moved by the effort).

### Efficiency of machines

As discussed earlier, no machine can increase both the magnitude and the distance of a force at the same time. This would break the law of conservation of energy. When a machine provides an

### Activity 5.1: Mechanical advantage

Complete the following table:

Effort (N)	MA	Load (N)
500	2	
30		120
360	0.5	
	0.2	1000

### KEY WORDS

**actual mechanical advantage** *the ratio between the load and the effort taking into account energy losses due to friction etc*

**ideal mechanical advantage** *the ratio between the load and the effort, assuming no other energy losses*

### Think about this...

You will need to think carefully about what the VR number represents. You might think a VR of 3 means the load moves 3x further than the effort. This is not true! In fact the load will move a third of the distance (i.e. 1/3).

### Worked example

A simple machine provides a work output of 120 J for every 480 J of work input. Its efficiency would be given by:

$\eta = \text{work output} / \text{work input}$   
*State principle or equation to be used (definition of efficiency)*

$\eta = 120 \text{ J} / 480 \text{ J}$  *Substitute in known values and complete calculation*

- $\eta = 0.25$  (or 25%) *Clearly state the answer (either as a decimal or as a percentage)*

To find the work output if 2800 J of work goes into the machine we need to rearrange the equation:

$\eta = \text{work output} / \text{work input}$   
*State principle or equation to be used (definition of efficiency)*

$\text{work output} = \eta \times \text{work input}$   
*Rearrange equation to make work output the subject*

$\text{work output} = 0.25 \times 2800 \text{ J}$   
*Substitute in known values and complete calculation*

$\text{work output} = 700 \text{ J}$  *Clearly state the answer with unit*

We could then use our equations for work input and output to determine the effort and/or load if the other variables are known.

If the efficiency is one then this means the machine is 100% efficient; there are no energy losses and so the work output equals to the work input. Remember, no machine is ever 100% efficient.

**Figure 5.8** The efficiency of a machine increases as the load increases.

### Think about this...

Why can't the efficiency be greater than 1? What would this mean?

increase in force there must always be a decrease in the distance the force is moved. The reverse is also true; if a machine provides an increase in the distance the force moves then there will be a decrease in force (another way to think about this is that no machine can produce more work than the amount of work that is put into the machine).

The term **efficiency** (given the symbol  $\eta$ ) is the ratio between the work output and the work input. It is often then multiplied by 100 to give a percentage. The equation is as follows:

- **Efficiency = work output / work input**
- **$\eta = \text{work output} / \text{work input}$**

Just like MA and VR, efficiency has no units since it is a ratio.

If the efficiency of a machine is 0.8 (or 80 %) this means that you would get 80 J of work out for every 100 J you put in. If you put in 500 J you would get 400 J of work out.

We can also express efficiency in terms of MA and VR by expanding our equations for work output and work input:

- **Efficiency = work output / work input**
- **Efficiency = (load  $\times$  distance moved by load) / (effort  $\times$  distance moved by effort)**
- **load / effort = AMA**
- **distance moved by load / distance moved by effort = 1 / VR**

So

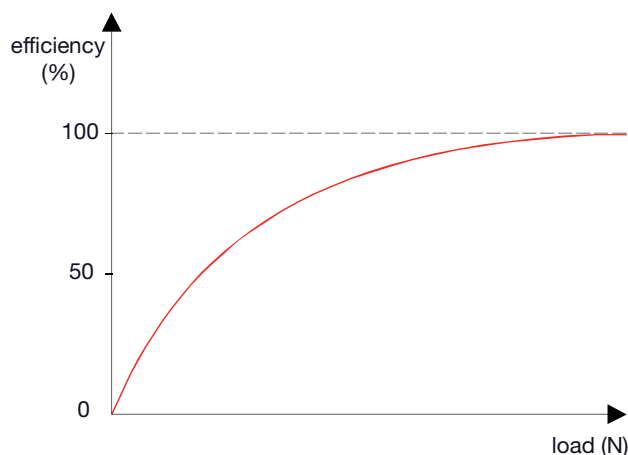
- **efficiency = AMA / VR**
- **$\eta = \text{AMA} / \text{VR}$**

So a machine with an MA of 6 and a VR of 8 has an efficiency of:

$\eta = \text{AMA} / \text{VR} = 6 / 8$  *Substitute in known values and complete calculation*

$\eta = 0.75$  (or 75%) *Clearly state the answer (either as a decimal or as a percentage)*

If  $\text{AMA} = \text{VR}$  then the machine would be 100 % efficient.



If the machine was 100% efficient then:

- $\eta = \text{AMA}/\text{VR} = 1$
- $\text{AMA} = \text{VR}$

In this case as there are no energy losses then the AMA would be equal to the IMA and so to calculate IMA we could use:

- $\text{AMA} = \text{IMA} = \text{VR}$
- $\text{IMA} = \text{distance moved by effort} / \text{distance moved by load}$

The VR is also equal to the maximum theoretical MA (IMA).

## Summary

In this section you have learnt that:

- A machine is a device that makes it easier to do mechanical work.
- There are six different types of simple machine: inclined plane, wedge, screw, lever, wheel and axle, and pulley.
- Machines can be classed as force multipliers/speed multipliers and/or direction changers.
- The force put into a machine is called the effort; this may be used to move a load.
- The work output from a machine is equal to the load  $\times$  the distance moved by the load.
- The work input to a machine is equal to effort  $\times$  distance moved by the effort.
- $\text{AMA} = \text{load} / \text{effort}$ .
- $\text{VR} = \text{distance moved by effort} / \text{distance moved by load}$ .
- $\eta = \text{MA}/\text{VR}$  can be derived from efficiency = work output / work input and the equations for MA and VR above.
- If the machine is 100% efficient then  $\text{VR} = \text{AMA} = \text{IMA}$ .

## Review questions

1. List the six kinds of simple machine.
2. Define the terms: effort, load, work input, work output, AMA, VR, efficiency and IMA.
3. A simple machine is able to move a 400 N load a distance of 20 cm when a force of 20 N is moved through a distance of 5.0 m. Calculate:
  - a) the work input
  - b) the work output
  - c) the actual mechanical advantage

## Worked example

The following information was collected from a simple machine.

Effort = 300 N, load = 1200 N, distance moved by effort = 15 cm, distance moved by load = 3 cm.

$\eta = \text{AMA}/\text{VR}$  *State principle or equation to be used (definition of efficiency in terms of AMA and VR)*

$\text{AMA} = \text{load} / \text{effort} = 1200 \text{ N} / 300 \text{ N} = 4$  *Substitute in known values and complete calculation*

$\text{AMA} = 4$  *Clearly state the answer*

$\text{VR} = \text{distance moved by effort} / \text{distance moved by load} = 0.15 \text{ m} / 0.03 \text{ m} = 5$  *Substitute in known values and complete calculation*

$\text{VR} = 5$  *Clearly state the answer*

$\eta = \text{AMA}/\text{VR}$  *State principle or equation to be used (definition of efficiency in terms of AMA and VR)*

$\eta = 4 / 5$  *Substitute in known values and complete calculation*

$\eta = 0.8$  (or 80%) *Clearly state the answer (either as a decimal or as a percentage)*

The efficiency of a particular machine depends on a number of different factors. However, it is always true that as the load increases the efficiency of the machine will also increase.

## KEY WORDS

**efficiency** *the ratio between the work output and the work input*

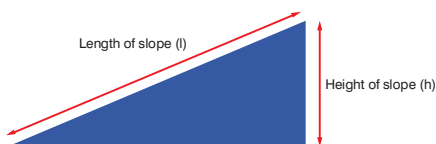


- d) the velocity ratio
  - e) the efficiency of the machine
  - f) the ideal mechanical advantage.
4. A simple machine has an efficiency of 0.75 and a VR of 12. Determine the MA and the load that can be moved if an effort of 100 N is applied.

## 5.2 Inclined plane, wedge and screw

By the end of this section you should be able to:

- Derive an expression for MA of an inclined plane with or without friction.
- Calculate MA, VR and efficiency of an inclined plane.
- Calculate MA, VR and efficiency of a wedge.



**Figure 5.9** A simple inclined plane

### The inclined plane

An inclined plane is just another name for a ramp. The object is lifted to a height ( $h$ ) by sliding it up the length of the slope ( $l$ ).

You probably know from experience that it is easier push a heavy object up a ramp than it is to lift it to the same height. This is because inclined planes reduce the force necessary to move a load. In other words, the effort required is less. However, the amount of work done must stay the same so the distance involved increases.

The actual mechanical advantage can be found using the standard equation:

- **AMA = load / effort**

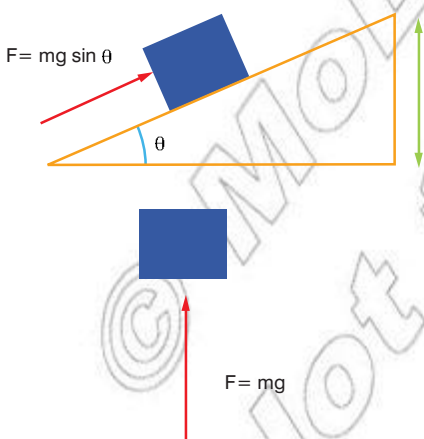
In the case of the inclined plane the load would be the weight of the object and the effort would be to force required to push it up the slope.

Assuming there is no friction the force required to push the object up the ramp is equal to  $mg \sin \theta$ . As the angle of the slope increases  $\sin \theta$  gets bigger; at  $90^\circ$  it equals one and so then the force required equals  $mg$ . In other words, the shallower the slope the lower the force required; however, you would have to push the object a much greater distance to raise it to the same height.

We can derive an expression for mechanical advantage using the dimensions of the inclined plane:

- **Work output =  $F s = \text{load} \times h$**
- **Work input =  $F s = \text{effort} \times l$**

If there are no energy losses (i.e. there is no friction), then **work output = work input**, so:



**Figure 5.10** Force required to move an object up a ramp vs. lifting it vertically

- $\text{load} \times h = \text{effort} \times l$
- $\text{load} / \text{effort} = l / h$
- $\text{load} / \text{effort} = \text{MA}$
- $\text{MA} = l / h$

This is really the IMA as we have had to assume that there are no energy losses due to friction. Remember, the IMA is also equal to the VR so the VR for an inclined plane:

- $\text{VR} = \text{IMA} = l / h$

The gentler the slope, the greater the ratio of the length of its slope to its height. Therefore, the greater the IMA.

The inclined plane can be thought of as a force multiplier and direction changer.

### Activity 5.3: Inclined planes

Calculate the VR (and so the IMA) for the following:

1. A slope of length 20 m that rises to a height of 5 m.
2. A slope of length 100 m that rises to the same height.
3. A slope that is at an angle of  $30^\circ$  to the horizontal and rises to a height of 50 m.

In reality, when you push an object up a slope you need to apply an effort greater than  $mgsin \theta$  as you also need to overcome the force due to friction. The force required would equal  $mgsin \theta$  + force due to friction. Therefore the actual mechanical advantage may be found using the following equation:

- $\text{AMA} = \text{load} / \text{effort}$
- $\text{effort} = mgsin \theta + \text{frictional force}$
- $\text{load} = mg$
- $\text{AMA} = mg / (mgsin \theta + \text{frictional force})$

The efficiency of an inclined plane can be determined using the standard efficiency equation just applied to inclined planes:

- $\eta = \text{work output} / \text{work input} = \text{load} \times h / \text{effort} \times l$

Or, in terms of AMA and VR:

- $\eta = \text{AMA} / \text{VR}$
- $\text{AMA} = mg / (mgsin \theta + \text{frictional force})$  and  $\text{VR} = l / h$
- $\eta = mgh / (mgsin \theta + \text{frictional force})l$

### The wedge

A **wedge** is our second type of simple machine. Wedges are used to separate two objects or split objects apart. Examples of wedges include knives, forks, nails, spears, axes and arrows heads.



**Figure 5.11** The ancient Egyptians used inclines to help in the construction of the great pyramids.

### Think about this...

$mgh$  is the useful work output, whereas  $(mgsin \theta + \text{frictional force})l$  is the work input. Think about this as work done in lifting the object + work done against friction.

### Activity 5.4: Including friction

A slope of length 50 m rises to a height of 10 m above the ground. An effort of 100 N is needed to push a 250 N object up the ramp. Calculate:

1. AMA
2. VR
3. efficiency

### KEY WORDS

**wedge** a piece of material, such as metal or wood, thick at one edge and tapered to a thin edge at the other

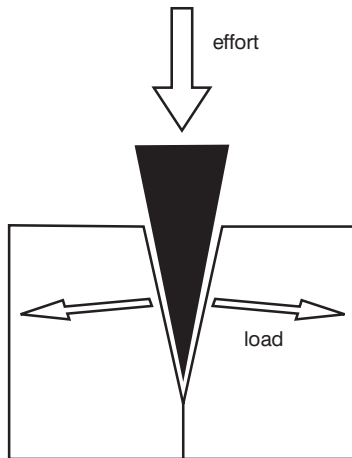


Figure 5.12 A simple wedge

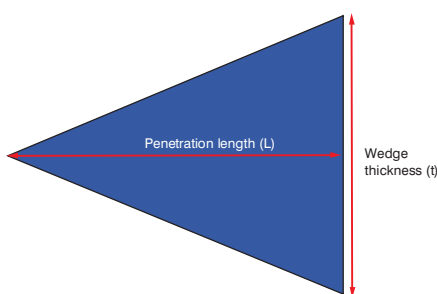


Figure 5.13 Characteristics of a wedge

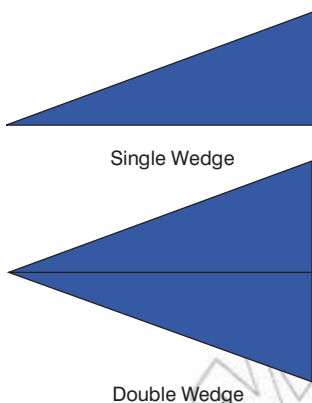


Figure 5.14 A single or double wedge

**DID YOU KNOW?**

The origin of the wedge is unknown, probably because it has been in use for over 9000 years. In ancient Egyptian quarries, bronze wedges were used to break away blocks of stone used in construction.

A wedge can either be composed of one or two inclined planes. A double wedge can be thought of as two inclined planes joined together with their sloping surfaces outward.

There are two major differences between inclined planes and wedges. Firstly, when in use an inclined plane remains stationary, whereas the wedge moves. Secondly, the effort is applied parallel to the slope of an inclined plane. When using a wedge the effort is applied to the top of the wedge.

The actual mechanical advantage can be found using the standard equation:

- $AMA = \text{load} / \text{effort}$

In this case the load would be the force exerted on the object being split and the effort would be the force applied to the top of the wedge.

Just like we did with inclined planes we can derive an expression for mechanical advantage using the dimensions of the wedge:

- $\text{Work output} = F s = \text{load} \times t$
- $\text{Work input} = F s = \text{effort} \times L$

If there are no energy losses (i.e. there is no friction), then **work output = work input**, so:

- $\text{load} \times t = \text{effort} \times L$
- $\text{load} / \text{effort} = L / t$
- $\text{load} / \text{effort} = MA$
- $MA = L / t$

This is really the IMA as we have had to assume that there are no energy losses due to friction. Remember, the IMA is also equal to the VR so the VR for a wedge =  $L / t$ .

- $VR = IMA = L / t$

The more narrow the wedge, the greater the ratio of the length of its slope to its width. Therefore, the greater the IMA.

Like inclined planes, wedges can be thought of as force multipliers and direction changers.

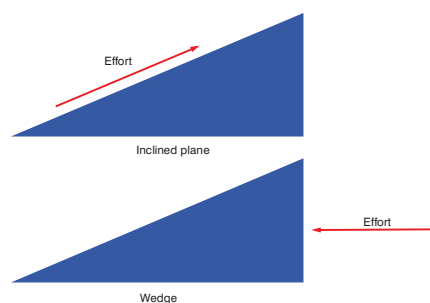


Figure 5.15 Differences between a wedge and an inclined plane

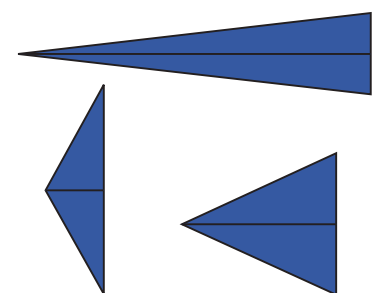


Figure 5.16 Three different wedges: which offers the greatest IMA?

The efficiency of a wedge can be determined using the standard efficiency equation just applied to wedges:

- $\eta = \text{work output} / \text{work input} = \text{load} \times t / \text{effort} \times L$

## The screw

The term **screw** really refers to any cylinder with a helical thread around it. This means it includes nuts and bolts as well as more traditional screws. The screw is a very useful machine; it can be used to hold objects together, to dig into the ground and to bore through rocks.

You can think of a screw as like an inclined plane wrapped around a cylinder. In one turn of the screw it digs in and moves into the material a distance equal to the separation between the threads. This is referred to as the pitch ( $P$ ) of the screw and it is analogous to the height of an inclined plane. If you could unravel a screw thread for each rotation you could see it moves up a distance equal to  $P$ . The length of the slope would be the same as the circumference of the screw shaft.

The movement of the screw tip into the material provides the load, whereas the force used to turn the screw is the effort.

The maximum theoretical mechanical advantage (IMA) for a screw can be calculated using the following equation:

- $IMA = \pi d / P$

$d$  = the mean diameter of the screw shaft in m ( $\pi d$  is the circumference of the screw shaft).

$P$  = the pitch of the screw in m.

There is always a great deal of friction when using screws and the actual mechanical advantage is much less than the value calculated using the equation above. However, it is also worth noting mechanical advantage of a screw system is increased as the screwdriver (or other method for turning the screw) produces its own mechanical advantage.

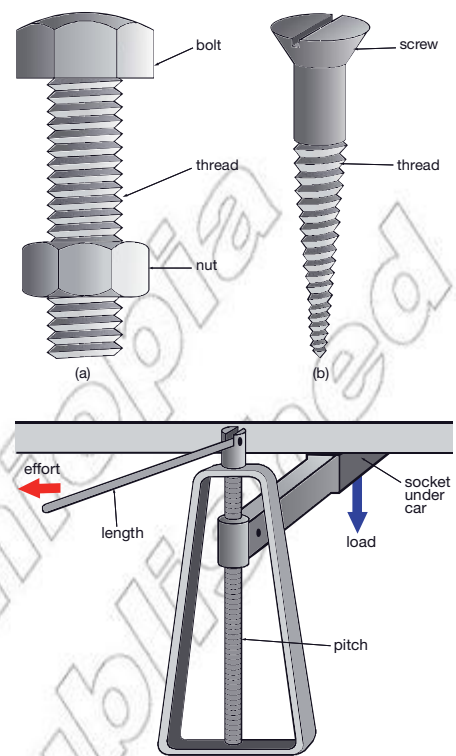


Figure 5.17 Examples of screws

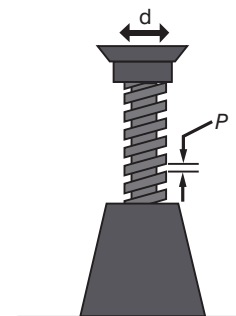


Figure 5.18 Screw characteristics



Figure 5.19 Screw threads

### KEY WORDS

**screw** a cylinder of material with a helical thread around it

## Summary

In this section you have learnt that:

- For an inclined plane the AMA = load / effort, where the load = the weight of the object and the effort = the force required to push the object up the slope ( $mgs \sin \theta + \text{frictional forces}$ ).
- If we assume there is no friction on an inclined plane then  $VR = IMA = \text{length of the slope } (l) / \text{height of the slope } (h)$ .
- For a wedge the AMA = load / effort, where the load = the force applied to the object being split apart and the effort = the force applied to top surface of the wedge.
- If we assume there is no friction on the wedge then  $VR = IMA = \text{penetration length } (L) / \text{wedge thickness } (t)$ .

### Think about this...

The equation for the screw shows how similar a screw and an inclined plane are.  $\pi d$  is equivalent to  $l$  and  $P$  is equivalent to  $h$ . MA for the inclined plane =  $l/h$  and for the screw =  $\pi d/P$ .

### DID YOU KNOW?

Some say there are only five different types of simple machine. They argue that the wedge is just a moving inclined plane. Others say that the screw is just a helical inclined plane; this reduces the list to four!

### Review questions

- For an inclined plane derive  $\eta = l/h$ .
- A block of weight 5000 N is pushed up a slope by a force of 250 N. Assume there is no friction. Calculate:
  - the actual mechanical advantage
  - the velocity ratio
  - the length of the slope if the height of the slope is 10 m.
- An inclined plane is 100 m long and at an angle of  $20^\circ$  to the horizontal. The AMA of the slope is two. Calculate:
  - the effort required to push a 7200 N block up the slope
  - the ideal mechanical advantage
  - the efficiency of the slope.
- Describe the differences between a wedge and an inclined plane.

### 5.3 Levers

By the end of this section you should be able to:

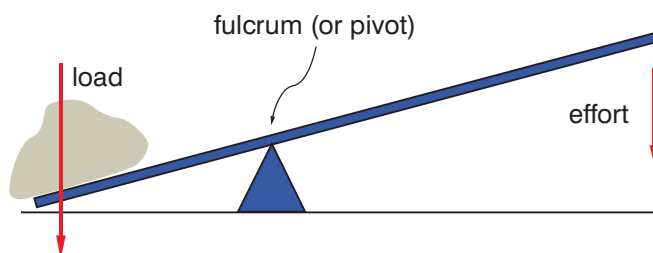
- Determine the MA, VR and efficiency of a lever.
- Identify the orders of a lever and give examples.
- Describe the use of a wheel and axle and determine MA, VR and efficiency of a wheel and axle.
- Describe the use of gears.
- Describe different pulley systems and calculate MA, VR and efficiency of a pulley system.
- Describe the use of a jackscrew.

### Using levers

A simple **lever** is just a bar that is free to turn around a fixed point. This fixed point is called the **fulcrum** (sometimes the pivot).

### KEY WORDS

**fulcrum** *the pivot of a lever*  
**lever** *a bar which is free to turn around a fixed point*



**Figure 5.20** Key features of a simple lever

Unlike our earlier simple machines levers involve twisting and turning forces.

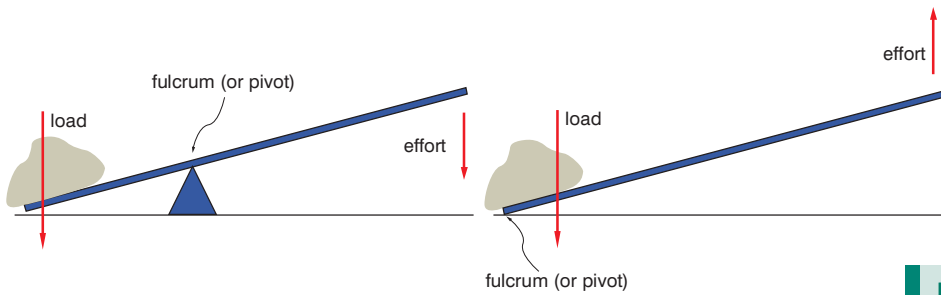


Figure 5.21 Two different ways to use a lever to lift a load

### MA, VR and efficiency of levers

When dealing with levers the forces are twisting rather than moving in a straight line. As a result we need to think carefully about MA and VR. Let's take a simple example of a balanced see-saw.

In order to balance the turning forces (moments) from both the objects must be equal. The forces might be different but their turning effects must be the same (more on this in Grade 10). In order for an object to balance:

- anticlockwise turning force = clockwise turning force

So in the example below:

- $F_1 \times d_1 = F_2 \times d_2$

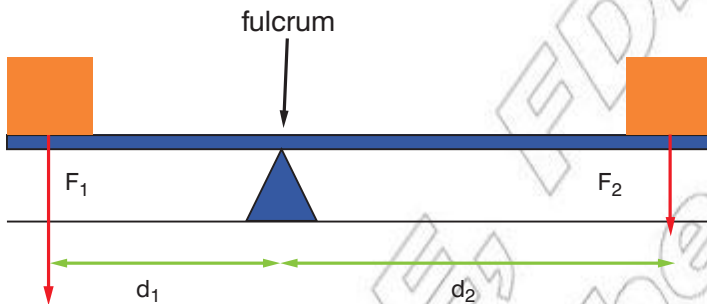


Figure 5.22 A simple balanced lever

If  $F_1$  is twice as large as  $F_2$  then  $F_2$  will need to be twice as far away from the fulcrum in order for the see-saw to balance. The **product** of the force and distance for both the left hand side and the right hand side must be equal.

For example, you can balance a 10 N rock with a 0.01 N feather. The feather would need to be 1000 times further from the fulcrum than the rock.

This principle can be applied in terms of load and effort. Imagine the feather was the effort and the rock was the load. The lever has acted like a **force multiplier** with a 0.01 N input force and 10 N output force. Remember, in order for this to be true the effort needs to be applied 1000 times further away from the fulcrum than the load. This leads to the following equation:

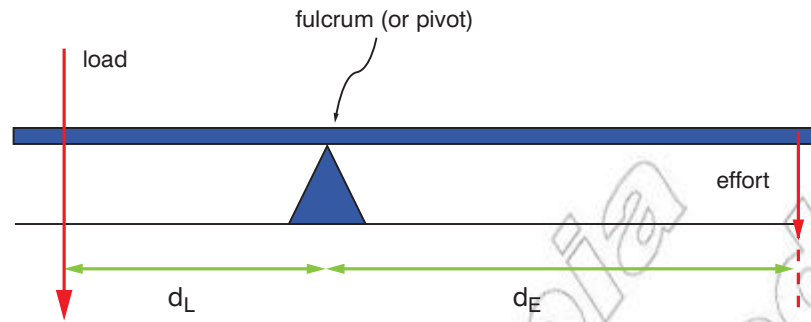
- $\text{load} \times d_L = \text{effort} \times d_E$

### DID YOU KNOW?

The term lever originates in France; 'levier' means to "to raise".

### KEY WORDS

**product** the result of multiplying two values



**Figure 5.23** The key factors affecting the MA and VR of a lever

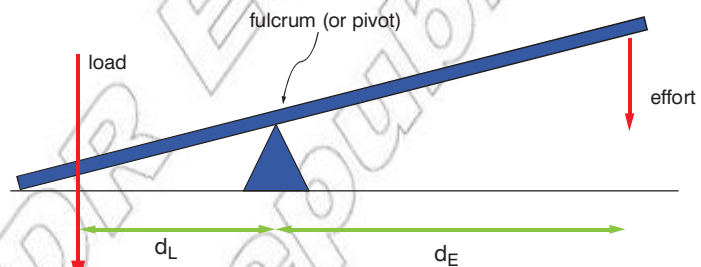
It is important to notice that the distances used are always **perpendicular** to the forces. The greater the ratio of  $d_E$  to  $d_L$  the greater the mechanical advantage (the greater the load you can lift for the same effort). Longer levers make it much easier to lift heavier loads. If you had a really long lever you could lift almost anything (see Did you know?).

### Think about this...

The distances to the fulcrum must always be perpendicular to the forces.

### DID YOU KNOW?

Archimedes did not invent the lever; instead he wrote the first known explanation of the principles involved. According to Pappus of Alexandria and referring to the MA offered by levers, Archimedes once said: “Give me a place to stand on, and I will move the Earth.”



**Figure 5.24** Distances perpendicular to forces

The actual mechanical advantage of the lever is given by the standard equation for MA:

- $AMA = \text{load} / \text{effort}$

However, the equation for VR for levers is a little different. As the system is rotating we do not use the distance moved by the force. Instead we use the distances from the fulcrum. The VR can be found as the ratio between the distance from the effort to the fulcrum and the distance from the load from the fulcrum.

- $VR = \text{distance from the effort to the fulcrum} / \text{distance from the load from the fulcrum}$ .
- $VR = d_E / d_L$

If there are no energy losses then  $IMA = VR$  and so:

- $IMA = d_E / d_L$

The efficiency of a given lever maybe found via:

- $\text{efficiency} = \eta = \text{load} \times d_L / \text{effort} \times d_E$

(In terms of MA and VR,  $\eta = AMA/VR$ ).

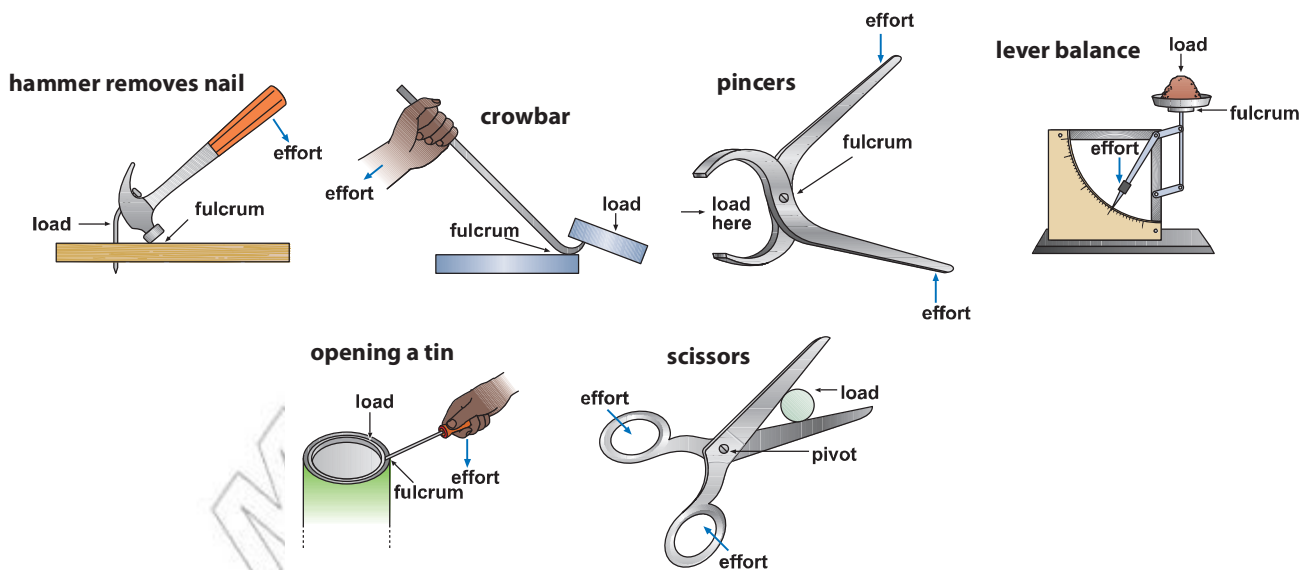
Depending on the relative distances levers can be force multipliers/speed multipliers and/or direction changers.

## Different classes of lever

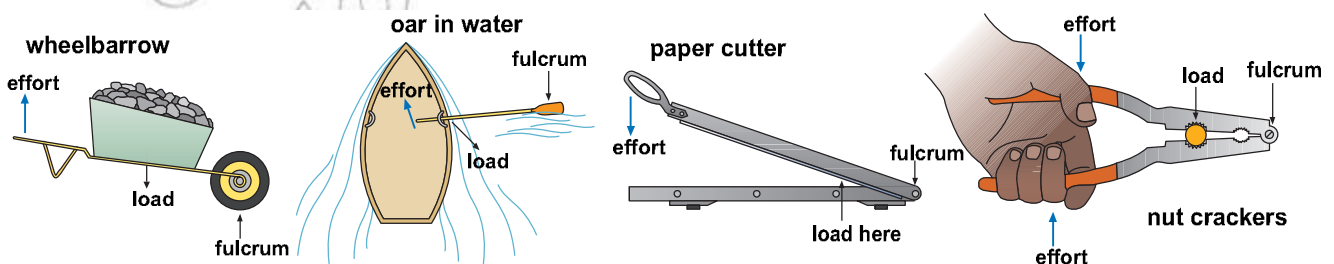
There are *three* different classes of levers depending on the relative positions of the **load**, **fulcrum** and **effort**.

**Table 5.1** Different classes of levers

Class	Diagram	Description	Examples
1 <sup>st</sup>		Fulcrum is between the load and effort	<ul style="list-style-type: none"> <li>• See-saw</li> <li>• Crowbar</li> <li>• Pliers (double lever)</li> <li>• Scissors (double lever)</li> </ul>
2 <sup>nd</sup>		The load is between the effort and the fulcrum	<ul style="list-style-type: none"> <li>• Wheelbarrow</li> <li>• A rowing oar</li> <li>• Nutcracker (double lever)</li> </ul>
3 <sup>rd</sup>		The effort is between the load and fulcrum	<ul style="list-style-type: none"> <li>• Catapult</li> <li>• Hoe or spade</li> <li>• Tongs (double lever)</li> </ul>



**Figure 5.25** First-class levers have their fulcrum between load and effort. Pincers and scissors are double levers.



**Figure 5.26** Second-class levers: load between effort and fulcrum



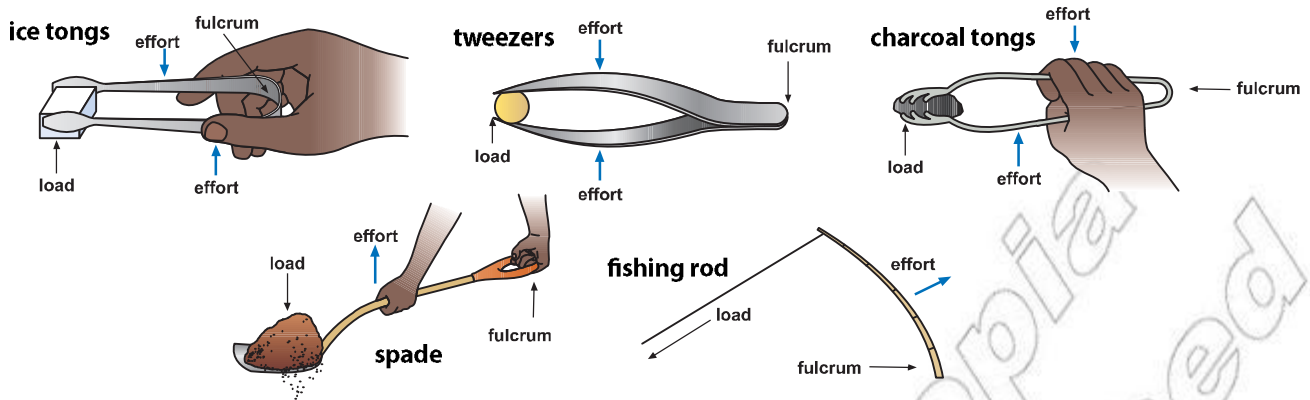


Figure 5.27 Third-class levers: effort between load and fulcrum

### Lever in the body

Examples of the three classes of lever occur in the body:

Table 5.2 Levers in the body

	Fulcrum	Load	Muscle providing effort
Head	Joint between head and backbone	Head	Muscle at back of neck
Foot	Toes	Body	Calf muscle (back of leg)
Arm	Elbow	Arm	Biceps muscle (upper arm)

**Activity 5.5: Demonstrating levers**

- Use a metre rule, a known weight as the load, and a spring balance as the effort in order to demonstrate the three classes of lever.
- Use cardboard to make a simple label for the fulcrum.
- Make arrows to label the load and effort.

### The wheel and axle

The wheel and axle is another type of simple machine; it is comprised of a large wheel secured to a smaller wheel, which is called an axle. Wheels and axles do not just include the obvious; they also include gears, door-knobs, steering wheels and even screwdrivers!

There are two main ways to use a wheel and axle. The first way can be seen in Figure 5.28. You can wrap a rope around a supported wheel and apply an effort to the end of the rope. This causes the wheel and attached axle to rotate. If a load is attached to the axle as it turns it lifts the load. The effort has to move a long way to complete one single revolution (as the diameter of the wheel is large). The load moves a much smaller distance as the axle has a much smaller diameter. This means the load can be much greater than the effort and so there is a mechanical advantage.

The second way to use a wheel and axle is to have two wheels at the end of an axle. The wheel and axle then behaves like a type of rotating lever. In this case the fulcrum would be the centre point of the axle. As the wheels turn they can then be used to provide movement.

The mechanical advantage of a wheel and axle may be calculated using the standard equation for AMA:

- $AMA = \text{load} / \text{effort}$

The VR of the wheel and axle is the ratio of the radius of the wheel to the radius of the axle. This is because as the wheel turns once it

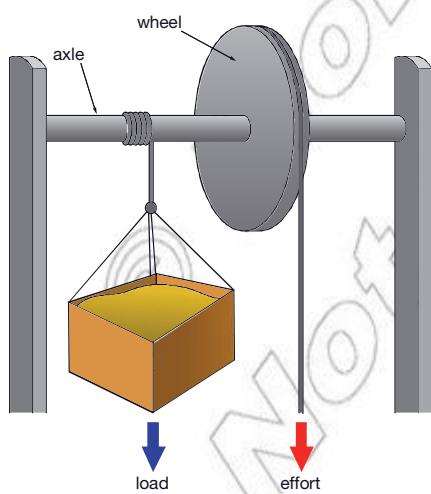


Figure 5.28 A wheel and axle

covers a distance equal to  $2\pi R$ ; in the same time the axle travels  $2\pi r$ . So the VR is given by:

- $\text{VR} = \text{distance moved by effort} / \text{distance moved by load}$
- $\text{VR} = 2\pi R / 2\pi r$
- $\text{VR} = R / r$

If the machine was 100% efficient then  $\text{VR} = \text{MA} = \text{IMA}$  so:

- $\text{IMA} = \text{VR}$
- $\text{IMA} = R / r$

If the radius of the wheel is ten times greater than the radius of the axle, every time you turn the wheel once, the force will be multiplied by ten but it will also travel ten times the distance.

Depending on the relative radii wheels and axles can be thought of as force multipliers/speed multipliers and/or direction changers.



**Figure 5.29** An example of a wheel and axle

### The effect of gears

**Gears** are often used in conjunction with a wheel and axle. They can be configured to offer an increase in mechanical advantage or an increase in the distance travelled, depending on the requirements of the system.

As one gear turns its teeth lock into another gear and force it to rotate. The gear made to turn is called the driving gear or occasionally the pinion (the one where the effort is applied). As the driving gear then rotates it turns the driven gear.

The VR of a pair of gears is given by the ratio of the number of their teeth.

- $\text{VR} = \text{number of teeth on driven wheel} / \text{number of teeth on driving wheel}$
- $\text{VR} = N_{\text{driven}} / N_{\text{driving}}$

This is also called the **gear ratio**. If the gear ratio was 0.5 then the driven gear would rotate once for every two rotations of the driving gear.

Looking at Figure 5.31, if the left hand wheel was the driving wheel then there would be a VR of less than one. In other words the distance would increase but the effort would have to be greater than the load.

If the driving wheel was the one on the right then the opposite would be true. The load would be greater than the effort but it would not travel as far.

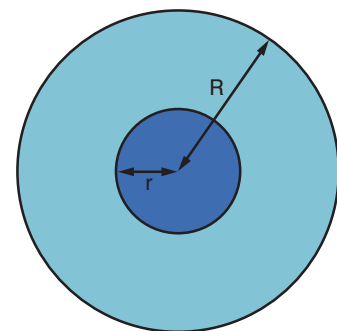
If the machine was 100% efficient then  $\text{VR} = \text{MA} = \text{IMA}$  so:

- $\text{IMA} = \text{VR}$
- $\text{IMA} = N_{\text{driven}} / N_{\text{driving}}$

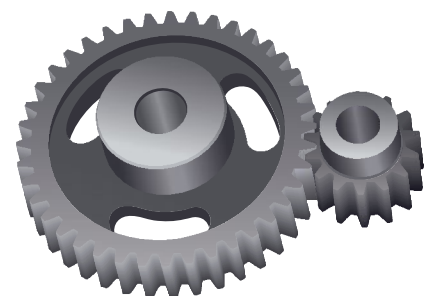
Two or more gears together are called a **transmission**. Depending on the gear ratio, transmissions can produce a change the speed, magnitude and direction of a force.

### DID YOU KNOW?

It is probably fair to say that the wheel is the most important invention of all time. The oldest wheel was found in Mesopotamia (modern Iraq/Syria). It is believed to be over 5000 years old.



**Figure 5.30** The radii of the wheel and axle are the two factors that determine the VR.



**Figure 5.31** A simple example of a pair of gear wheels



Figure 5.32 A rack and pinion

**DID YOU KNOW?**

The most common application of gears involves one gear causing another to rotate. However, in a rack and pinion a gear causes a linear toothed track (called a rack) to move. This leads to a movement in a straight line rather than a rotation.

**Pulley systems**

There are several different kinds of **pulley**. The most simple comprises a fixed axle with a rope looped over the top (called a class 1 or **fixed pulley**). Even if there was no friction, a fixed pulley will not provide more than a mechanical advantage of 1. This means there is no multiplication of force; instead the pulley just changes the direction of the force.

The second type of pulley is often called a **movable pulley**. Here the axle is free to move up and down.

If one end of the rope is fixed then applying an effort to the other end of the rope (after it has been looped around the pulley) will effectively provide about two times the force. However, it is worth noting that you have to provide additional effort to lift the movable pulley as well as the load.

A movable pulley has a VR of 2 as you would have to pull 2 m of rope through the pulley in order for it to lift the load 1 m. If there are no energy losses in the pulley then the  $VR = MA = IMA$ . Therefore the IMA for a movable pulley is also 2.

For both a fixed and a movable pulley there will be energy losses due to friction. As a result the MA will always be less than the VR.

A **compound pulley** is a combination of a fixed and a movable pulley. This is sometimes called a block and tackle. The movable pulley provides the MA whereas the fixed pulley changes the direction of the force. This makes it easy to lift the load when standing on the floor!

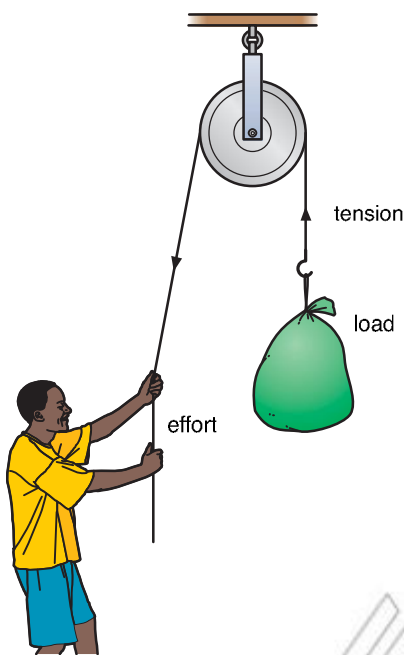


Figure 5.33 Using a pulley to lift a load

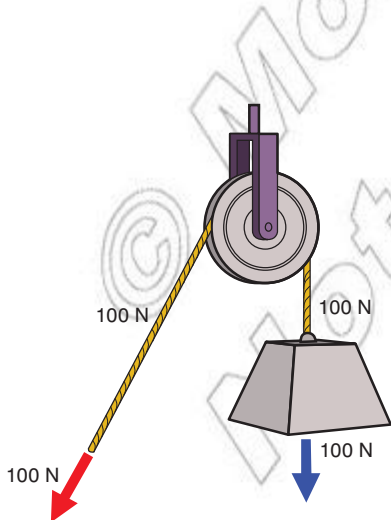


Figure 5.34 A fixed pulley offers no MA but does change the direction of the force.

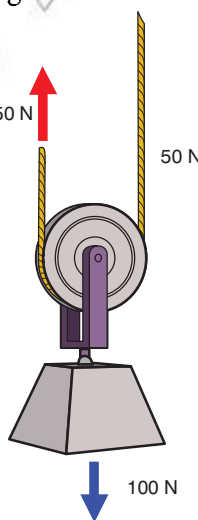


Figure 5.35 A movable pulley does provide an MA.

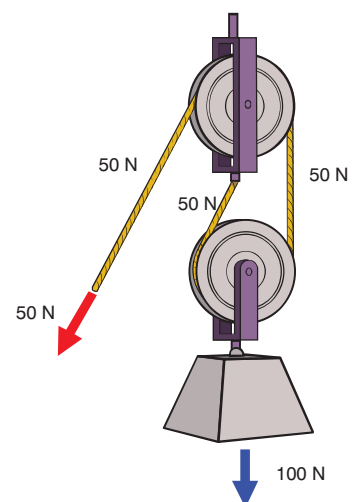


Figure 5.36 A compound pulley is a combination of a fixed and movable pulley.

To increase the VR of any block and tackle, a pulley block with more than one pulley in each block can be used. A long length of rope is tied to the top block then passes around each of the pulleys in turn.

The pulleys might be side by side (as in Figure 5.37) or above each other, as shown in the diagram in Figure 5.38.

The VR of these systems is given by the number ( $N$ ) of sections of rope used to lift the load. If there is only one section then  $VR = 1$ , if there are two sections then the  $VR = 2$ , etc.

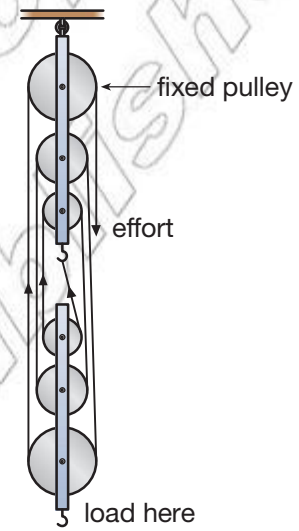
- **VR = number of sections of rope that lift the load**
- **VR =  $N$**

These systems are never 100% efficient since there is friction on the pulley and some of the effort is used to lift the lower block instead of the load. If the machine was 100% efficient then  $VR = MA = IMA$  so:

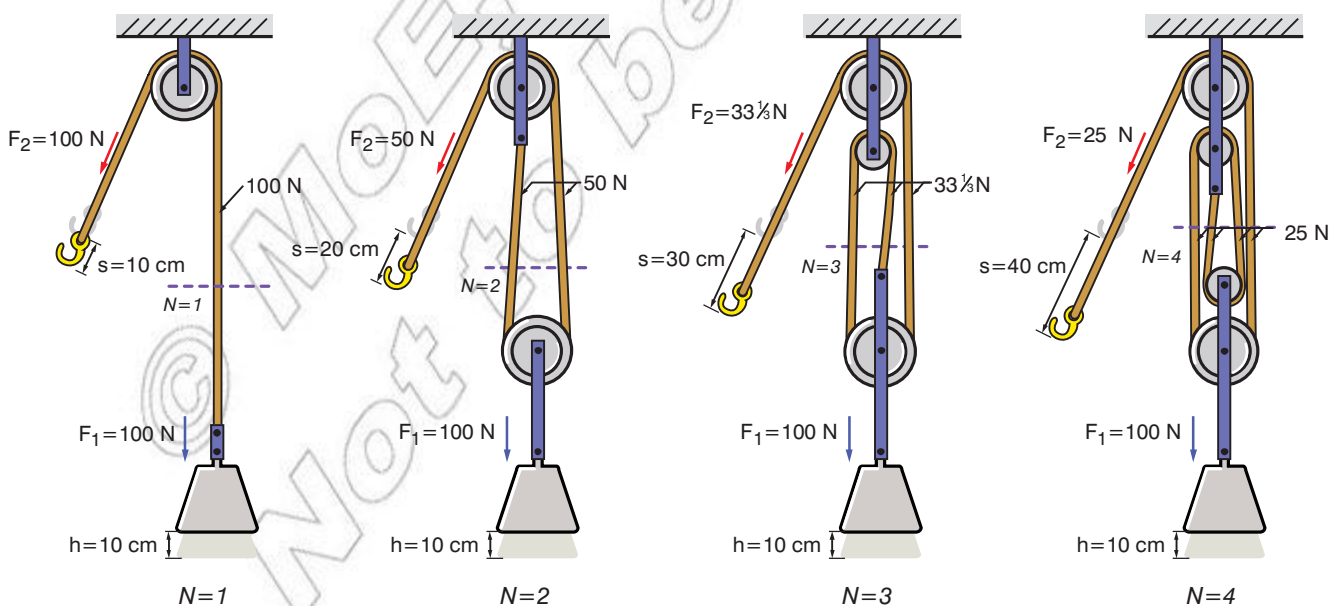
- **IMA = VR**
- **IMA =  $N$**



**Figure 5.37** A pulley block with three pulleys



**Figure 5.38** Two pulley blocks with three pulleys in each



**Figure 5.39** The VR of a pulley system depends on the number of sections of rope that lift the load.

**Think about this...**

What advantages and disadvantages are there to changing the diameter of the pulleys wheels, as shown in Figure 5.38? Hint: think about the IMA offered by a wheel and axle.

**KEY WORDS**

**fixed pulley** a grooved wheel on a fixed axle with a rope looped over it

**movable pulley** a grooved wheel on a movable axle with a rope looped round it

**pulley** a simple machine comprising a wheel with a grooved rim over which a rope or chain is passed

**transmission** a set of two or more gears

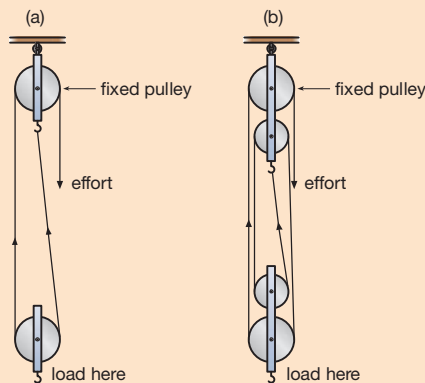
**complex machine** a device where two or more simple machines are combined to make a single mechanism

**differential pulley** a pulley combined with a wheel and axle

**jackscrew** a screw combined with a lever

**Activity 5.6: Investigating a system of pulleys**

- Arrange the pulley blocks as shown in Figure 5.40. Attach a forcemeter to measure the effort. Place a known weight on the lower block. Pull the forcemeter downwards so that the load rises slowly at a uniform speed. Note the steady reading. Repeat and take the average reading. Table 5.3 shows how to record your results.



**Figure 5.40** Using (a) two, and (b) four pulleys to raise a load

- Return the load to its low original position. Note the position on the rule of the load and the hook of the forcemeter (the effort). Raise the load a known distance. Measure how far the effort moves. Repeat and take the average reading.
- Calculate MA, VR and the efficiency.
- Repeat, using different weights as the load.

**Table 5.3** Investigating a system of four pulleys.

Load	Effort	MA	Distance moved by load	Distance moved by effort	VR	Efficiency
3 N	1.5 N	2.0	10 cm	40 cm	4	50%
5 N	2.0 N	2.5	12 cm	48 cm	4	62.5%
etc.						

The table shows results for a system of four pulleys. The mechanical advantage is less than four and the velocity ratio is exactly four (it is equal to the number of strings holding the load).

**More complex machines**

A **complex machine** is one where two or more simple machines are combined to function as a single mechanism. Examples include scissors, wheelbarrows, bicycles, the differential pulley and the jackscrew. We will look at two examples in more detail, the differential pulley and the jackscrew.

## The differential pulley

A **differential pulley** is a pulley in combination with a wheel and axle. It is sometimes called a “chain hoist” and it can be used to lift extremely large masses over a short distance.

It is composed of two fixed pulleys at the top. These are attached to each other and both rotate together. However, they have different radii ( $R$  and  $r$ ). One long loop of rope (or more commonly a chain) passes around the pulleys. The excess hangs off the pulley in a loop. To lift a load you pull on the loop, causing the pulleys to rotate and slowly lift the load. The mechanical advantage is calculated using the standard equation:

- $AMA = \text{load} / \text{effort}$

In this case the load =  $W$  and the effort =  $F$  so:

- $AMA = W / F$

The VR (and so the IMA) is given by:

- $VR = IMA = 2R / (R - r)$

As  $R - r$  approaches zero the IMA increases. If  $R$  is about the same as  $r$  it almost gets to the stage where the weight looks like it is no longer lifting as you end up pulling long lengths of chain or rope downward for a very small vertical movement. However, you are able to lift very heavy loads.

## The jackscrew

A **jackscrew** is a screw in combination with a lever. The MA from the lever allows large weights to be lifted by the screw.

The mechanical advantage is calculated using the standard equation:

- $AMA = \text{load} / \text{effort}$

In this case the load =  $W$  and the effort =  $F$  (the force applied at the end of the lever) so:

- $AMA = W / F$

The VR (and so the IMA) is given by:

- $IMA = VR = 2\pi R / P$

The longer the handle ( $R$ ) and the smaller the pitch ( $P$ ) the greater the IMA, but it would take even more turns in order to lift the car!

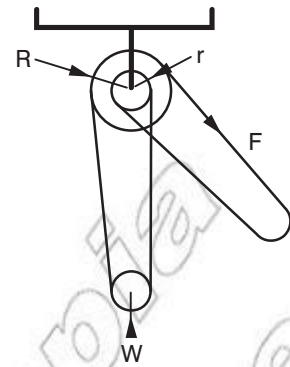


Figure 5.41 The key features of a differential pulley

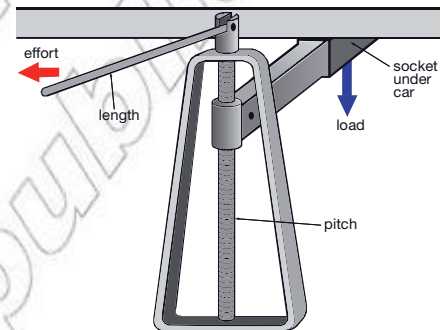


Figure 5.42 A simple jackscrew used as a car jack

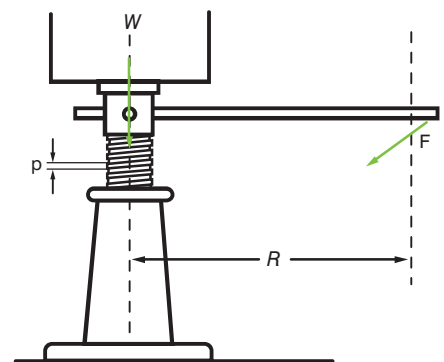


Figure 5.43 The key features of a jackscrew

## Summary

In this section you have learnt that:

- For a lever the  $AMA = \text{load} / \text{effort}$  and the VR (and so IMA) = distance of the effort to the fulcrum ( $d_E$ ) / distance of the load from the fulcrum ( $d_L$ ).
- There are three orders of levers, depending on the relative positions of the load, fulcrum and effort.

- For a wheel and axle the AMA = load / effort and the VR (and so IMA) = radius of wheel ( $R$ ) / radius of axle ( $r$ ).
- There are three different types of pulley systems: fixed, movable and compound.
- For a pulley the AMA = load / effort and the VR (and so IMA) = the number ( $N$ ) of sections of rope used to lift the load.
- A complex machine is a combination of two or more simple machines (for example, a jackscrew is a combination of screw and lever – this can be used to lift very heavy loads).

### Review questions

1. Explain how a lever can act as a force multiplier.
2. For the following simple see-saw calculate:
  - a) the load that could be lifted
  - b) the mechanical advantage (assume the lever is 100% efficient).

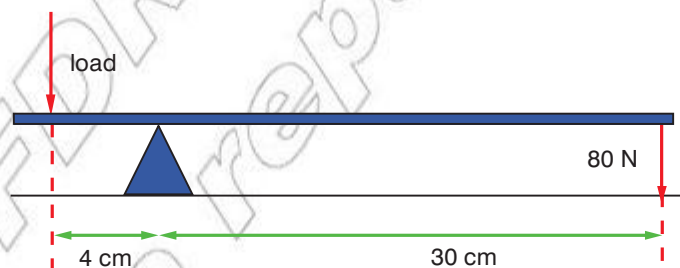


Figure 5.44 A simple see-saw

3. A simple wheel and axle is used to lift a bucket of water out of a well. The radii of the wheel and axle are 20 cm and 4 cm, respectively. Determine:
  - a) the velocity ratio (and so the IMA)
  - b) the theoretical effort required to lift a load of 30 N assuming no energy losses
  - c) the efficiency if the actual effort required is 10 N.
4. Describe the three different types of pulley.

### End of unit questions

1. Explain why for every simple machine the actual mechanical advantage is less than the ideal mechanical advantage.
2. By giving an example of a simple machine (including its dimensions) explain what is meant by force multiplier, speed multiplier and direction changer.

3. An inclined plane rises to a height of 2 m over a distance of 6 m. Calculate:
  - a) the angle of the slope
  - b) the VR (and so IMA) of the inclined plane
  - c) the theoretical force required to push an object with a mass of 200 kg up the slope.
4. Give three examples of wedges.
5. A 10 cm long, 2 cm wide wooden wedge is pushed into a soft wood block. Calculate:
  - a) the velocity ratio of the wedge
  - b) the load on the soft wood if the effort applied is 30 N (assuming the wedge is 100% efficient).
6. Explain how screws could be considered to be similar to inclined planes.
7. Describe the three classes of lever and give a practical example of each.
8. Explain how a jackscrew is used and how to calculate its ideal mechanical advantage.



### Contents

Section	Learning competencies
6.1 Air pressure (page 141)	<ul style="list-style-type: none"> <li>• Define the term air pressure and use the definition to solve related problems.</li> <li>• Describe atmospheric pressure and explain its variation with altitude.</li> <li>• Explain how to measure atmospheric pressure and show that 760 mmHg is equal to one atmosphere.</li> </ul>
6.2 Fluid pressure (page 151)	<ul style="list-style-type: none"> <li>• Define the term fluid and state the similarities and differences between liquids and gases.</li> <li>• Define the term density and relative density and determine each for a given body.</li> <li>• Explain how the pressure in a liquid at rest varies.</li> <li>• Apply the formula <math>p = h\rho g</math> and use it to solve problems (including determining the pressure inside a fluid taking into account atmospheric pressure).</li> <li>• State Pascal's principle, and apply it to solve problems and explain applications (such as the hydraulic lift).</li> <li>• Explain the use of a manometer.</li> <li>• Demonstrate an understanding of, distinguish between and calculate atmospheric, gauge and absolute pressure.</li> <li>• State Archimedes's principle and the principle of flotation.</li> <li>• Distinguish between true weight and apparent weight of a body.</li> <li>• Calculate the buoyant force acting on the body in a fluid and explain why bodies float or sink.</li> <li>• Calculate the density of a floating body or density of a fluid using the flotation principle.</li> </ul>

How does a massive ocean liner, made of steel, float on the water, yet a tiny penny sinks? Why is it when you go swimming you can feel the water pushing up on you, yet you can't feel the massive weight of the column of air on top of your head? This is all down to fluid statics, the study of the density and pressure in stationary liquids and gases.

From simply breathing in and out, to the blood pumping through your veins, pressure in liquids and gases plays an important role in our lives. Without atmospheric pressure our blood would simply boil and life on Earth would not even be possible.

In this unit we will investigate atmospheric pressure, look into what causes pressure in liquids and gases, explore the factors that affect it and learn how to use a range of simple pieces of equipment to measure pressure.

## 6.1 Air pressure

By the end of this section you should be able to:

- Define the term air pressure and use the definition to solve related problems.
- Describe atmospheric pressure and explain its variation with altitude.
- Explain how to measure atmospheric pressure and show that 760 mmHg is equal to one atmosphere.



**Figure 6.1** Injections don't hurt much because the needle exerts a very high pressure on the skin.

### Under pressure

If you've ever had an injection you will have noticed how easy it is for the doctor to push the needle through your skin. This is because the needle has a very sharp point and so when the doctor exerts a relatively small force the needle creates a great deal of pressure on the skin.

Pressure is defined as the amount of *force acting per unit area*.

- **Pressure is equal to force per unit area.**

If a large force acts on a small area it creates a greater pressure. For example, most animal predators have pointed teeth. When a crocodile or shark bites into its prey, the pressure is very large and so the teeth sink in!

The reverse is also true. A large vehicle like a tractor or truck may have some very large tyres. These increase the area over which the force is acting and so reduce the pressure. This means it is less likely for the tractor to sink into the mud and get stuck.

The pressure exerted by a force may be calculated using the equation below:

- $\text{pressure} = \text{force} / \text{area}$
- $p = F / A$

$p$  = pressure in Pa.

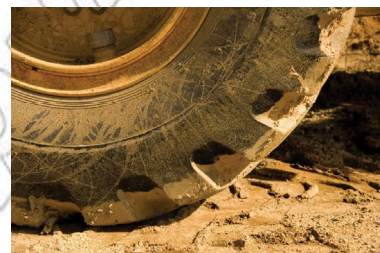
$F$  = force in N.

$A$  = area in  $\text{m}^2$ .

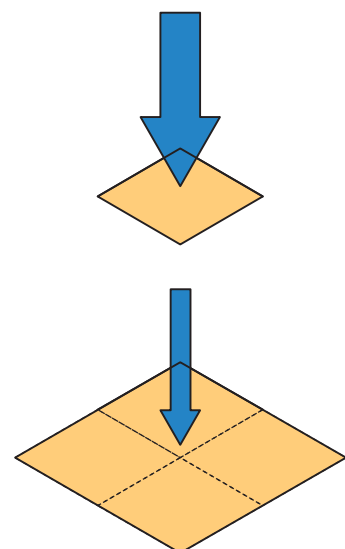
Pressure is measured in pascals. One pascal is equal to a pressure of 1 N per square metre ( $1 \text{ N/m}^2$ ). The pascal is the SI derived unit of pressure (this includes all forms of pressure).

### Worked example

A boy weighs 500 N and the soles of his feet have an area of  $0.05 \text{ m}^2$ . Determine the pressure he exerts when he stands  
a) on both feet and b) on one foot.



**Figure 6.2** The area over which the force is acting affects the pressure it exerts.



**Figure 6.3** A large force pressing on a small area creates greater pressure than a smaller force on a larger area.

**DID YOU KNOW?**

The pascal is named after Blaise Pascal. He was a French physicist most noted for his experiments with barometers in the mid-17th century (a barometer is an instrument to measure air pressure; more on this later).

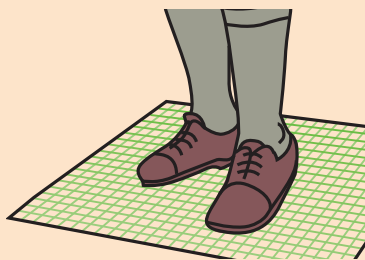
**Activity 6.1: Pressure**

Complete the table below:

Force	Area	Pressure
720 N	4.0 m <sup>2</sup>	
	0.02 m <sup>2</sup>	240 kPa
5.0 N		1.0 Pa

**Activity 6.2: Your own pressure**

Stand on a piece of squared paper. Carefully draw around your feet (or get a partner to do this for you).



**Figure 6.4** In order to determine the pressure you exert you need to measure the area of your feet!

Use this to work out the area of your feet (to do this count the number of squares and multiply by the area of each square).

Measure your weight in N (or your mass in kg and multiply by 10 N/kg), then use the equation  $p = F / A$  to determine your pressure.

On both feet:

$$p = F / A \text{ State principle or equation to be used (definition of pressure)}$$

$$p = 500 \text{ N} / 0.05 \text{ m}^2 \text{ Substitute in known values and complete calculation}$$

$$p = 10\,000 \text{ Pa or } 10 \text{ kPa Clearly state the answer with unit}$$

If he stands on one foot his weight will be the same but the area will be halved to 0.025 m<sup>2</sup>:

$$p = F / A \text{ State principle or equation to be used (definition of pressure)}$$

$$p = 500 \text{ N} / 0.025 \text{ m}^2 \text{ Substitute in known values and complete calculation}$$

$$p = 20\,000 \text{ Pa or } 20 \text{ kPa Clearly state the answer with unit}$$

We didn't really need to do that last calculation. We can see that if the area halves and the force stays the same then the pressure doubles (pressure is inversely proportional to area).

**Worked example**

A book rests on a desk. Its covers measures 20 cm by 25 cm. It exerts a pressure of 100 Pa. Determine the mass of the book.

$$p = F / A \text{ State principle or equation to be used (definition of pressure)}$$

$$F = p \times A \text{ Rearrange equation to make } F \text{ the subject}$$

In order to find the mass we first need to find the weight of the book. This is the force the book exerts on the desk. The area of the book is  $0.20 \text{ m} \times 0.25 \text{ m} = 0.05 \text{ m}^2$ .

$$F = 100 \text{ Pa} \times 0.05 \text{ m}^2 \text{ Substitute in known values and complete calculation}$$

$$F = 5 \text{ N Clearly state the answer with unit}$$

This is the weight of the book so to find its mass we use  $w = mg$ .

$$w = mg \text{ so } m = w / g \text{ State equation and rearrange equation to make } m \text{ the subject and solve}$$

$$m = 5 \text{ N} / 10 \text{ N/kg Substitute in known values and complete calculation}$$

$$m = 0.5 \text{ kg or } 500 \text{ g Clearly state the answer with unit (ideally kg)}$$

**What causes air pressure?**

Although we can't feel it in our day to day lives, air has mass. This means it also has a weight. One cubic metre of air has a mass of about 1 kg and so a weight of 10 N. The simplest way to think about air pressure is to treat it as the pressure due to the weight of the air above pushing down on a certain area. This may seem like a silly idea but actually it is pretty close to the truth.

A more complete picture involves thinking about the actual air particles. These are in constant motion, they are travelling in different directions and some travel faster than others. When the air particles are near a surface some will bounce into it and so exert a force on the surface. It is this force that gives rise to a pressure.

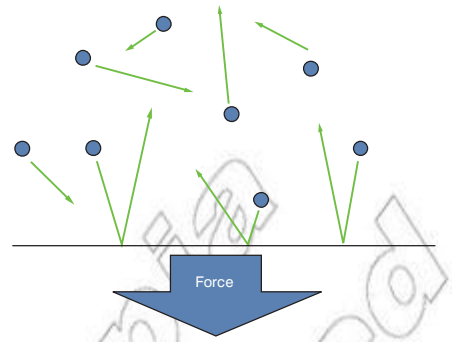
## Atmospheric pressure

The **atmosphere** is the layer of air that surrounds the Earth. Above your head right now there is a column of air about 40 km tall. The exact height is quite hard to determine due to the fact that as the height above the ground increases the air gets thinner and thinner until there is practically no air.

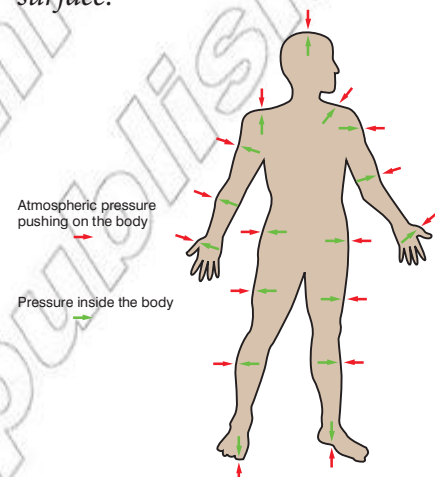
This column of air has a weight, which presses down on you and it is this that gives rise to atmospheric pressure.

We don't normally notice atmospheric pressure. If you move your hands up and down you can't really feel it, but it is definitely there! The reason we don't feel it is because not only does it push on you equally from all directions (left, right, front and back) but our bodies push back out.

There is a kind of **equilibrium** between the pressure in our bodies and the surrounding atmosphere. If you went somewhere where the pressure was much greater than atmospheric pressure our bodies would be crushed. For example, deep-sea submarines have to be very strong to withstand the crushing effect caused by the pressure of the water.



**Figure 6.5** Air particles crashing into a surface apply a force to that surface.



**Figure 6.6** The pressure in our bodies pushes back against atmospheric pressure.



**Figure 6.7** A deep-sea submarine has to withstand very high pressures.

The reverse is also true. If you went somewhere where the pressure was very low (e.g. into space without a pressurised space suit) the pressure inside our bodies would push outwards with some very nasty effects!

## How big is atmospheric pressure?

The weight of the column of air above  $1 \text{ m}^2$  at ground level is around  $101\,000 \text{ N}$ ! This means atmospheric pressure at ground level is around  $101 \text{ kPa}$ . This is often referred to as 1 atmosphere or 1 atm:

- $1 \text{ atm} = 101 \text{ kPa}$



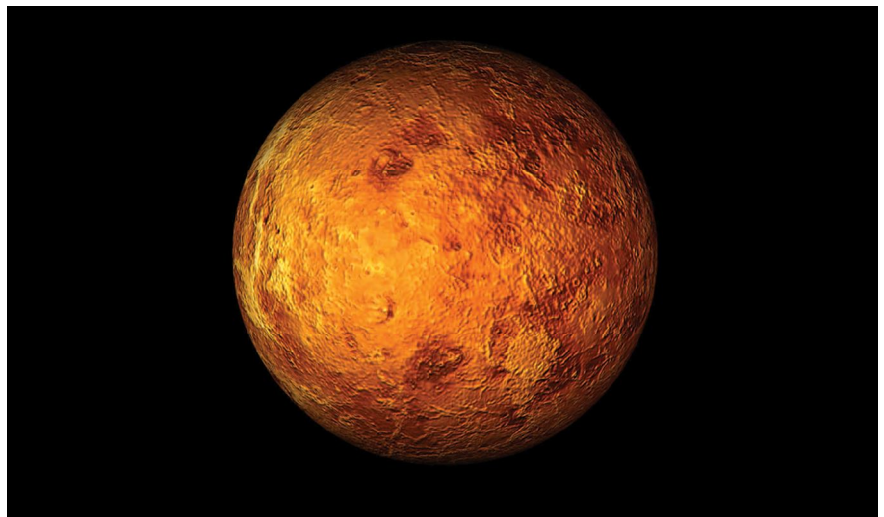
**Figure 6.8** Without a pressurised space suit this astronaut would experience severe difficulties.

**Think about this...**

In fact the pressure inside our bodies is generally a bit higher than atmospheric pressure. Think about how you already know this and why do you think this is important?

**DID YOU KNOW?**

The planet Venus has a much denser atmosphere that we do on Earth. The pressure on the surface is around 90 atm! That is 9 MPa or 9 million N per square metre. That is the same pressure you would experience if diving to a depth of nearly 1 km under water.

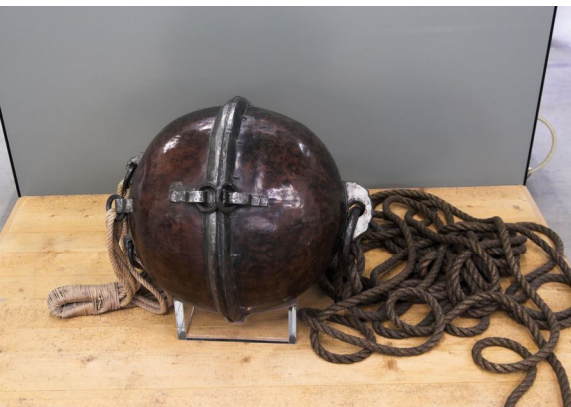


**Figure 6.9** Venus has a much greater atmospheric pressure than the Earth.

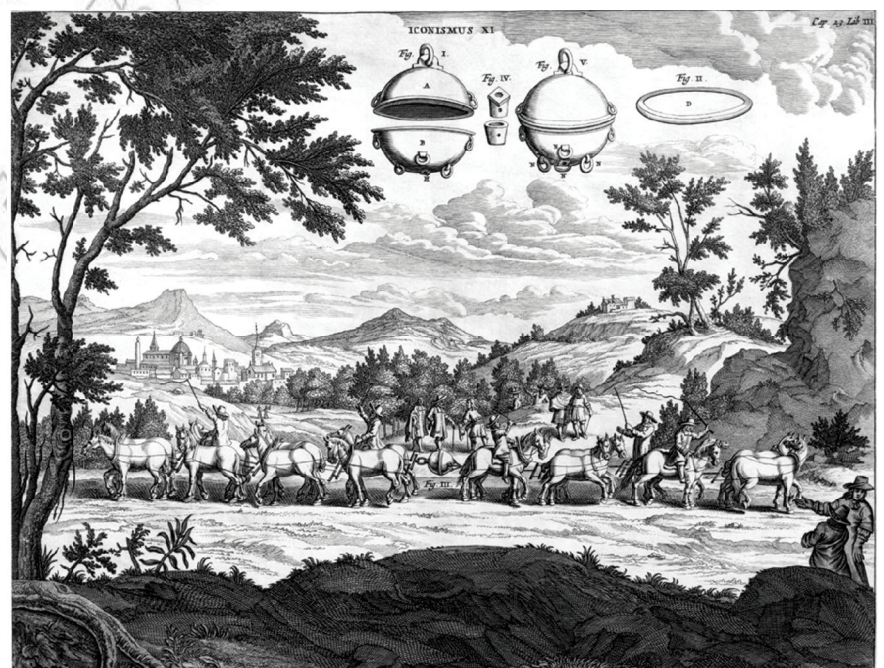
101 000 Pa is a very large pressure, but we rarely notice it in our day to day lives. It is about the same as having a medium-sized elephant balance on the top of your head!

In the mid-17th century a German named Otto Von Guericke (who was mayor of Magdeburg) invented a **vacuum pump**. This clever machine removed the air from inside a chamber and so the force due to atmospheric pressure could really be seen.

Von Guericke used his pump to removed air from inside two brass hemispheres touching each other. With the air removed the pressure from the atmosphere squeezed the two hemispheres together. With no counter pressure from the air inside, the hemispheres were locked tightly together. In 1654, in front of Emperor Ferdinand III, he demonstrated how tightly by using thirty horses in two teams of 15 to try to separate the hemispheres. They couldn't do it!



**Figure 6.10** Magdeburg hemispheres



**Figure 6.11** Teams of horses could not pull the hemispheres apart.

**KEY WORDS**

**atmosphere** the layer of air surrounding the Earth

**vacuum pump** a machine for removing the air from inside a chamber

The atmospheric pressure pushing the two hemispheres together was too strong. The hemispheres could not be separated. It was not until air was allowed back inside the hemispheres that the difference in pressure was small enough to allow them to be pulled apart.

### What effect does altitude have on atmospheric pressure?

The actual atmospheric pressure in the room today might be a bit higher or lower than 1 atm. The heating effect from the Sun causes small changes in pressure due to the uneven heating of the Earth's surface. This leads to high or low pressure weather systems. You can think of a high pressure system as meaning there is a slightly greater mass of air above your head than on an average day.



**Figure 6.12** Differences in atmospheric pressure can lead to powerful storms.

The height above sea level, or altitude, also has a significant effect on atmospheric pressure. Imagine climbing a tall mountain; the higher you get, the smaller the column of air above you. This means there is a smaller mass of air above you and so less weight pushing down.

As altitude increases the atmospheric pressure decreases.

Table 6.1 shows how the pressure varies with altitude. You can see that it is not a simple relationship and it depends on temperature changes and position on the Earth.

**Table 6.1** Pressure at different altitudes

Altitude (m)	Approx. pressure (Pa)
0	101 000
1000	90 000
2000	79 000
5000	54 000
10 000	26 000
15 000	12 000
20 000	6000
25 000	1300
30 000	270



**Figure 6.13** As you climb a mountain the surrounding atmospheric pressure drops.

### Activity 6.3: Atmospheric pressure

Fill a glass to the very top and then place a card on top of it. Make sure there is no air trapped between the glass and the card.

While holding the card carefully turn the glass over and then let go of the card.

It should stay in place! Atmospheric pressure is pushing the card up and preventing the water from rushing out.

### Activity 6.4: The effect of altitude

Plot a graph of altitude against atmospheric pressure using the information in Table 6.1.

### DID YOU KNOW?

At 1 atm, water boils at 100 °C. However, if the atmospheric pressure drops so does the boiling point. At the top of tall mountains the pressure is so low water will boil at 75 °C! In the mid-19th century explorers used this fact to determine their altitude.



Figure 6.14 A barometer

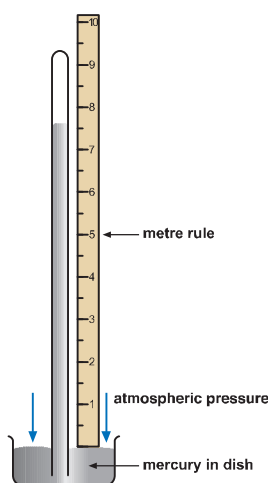


Figure 6.15 A diagram of a simple barometer

### DID YOU KNOW?

The volume of an object is affected by the temperature and the surrounding pressure. Chemical reactions also depend on pressure and temperature. In order to ensure experiments are conducted under the same conditions across the globe the International Union of Pure and Applied Chemistry (IUPAC) define standard temperature and pressure as a temperature of 0 °C and a pressure of 100 kPa. However, several different organisations use slightly different values!

## Measuring atmospheric pressure

There are several instruments used to measure atmospheric pressure. The most common is a **barometer**.

Think about the mercury in the dish. On the outside, air pressure is pressing down on the mercury. On the inside, the column of mercury in the tube is pressing down with an equal pressure. If these pressures were not equal, the level of mercury in the tube would alter until the pressures were balanced.

Until about 1650 the rise of liquid up a tube was explained by saying that the vacuum ‘sucks up’ the liquid. This is not so – a vacuum cannot suck, because there is nothing there to do the sucking! The rise is due to air pressure on the surface of the liquid outside.

A mercury barometer is long and inconvenient, heavy, and contains a liquid that is hazardous and easily spilt. Therefore, an **aneroid barometer** is commonly used. (*Aneroid* means *without liquid*.) It is compact and portable. A flat circular metal box, with only a little air inside, is the important part (Figure 6.16). A spring prevents its sides from being pushed in. The box is corrugated to make it strong, so that it does not collapse under air pressure. When the pressure changes, the upper face of the box moves. The movement is magnified several hundred times by a system of levers, which move a pointer over a circular scale, graduated in centimetres. It is graduated by comparing its readings with those of a mercury barometer.

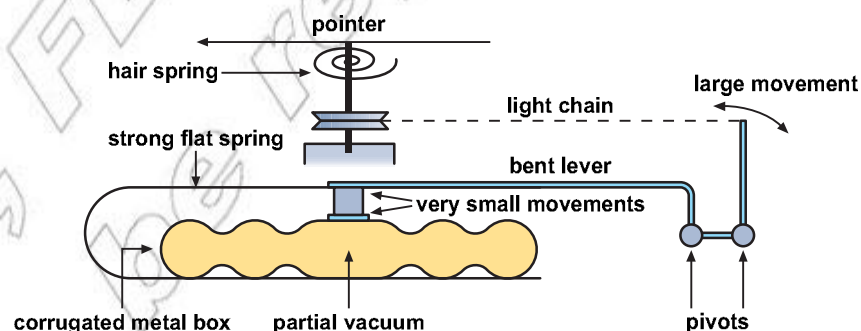


Figure 6.16 The construction of an aneroid barometer

### Why 760 mmHg?

Pressure is often expressed in the units of mmHg. If the atmospheric pressure is equal to 1 atm then the height of the column of mercury in a barometer is 760 mm. We can prove this mathematically.

The column of mercury will have a weight and the weight must equal the force due to the atmospheric pressure pushing up on the bottom of the column. Let's imagine a column of mercury 760 mm tall with a radius of 5 mm. This exerts a force equal to its weight. The weight is given by  $w = mg$  and we can determine the mass of the column from its density and volume ( $\rho = m / V$  and so  $m = \rho V$  and  $V = \pi r^2 h$  as this is the volume of a cylinder). So:

- $V = \pi r^2 h$

- $V = \pi(0.005 \text{ m})^2 \times (0.76) \text{ m}$
- $V = 5.97 \times 10^{-5} \text{ m}^3$

The density of mercury is  $13\,570 \text{ kg/m}^3$  so its mass is:

- $m = \rho V$
- $m = 13\,570 \text{ kg/m}^3 \times 5.97 \times 10^{-5} \text{ m}^3$
- $m = 0.81 \text{ kg}$

Therefore the weight of the column can be found:

- $w = mg$
- $w = 0.81 \text{ kg} \times 9.81 \text{ N/kg}$
- $w = 7.9 \text{ N}$

This weight must equal the force due to the pressure on the bottom of the column. So we can use the pressure equation to determine the pressure required to support of column of this height.

- $p = F/A$

As it is a cylinder the area of the base of the column is given by  $A = \pi r^2$  so:

- $p = F / \pi r^2$
- $p = 7.9 \text{ N} / \pi \times (0.005 \text{ m})^2$
- $p = 101\,000 \text{ Pa}$  or  $101 \text{ kPa}$

You can repeat the calculation above for columns with different radii; the answers are always the same! You can combine all the steps into one big equation:

- $p = \rho \pi r^2 h g / \pi r^2$

The areas cancel, which shows that the area of the column does not matter. Any column will reach the same height. This gives us:

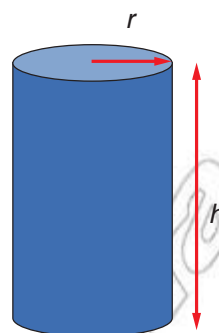
- $p = \rho h g$  (more on this equation later).

You might ask, why use mercury? Mercury is quite toxic and needs to be handled very carefully; why not use water instead? This is because water has a much lower density than mercury (around  $1000 \text{ kg/m}^3$  vs.  $13\,600 \text{ kg/m}^3$ ). This means for that atmospheric pressure can support a column of water around 10 m tall! This would make our barometer far too large to be practical.

### Some uses of air pressure

There are several uses for air pressure. Most rely on creating a **pressure difference** by pumping air into or out of a chamber. Pumping air into a chamber creates a greater pressure and pumping air out of a chamber creates a lower pressure.

If you create an area of lower pressure then the atmospheric pressure is larger in relative terms. As a result air is *pushed* in due to the greater force from the atmospheric pressure. Notice that there is no such thing as sucking to pull air into a machine.



**Figure 6.17** The volume of a cylinder

### Think about this...

As atmospheric pressure can support a column of water 10 m high this is also the maximum height to which a column of water can be drawn up by a vacuum pump (i.e. by creating a pressure difference). For any higher, water pumps must be used.

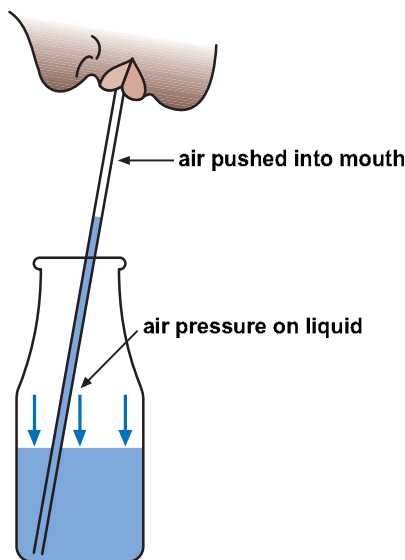
### KEY WORDS

**aneroid barometer** a device for measuring atmospheric pressure that uses a corrugated metal box rather than liquid

**barometer** a device for measuring atmospheric pressure

**pressure difference** the relative value of the pressure of gas in different chambers





**Figure 6.18** Atmospheric pressure pushes the drink up the straw

### KEY WORDS

**common pump** a pump that relies on atmospheric pressure to move water

**drinking straw** a thin tube used to suck liquids into the mouth

**force pump** a pump that relies on atmospheric pressure and compressed air to move water, often to a great height

**lift pump** a pump that relies on atmospheric pressure to move water

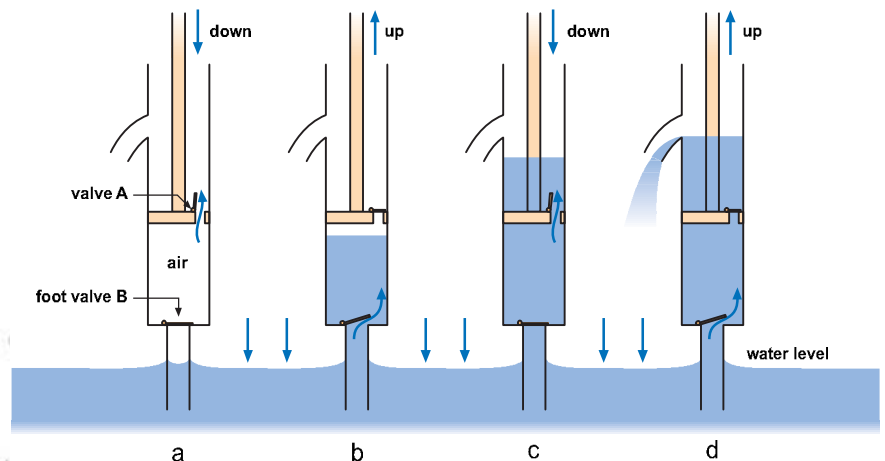
**suction pad** a round rubber pad that relies on atmospheric pressure to stick to smooth surfaces

## Uses of air pressure

A **suction pad** is a round rubber pad, perfectly flat on one side. Wet this side and press the pad against a window or smooth wall, pushing out all the air from under it. The pad sticks firmly. Atmospheric pressure holds it in place. The pads are used to lift and move large sheets of plate glass, metal and plastics, to put notices on windows, and on many toys, e.g. arrows, that stick to walls.

If you drink through a **drinking straw**, you are making use of atmospheric pressure. You suck on the air inside the straw. Therefore the atmospheric pressure outside is greater than the pressure inside, and liquid is pushed up (Figure 6.18).

A **lift pump (common pump)** is often used to raise water from wells. A piston moves up and down a tube (Figure 6.19). There is a valve in the piston and also one at the end of the tube. A valve is usually made of leather, and has brass on it to make it heavy. The valves are normally shut. They let water pass upwards but not downwards.



**Figure 6.19** The four stages in the operation of a lift pump

- **Downstroke:** Foot valve B closes under its own weight. Valve A opens and lets air pass through it into the space above the piston.
- **Upstroke:** Valve A closes under its own weight. The pressure under the piston is less than atmospheric. Atmospheric pressure forces water into the tube through B.
- **Downstroke:** Valve B closes and A opens. Water passes through A into the space above the piston.
- **Upstroke:** Valve A closes and water is lifted up the tube and out of the spout. More water passes through B to keep the pump filled.

Atmospheric pressure determines the height to which water can be pumped. Even a perfect pump can raise water only 10.4 m. In practice, because of leaks at the valves and piston and of dissolved gases from the water, most pumps raise water about 7 m only. Delivery of water is not continuous.

A **force pump** can pump water to a great height. Some, used by firemen, can force water hundreds of metres high.

There is a foot valve B (see Figure 6.20), as in the lift pump, but it has a solid piston and a delivery tube at the bottom of the pump. There is a valve A in the delivery tube where it joins a chamber.

- *Upstroke:* The pressure in the tube under the piston becomes less. Valve A closes and foot valve B opens. Water is forced through B into the tube by atmospheric pressure.
- *Downstroke:* B closes. Valve A opens; water is forced through it and the delivery pipe into chamber C. The pressure on the piston (and not atmospheric pressure) determines the height to which the water is pumped.

The force pump itself delivers water only on the downstroke; the flow of water stops on the upstroke. However, the air trapped in chamber C is compressed during every downstroke. The pressure of this air continues to force out water during the upstroke, and therefore the pump delivers a steady stream of water.

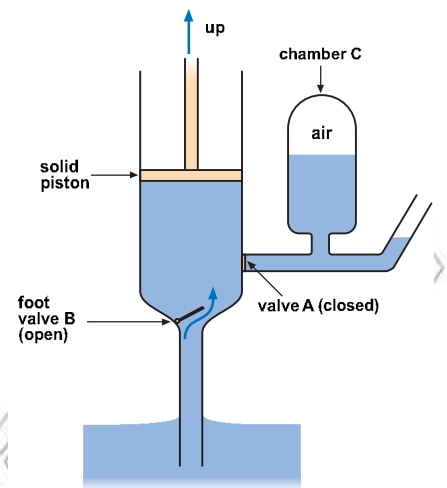


Figure 6.20 A force pump

### Bicycle pump

The handle moves a piston in a metal cylinder (Figure 6.21). There is a cup-shaped leather or rubber washer on the end of the piston. This acts as a valve and lets air move in one direction only. The soft edge of the washer fits closely to the sides of the cylinder.

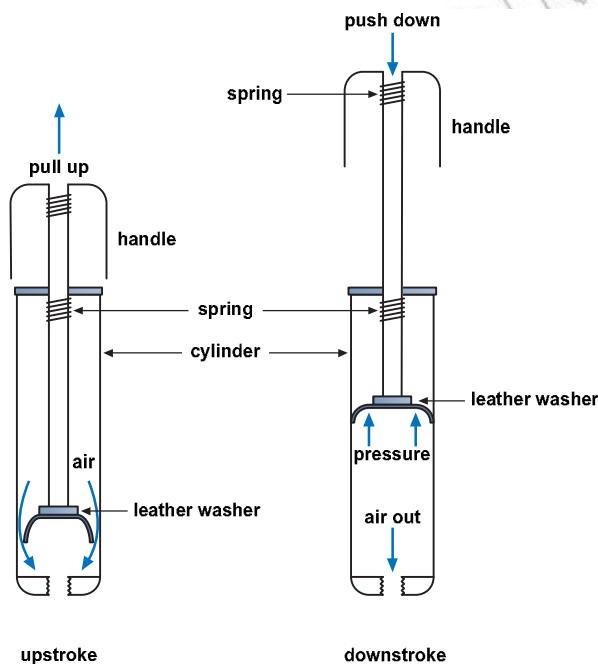


Figure 6.21 How a bicycle pump works

- *Upstroke:* The pressure below the piston is reduced. Atmospheric pressure forces air between the washer and the wall of the cylinder.
- *Downstroke:* The pressure below the piston is increased. The washer is pressed tightly against the walls of the cylinder, making it airtight. When the pressure rises above the pressure inside the tyre, the tyre valve opens and air is forced into the tyre.

**KEY WORDS**

**siphon** a tube which can move liquid using the difference between the pressure of the liquid and atmospheric pressure

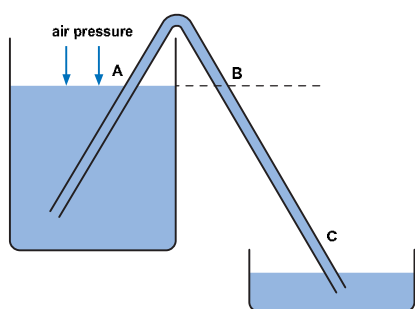


Figure 6.22 A siphon

**Activity 6.6: Vacuum cleaner**

Can you explain how a simple vacuum cleaner works? Remember that it does not suck up the dust.

A bicycle pump with the washer reversed acts as a vacuum pump or suction pump.

**Siphon**

A **siphon** is a convenient way of removing liquid from a container such as an aquarium or petrol tank.

**Activity 6.5: To show the action of a siphon**

- Fill a tall jar with water. Submerge a long rubber tube so that it fills with water.
- Leave one end in the water, close the other end with the fingers (to prevent the water running back), and lift it out of the jar. Lower this end until it is below the water level in the jar. Open it and let water flow out into a second jar (Figure 6.22).

The water flows so long as the end C is below water level A. The further C is below A, the faster is the flow of water.

- Now raise the second jar until it is higher than the first. Water flows in the other direction. (The tubing must always be full of water and its ends must be under the water.)

**How a siphon works**

The pressure at A and B is atmospheric. Therefore the pressure at C is atmospheric pressure plus the pressure due to the column of water BC. Hence, the pressure at C is greater than atmospheric and the water can push its way out against the atmosphere.

**Summary**

In this section you have learnt that:

- Pressure is defined as the force acting per unit area. It can be calculated using the equation  $p = F/A$ .
- Pressure is measured in pascals (Pa), where 1 Pa equals a pressure of 1 newton per square metre.
- Atmospheric pressure is caused by the weight of the column of air above you pushing down on you. On a typical day this is equal to 101 kPa.
- As your altitude increases the atmospheric pressure decreases.
- A barometer is a simple instrument used to measure atmospheric pressure. The pressure from the atmosphere pushes the fluid up the tube.
- 1 atm is equal to 760 mmHg.

## Review questions

1. Define pressure and states its units.
2. A wooden block of mass 2.0 kg is 20 cm thick, by 10 cm wide by 30 cm tall. Calculate the minimum and maximum pressure this block could exert on a surface.
3. Explain the causes of atmospheric pressure and why it changes with altitude.
4. Describe how a barometer works and show that at 1 atm the height of a column of mercury would equal 760 mm.
5. Calculate the pressure in Pa if the reading from a barometer is 820 mmHg.

## 6.2 Fluid pressure

By the end of this section you should be able to:

- Define the term fluid and state the similarities and differences between liquids and gases.
- Define the term density and relative density and determine each for a given body.
- Explain how the pressure in a liquid at rest varies.
- Apply the formula  $P = h\rho g$  and use it to solve problems (including determining the pressure inside a fluid taking into account atmospheric pressure).
- State Pascal's principle, and apply it to solve problems and explain applications (such as the hydraulic lift).
- Explain the use of a manometer.
- Demonstrate an understanding of, distinguish between and calculate atmospheric, gauge and absolute pressure.
- State Archimedes's principle and the principle of flotation.
- Distinguish between true weight and apparent weight of a body.
- Calculate the buoyant force acting on the body in a fluid and explain why bodies float or sink.
- Calculate the density of a floating body or density of a fluid using the flotation principle.

### What are fluids?

Can you name a **fluid**? I suspect you came up with either water, an oil of some sort, petrol or maybe something like milk. However, I doubt many, if any, of you came up with air. In physics a fluid refers to a substance that will **flow** along a pipe. In common use fluids tend to mean just liquids. However, in science fluids include all **gases** as well as **liquids**

### KEY WORDS

**flow** *smooth unbroken movement of a substance*

**fluid** *a substance that will flow e.g. gases, liquids*

**gases** *substances in a state of matter where particles can move about randomly and are widely spaced, with no bonds between them*

**liquids** *substances in a state of matter where there are weak bonds between the particles which are close together but can still move*



Figure 6.23 Natural gas is a fluid.

Another characteristic of fluids is that they can change their shape. This means they always take the shape of the container they are put in. For example, consider a rectangular glass box. A liquid and gas will both fill the bottom of the container; however, a solid will not.

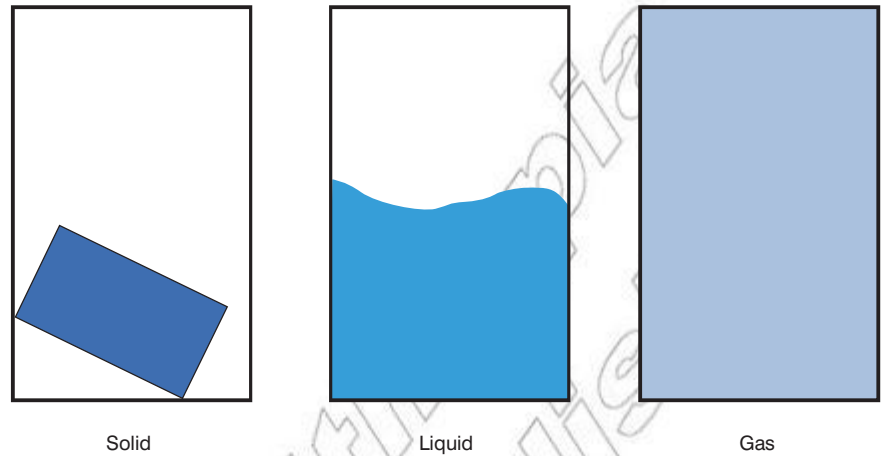


Figure 6.24 Fluids take the shape of their container.

**KEY WORDS**

**incompressible** where the volume of a substance stays the same when force is applied

**density** the mass per unit volume of a substance

There are still some very important differences between liquids and gases. Perhaps the most important is the fact that gases can be compressed by forces. You can squeeze a balloon filled with air and its volume will go down. However, liquids are **incompressible**; effectively this means the volume of a liquid stays the same when force is applied.

Table 6.2 summarises the key properties of liquids and gases.

Table 6.2 Liquids and gases

	Liquid	Gas
Particles	Quite close together, with no set pattern; particles can move past each other.	Far apart with no set pattern; particles can move past each other.
Bonding	Weak bonds between the particles	No bonding between the particles
Can flow / change their shape to match a container	Yes	Yes
Compressible	No; the particles are already close together.	Yes; there is lots of space between the particles.

**Fluid density**

The **density** of any fluid may be calculated using the standard equation for density:

- density = mass / volume
- $\rho = m / V$
- **Density is defined as mass per unit volume.**

As the particles are closer together in a liquid, liquids have higher densities than gases. Table 6.3 includes some typical densities of fluids.

Table 6.3 Densities of fluids

Fluid	Density (kg/m <sup>3</sup> )
Mercury	13 600
Honey	1400
Water	1000
Sea water	1020
Diesel	950
Alcohol	800
Petrol	740
Air	1.20
Carbon dioxide	1.98
Nitrogen gas	1.25

Both temperature and pressure have an effect on the volume of a fluid. Therefore the densities in Table 6.3 are at standard atmospheric pressure (101 kPa) and a temperature of 20 °C.

For liquids it is fair to assume that the density is uniform throughout the liquid (as they are incompressible). However, for large volumes of gas the density increases as the gas gets closer to the surface of the Earth (due to gravity). This is most noticeable in the Earth's atmosphere. As the altitude increases the air gets less dense; the air is described as getting thinner.

### What's relative density?

The term **relative density** is often used to compare the density between two fluids. In most cases this involves comparing the density of a fluid to that of water; however, it could be any other substance.

The relative density of a substance is the ratio between its density and the density of water. For example, if something has a relative density of two it means it is twice as dense as water. A relative density of 0.25 means it has  $\frac{1}{4}$  of the density of water. You can calculate relative density using:

- relative density = density of substance / density of water.

The relative density of alcohol would be:

- relative density = density of substance / density of water
- relative density =  $800 \text{ kg/m}^3 / 1000 \text{ kg/m}^3$
- relative density = 0.8.

Notice relative density has no units since it is a ratio.

If we are comparing two identical volumes of fluids then the relative density can be calculated as the ratio of the masses of the same volume of fluid:

- relative density = mass of substance / mass of equal volume of water

### Think about this...

Density is also often measured in g/cm<sup>3</sup>. 1 g/cm<sup>3</sup> is equal to 1000 kg/m<sup>3</sup>. How would convert from g/cm<sup>3</sup> to kg/m<sup>3</sup> and vice versa?

### KEY WORDS

**relative density** *the ratio between the density of two substances*

### Activity 6.7: Relative density

Determine the relative density of:

1. mercury
2. carbon dioxide
3. petrol
4. honey.

**Activity 6.8: Measuring relative density**

This method uses a density bottle (Figure 6.25) to find the relative density of a liquid. A density bottle has a ground-glass stopper, which fits exactly. There is a small hole in the stopper through which liquid and air can flow out when the stopper is put in the neck of the bottle. (This means that no air bubbles can be trapped under the stopper, which would give a false result.)

- Weigh a clean, dry density bottle with its stopper (mass = A).
- Fill with water and put in the stopper. Water should come out of the hole in the stopper. Dry the outside of the bottle and weigh it again (mass = B).
- Pour out the water, rinse with some of the liquid whose relative density is to be found. Fill with the liquid, put in the stopper, dry carefully and weigh (mass = C).

$$\text{Relative density} = \frac{\text{mass of liquid}}{\text{mass of water}} = \frac{(C - A)}{(B - A)}$$

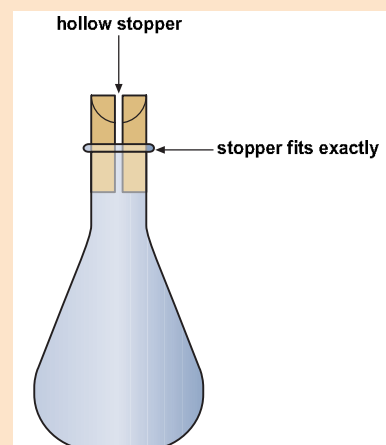


Figure 6.25 A density bottle

**DID YOU KNOW?**

If the relative density of a substance is relative to the density of water it is often called specific gravity. If the object has a specific gravity greater than 1, it will sink in water (more on this later).

**Pressure in fluids**

We've already discussed atmospheric pressure but if we investigate pressure in fluids in general we find there are two key points to consider:

- **Pressure increases with depth.**
- **At any given depth the pressure is equal in all directions.**

**Pressure and depth**

In any fluid the pressure increases with depth. The taller the column of the fluid above you, the greater the pressure it exerts. You can see this by conducting a very simple experiment.

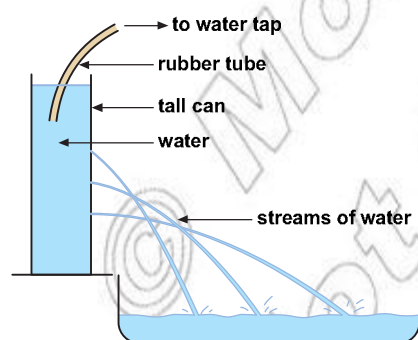


Figure 6.26 The effect of depth on pressure

**Activity 6.9: Pressure and depth**

Take a tall tin can and carefully make several holes going up one side (three or four should do it).

Quickly fill the tin with water and observe how the water squirts out of the holes.

You will notice that the stream from the bottom hole travels further. This is because the water is under more pressure at the bottom of the can.

We have already derived an equation for pressure in fluids in Section 6.1:

- $p = h\rho g$
- $p$  = pressure in Pa
- $h$  = depth of fluid in m
- $\rho$  = density of fluid in  $\text{kg/m}^3$
- $g$  = gravitational field strength (9.81 N/kg)

Be careful not to mix up  $p$  and  $\rho$  (the Greek letter rho); make sure you look carefully before completing any calculations.

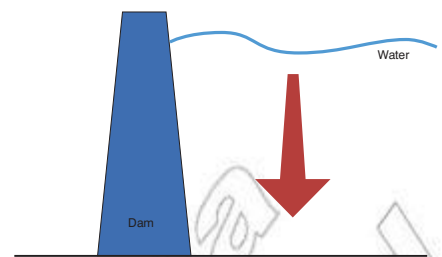
To recap:

Figure 6.28 shows a tank, filled with water of density  $\rho$  to a depth  $h$ . The base of the tank has area  $A$ . What is the pressure on the bottom of the tank?

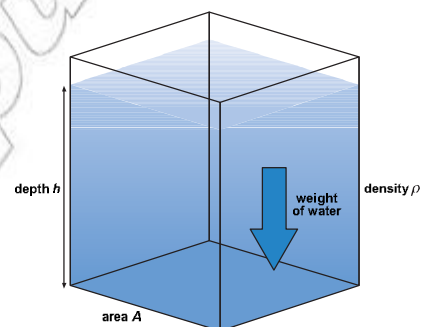
The pressure is caused by the weight of the water in the tank, pressing down on the bottom.

- Volume of water =  $h \times A$
- Mass of water = volume  $\times$  density =  $\rho \times h \times A$
- Weight of water = mass  $\times g = \rho \times h \times A \times g$
- Pressure = weight / area =  $\rho \times h \times A \times g / A = \rho \times h \times g$ .

This equation shows that the pressure increases with depth ( $h$ ); in fact the pressure exerted by the fluid is directly proportional to the depth of fluid. Dive twice as deep and the pressure exerted by the water above you is doubled.



**Figure 6.27** Dams have to be thicker at the bottom in order to withstand the greater pressure.



**Figure 6.28** The pressure on the bottom of the tank is caused by the weight of the water above it.

### Worked example

Calculate the pressure exerted by the water at the bottom of a swimming pool 6 m deep.

$p = h\rho g$  State principle or equation to be used (pressure in fluids)

$p = 6 \text{ m} \times 1000 \text{ kg/m}^3 \times 10 \text{ N/kg}$  Substitute in known values and complete calculation

$p = 60\,000 \text{ Pa}$  Clearly state the answer with unit

Calculate the force this pressure would exert on a concrete block with an area of  $3 \text{ m}^2$

$p = F / A$  State principle or equation to be used (definition of pressure)

$F = p \times A$  Rearrange equation to make  $F$  the subject

$F = 60\,000 \text{ Pa} \times 3 \text{ m}^2$  Substitute in known values and complete calculation

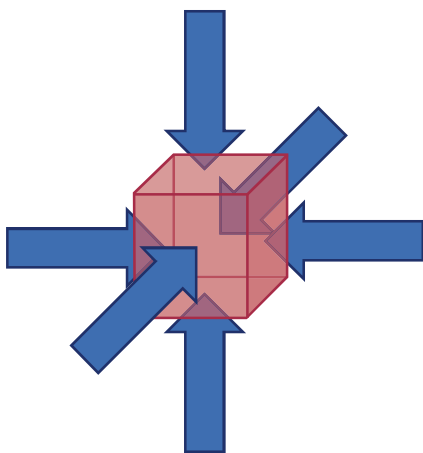
$F = 180 \text{ kN}$  Clearly state the answer with unit

### Activity 6.10: Pressure calculations

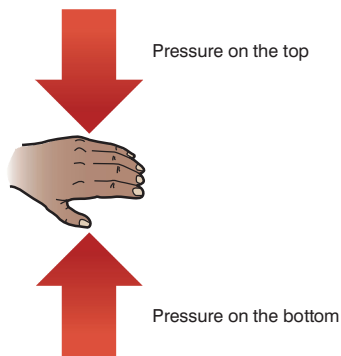
Using information in the density table (Table 6.3) calculate the pressure exerted by the fluid in the following situations:

1. Diving in sea water to a depth of 15 m.
2. The base of a column of mercury 760 mm tall.





**Figure 6.29** Pressure is the same in all directions on a small cube.



**Figure 6.30** The pressure on the top and on the bottom of your hand is essentially the same.

**DID YOU KNOW?**

This topic is called fluid statics (or hydrostatics), meaning we are dealing with stationary fluids. A moving fluid exerts less pressure on its surroundings. This is studied in hydrodynamics and is very important when it comes to keeping aircraft in the air.

**Pressure acts equally in all directions**

In fluids, despite the pressure being caused by the column of fluid above you, the pressure acts equally in *all directions*. If you imagine a very small cube placed under water, the pressure on each cube face would be the same.

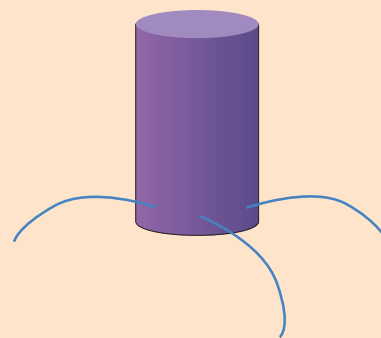
If you hold your hand up horizontally in front of you the pressure on the top is the same as the pressure on the bottom.

Technically there is a very small difference in the height of the column of air on the top compared to the bottom (the thickness of your hand) but essentially the pressure is the same.

**Activity 6.11: Pressure in a can**

You can show this using another tin can. This time make four or five holes at the same depth around the bottom of the can.

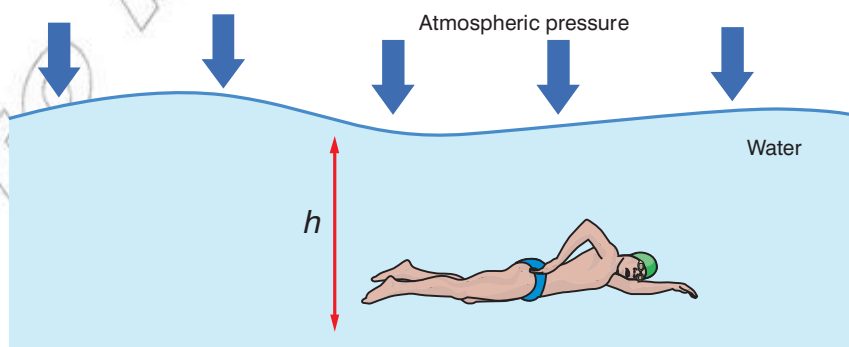
Again quickly fill it with water and you can see all the streams of water are the same. In other words the pressure is the same in all directions inside the can.



**Figure 6.31** Pressure is the same in all directions.

**What about the effect of atmospheric pressure?**

If you go swimming the pressure acting on you is not just due to the water above you. You must not forget to include atmospheric pressure.



$$p = p_{atm} + p_{fluid}$$

**Figure 6.32** The total pressure on a swimmer

The pressure on the swimmer would be the sum of the pressure due to the fluid and the atmospheric pressure. In terms of an equation this could be written as:

- $p = p_{atm} + h\rho_{fluid}g$

## Pascal's principle

### Activity 6.12: Water transmits pressure

- Take two syringes of different sizes. Connect them with plastic or rubber tubing. Fill the syringes and the tube with water (Figure 6.33).
- Press one syringe with one hand, and the other with the other hand. Feel how their forces differ.

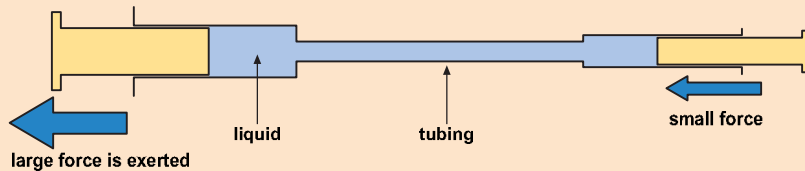


Figure 6.33 Using water pressure to magnify a force.

If you conduct the experiment above the difference in the forces is clear.

This difference comes down to the fact that liquids are incompressible; this means they can transfer pressure from one place to another. The force applied to the smaller syringe creates a pressure inside the liquid. This pressure is transferred throughout the liquid and is the same value everywhere. This pressure acts on the larger syringe and because the area of the syringe is larger the force exerted is also greater. Remember, from Unit 4, energy cannot be created or destroyed. Just like the simple machines studied in unit 5, if the output force gets bigger it must move through a smaller distance.

This phenomenon is referred to as **Pascal's principle** and it states:

- **The pressure applied to an enclosed fluid is transmitted to every part of the fluid, as well as to the walls of the container without reducing in value.**

Pascal's principle is used in the design and construction of simple **hydraulic machines**. Figure 6.34 shows two different sized pistons, which form part of a hydraulic system.

If a force is applied to the left hand piston it will create a pressure inside the fluid.

$$\bullet \quad p = F_1 / A_1$$

This pressure is transferred throughout the liquid. It is the same everywhere.

- $p$  on the left =  $p$  on the right.

The piston on the right has a much larger area. The force from this piston is equal to:

$$\bullet \quad F_2 = p \times A_2$$

### Worked example

Determine the pressure acting on a diver 20 m below the surface. •

$p = p_{atm} + h\rho_{fluid}g$  *Express total pressure in terms of atmospheric pressure and pressure from fluid*

- In this case,  $h = 20$  m and  $\rho_{fluid} = 1000$  kg/m<sup>3</sup>

$$p = 101\,000 \text{ Pa} + (20 \text{ m} \times 1000 \text{ kg/m}^3 \times 10 \text{ N/kg})$$

*Substitute in known values and complete calculation*

$$p = 301\,000 \text{ Pa or } 301 \text{ kPa}$$

*Clearly state the answer with unit*

### Think about this...

Discuss with a partner why this effect does not happen in gases.

### KEY WORDS

#### hydraulic machines

*machines that rely on the incompressibility of liquids to do work*

**Pascal's principle** *principle stating that the pressure applied to an enclosed fluid is transmitted to every part of the fluid without reducing in value*

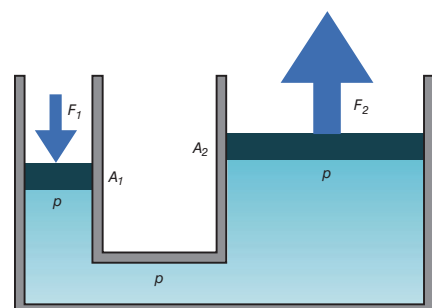


Figure 6.34 Pascal's principle

## KEY WORDS

**hydraulic lift** a hydraulic machine used to raise heavy objects

**hydraulic presses** a hydraulic machine used to shape metal or compress materials into smaller volumes

**hydraulic brakes** a mechanism which uses fluid to transfer pressure from a foot pedal to push brake pads onto brake discs

As  $A_2$  is much bigger than  $A_1$ ,  $F_2$  will also be bigger than  $F_1$ . In fact if the piston has double the area the force will be doubled. If the piston has ten times the area the force will be 10 times greater!

For example, let's imagine the areas are:

$$A_1 = 2 \text{ m}^2 \quad A_2 = 6 \text{ m}^2$$

If a force of 100 N is applied on  $A_1$  then the force at  $A_2$  will be 300 N (three times bigger). Let's prove it though calculation:

$$p = F / A \text{ State principle or equation to be used (definition of pressure)}$$

$$p = F_1 / A_1 \text{ Relate to this context}$$

$$p = 100 \text{ N} / 2 \text{ m}^2 \text{ Substitute in known values and complete calculation}$$

$$p = 50 \text{ N/m}^2 \text{ Clearly state the answer with unit}$$

From Pascal's principle the pressure is the same throughout the liquid so:

$$p = F_2 / A_2 \text{ State principle or equation to be used (definition of pressure expressed in this context)}$$

$$F_2 = p \times A_2 \text{ Rearrange equation to make } F_2 \text{ the subject}$$

$$F_2 = 50 \text{ N/m}^2 \times 6 \text{ m}^2 \text{ Substitute in known values and complete calculation}$$

$$F_2 = 300 \text{ N} \text{ Clearly state the answer with unit}$$

As the pressure is same throughout the fluid we can summarise the relationship between the forces and areas in the following equation:

- $F_1 / A_1 = F_2 / A_2$

### Hydraulic machines

Pascal's principle has many applications; one of the simplest is the **hydraulic lift**. This is used to lift a heavy object (such as a car) off the ground. Just like our example, a small force is applied to a smaller area piston. This creates a pressure inside a hydraulic fluid, which is transferred to a larger area piston. This piston creates a much larger force and, if the object to be lifted sits on top of the large piston, it can be easily lifted by the smaller force at the smaller area piston.

Other examples include hydraulic presses and hydraulic brakes (in cars).

**Hydraulic presses** are used to shape metal (e.g. make motor-car bodies), to press waste paper or cotton wool into bales of small size, to press oil from oil seeds, and to lift cars so that work can be done easily underneath.

**Activity 6.13: A hydraulic lift**

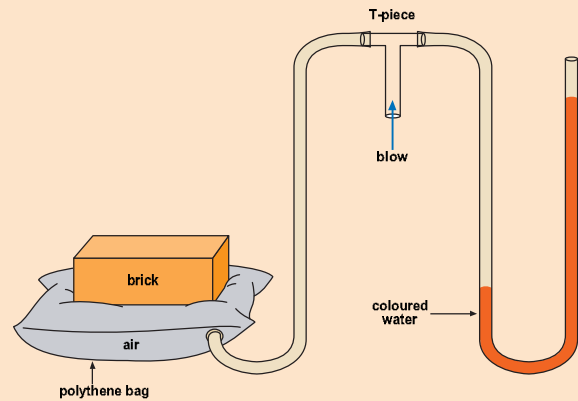
- **Inner tube method:**

Use the inner tube of a bus or lorry tyre. Take out the valve, and fit about 1.5 metres of rubber tubing to the tube over the metal valve. Put a funnel into the other end of the rubber tubing. Place a large wooden board on the flat inner tube, and stand on the board. Pour water into the funnel. The inner tube fills with water and lifts you.

- **Polythene bag method:**

Connect some rubber tubing to a closed polythene bag. Place a brick with its largest surface on the bag. Blow into the tubing. The brick is lifted.

Turn the brick so that a smaller surface is on the bag. A larger pressure is needed to lift the brick as much as before.

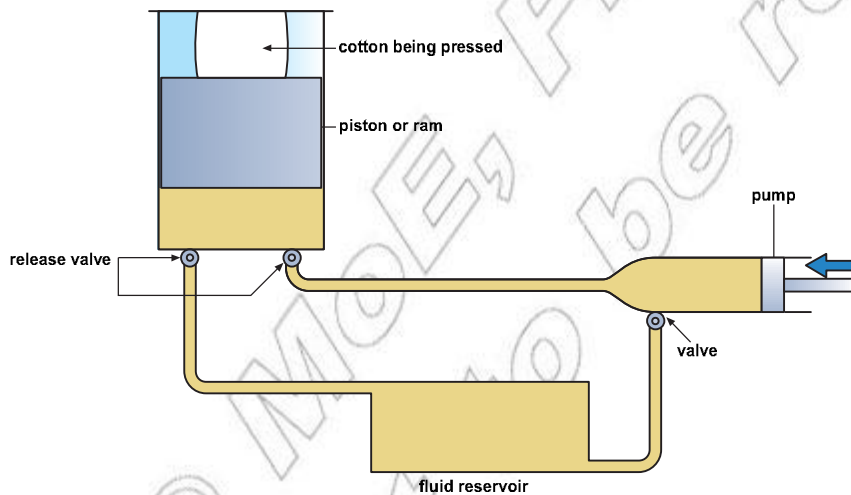


**Figure 6.35** A hydraulic lift operated by air pressure

The hydraulic press (Figure 6.36) changes a small force into a large one. It consists of a cylinder and a piston, of large diameter, joined by a pipe to a second cylinder and a piston of small diameter. Water or oil is pumped into the small cylinder, and it lifts the large piston with an enormous force. A release valve lets the liquid run away after the piston has done its work.

**Think about this...**

Why is it a serious problem if air bubbles get into the hydraulic brake lines of a car?



**Figure 6.36** A hydraulic press, used to compress a bale of cotton

A car's **hydraulic brakes** work in a similar way. By pressing the foot on the brake pedal, a small force is applied to a piston with a small diameter. The pressure is transmitted through oil pipes to pistons of large diameter on the car wheels. These push the brake pads against the brake discs to stop the wheels.



Figure 6.37 Pressure gauges may read absolute pressure or gauge pressure.

### KEY WORDS

**absolute pressure** *the actual pressure at a given point*

**gauge pressure** *the difference between absolute pressure and atmospheric pressure*

## What is the difference between atmospheric, gauge and absolute pressure?

When it comes to measuring the pressure of a fluid there are several different terms you may come across. These include atmospheric pressure, gauge pressure and absolute pressure.

### Absolute pressure

The **absolute pressure** is the actual pressure at a given point. It is the true pressure of a system if all of the factors are taken into account (including atmospheric pressure).

### Atmospheric pressure

Atmospheric pressure has already been discussed. It is the pressure of the surrounding air when measured at the surface of the Earth. It has a value of 101 kPa. Atmospheric pressure varies depending on the temperature, the altitude above sea level and the impact of weather systems.

### Gauge pressure

Pressure gauges often give readings of **gauge pressure** rather than absolute pressure. Gauge pressure is the pressure difference between a system and atmospheric pressure.

If the pressure gauge reads 25 kPa it would mean 25 kPa *above* atmospheric pressure (giving 126 kPa in total). If the gauge was disconnected it would read 0 Pa even though the absolute pressure is still 101 kPa.

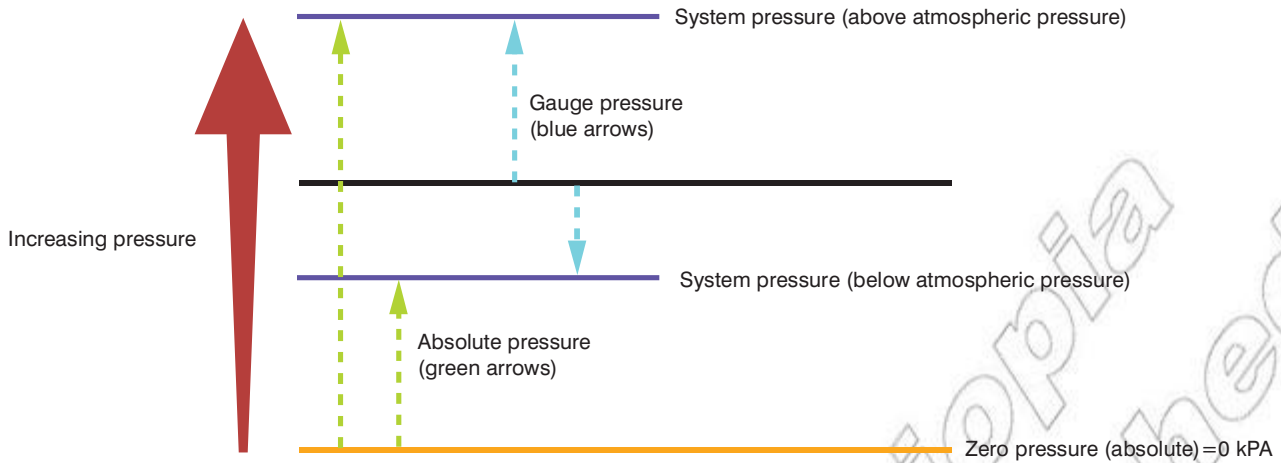
Gauge pressure can be calculated using the equation below:

- $p_g = p_s - p_{atm}$
- $p_g$  = gauge pressure
- $p_s$  = system pressure (the absolute pressure of the system being measured)
- $p_{atm}$  = atmospheric pressure

This is often used to determine the absolute pressure of the system. For example, if a compressed gas was measured and the gauge pressure of the system was 49 kPa then the absolute pressure would be:

- $p_g = p_s - p_{atm}$  so  $p_s = p_g + p_{atm}$
- $p_s = 49\,000\text{ Pa} + 101\,000\text{ Pa}$
- $p_s = 150\,000\text{ Pa}$

As gauge pressure is relative to atmospheric pressure it is possible to obtain negative readings. A reading of  $-10\text{ kPa}$  would mean 10 kPa *below* atmospheric pressure.



**Figure 6.38** The relationship between gauge pressure, absolute pressure and atmospheric pressure

## Measuring pressure

We have already looked at simple and aneroid barometers. However, there are a number of other ways to measure the pressure of a fluid. Most modern techniques use electronic pressure sensors. However, there are two other common mechanical techniques.

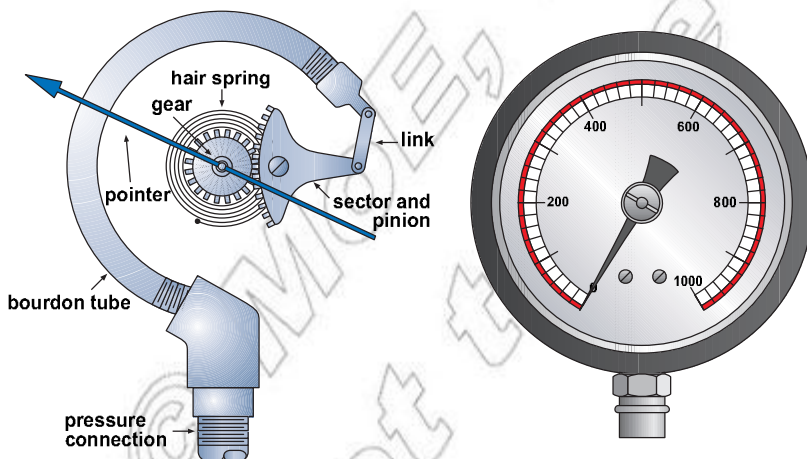
### Bourdon gauge

A **Bourdon gauge** is a more practical instrument for measuring the pressure of a gas (Figure 6.39). Inside the gauge is a flattened tube with one end sealed. The tube is coiled round in a spiral. The open end is connected to, say, the gas supply. As the gas presses in, it causes the spiral tube to uncurl slightly. This makes the needle move round the dial, indicating the pressure.

### KEY WORDS

**Bourdon gauge** an instrument for measuring the pressure of a gas

**manometer** a U-shaped tube filled with liquid which is used to measure pressure



**Figure 6.39** A Bourdon gauge

### Manometer

A **manometer** is a simple instrument often used to measure the pressure of a gas supply. It comprises a U-shaped tube open at both ends. The tube is filled with a liquid (this is often coloured to make it easier to see).

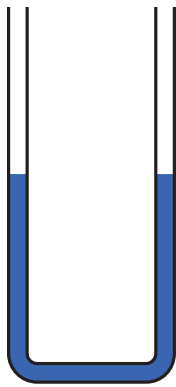


Figure 6.40 A simple manometer

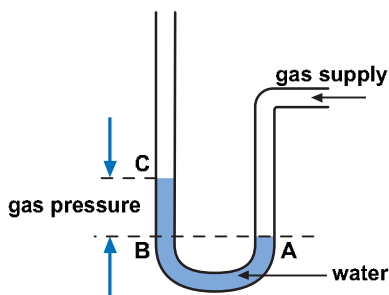


Figure 6.41 Using a manometer to measure the pressure of the gas supply

If one side of the manometer is connected to a system under pressure, the liquid will move. For example, if one end was connected to a gas supply the liquid would be pushed down as the supply is at a greater pressure than the surrounding atmosphere.

The height difference between B and C can then be used to determine the pressure of the gas supply.

- pressure of gas = atmospheric pressure + pressure due to the column of liquid BC
- pressure of gas =  $p_{atm} + h_{BC}\rho g$

For example, if a water-filled manometer was connected to a gas supply and the height difference (BC) was 9 cm the pressure of the gas would be:

- pressure of gas =  $p_{atm} + h_{BC}\rho g$
- pressure of gas =  $101\,000\text{ Pa} + 0.09\text{ m} \times 1000\text{ kg/m}^3 \times 10\text{ N/kg}$
- pressure of gas =  $101\,900\text{ Pa}$

This would most likely be expressed as a gauge pressure of 900 Pa.

### Forces in fluids

Objects seem less heavy in water. For example, it is easy to hold up a friend horizontally in a swimming pool. Try doing this in air!



Figure 6.42 A manometer being used



Figure 6.43 Despite their large mass elephants appear to be lighter underwater.

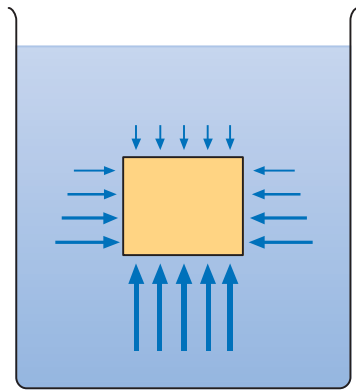
There is a force from the water that pushes you up, acting against gravity. This force is called a **buoyant force** (or sometimes **upthrust**). It arises due to the fact that as pressure increases with depth if you immerse an object in a fluid the pressure on the bottom will be greater than the pressure on the top.

This can be shown by considering the equation,  $p = h\rho g$ . The difference in pressure can be found by using:

- $\Delta p = \Delta h\rho g$

### Think about this...

If using a manometer to measure the pressure of higher pressure gases why is it a good idea to use mercury? Why is water usually used for gas supplies?



**Figure 6.44** The pressure is greater at a greater depth in water, so there is a bigger force on the lower surface of the block than on the upper surface.

This difference in pressure means there is a difference in force acting on the top and bottom of the object. The force on the bottom is greater and so there is net force upwards.

If you hold a cork underwater and then release it the buoyant force accelerates it towards the surface of the water. Equally if you drop a stone in the water it accelerates through the water much more slowly than it did through the air as the buoyant force means the net force acting on the stone is reduced.

The size of the buoyant force ( $F_b$ ) depends on a number of factors including the *density of the fluid* and the *volume of the object*.

Buoyant forces are not just limited to liquids. Air also provides a buoyant force but it is very small (as the density of air is much less than that of water). In order for it to have a significant effect the volume of the object must be huge. Hot air balloons ‘float’ in the air due to the buoyant force of the air pushing them up, acting against their weight.

### Apparent weight

As we mentioned earlier, objects immersed in water (or any liquid) appear to weigh less. Obviously their weight has not changed ( $w = mg$ ) but they now have an apparent weight. The buoyant force pushes upwards, acting against the objects weight and so the weight appears to drop.

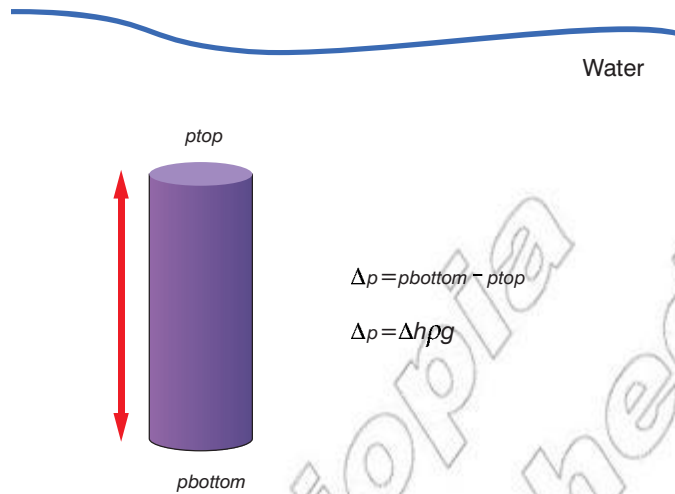
The apparent weight may be calculated using the equation below:

- apparent weight = weight – buoyant force

Gases (like air) also provide a buoyant force but it is usually too small to need thinking about.

This equation is more commonly used to determine the buoyant force acting on an object:

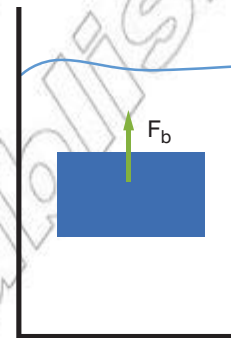
- buoyant force = weight – apparent weight



**Figure 6.45** The pressure difference =  $\Delta h\rho g$

$$\Delta p = p_{\text{bottom}} - p_{\text{top}}$$

$$\Delta p = \Delta h\rho g$$



**Figure 6.46** The pressure difference leads to a force acting vertically upwards.



**Figure 6.47** The buoyant force from the air keeps the hot balloon in the air.

### KEY WORDS

**buoyant force** a force from the water which pushes a body upwards against gravity

**upthrust** a force from the water which pushes a body upwards against gravity



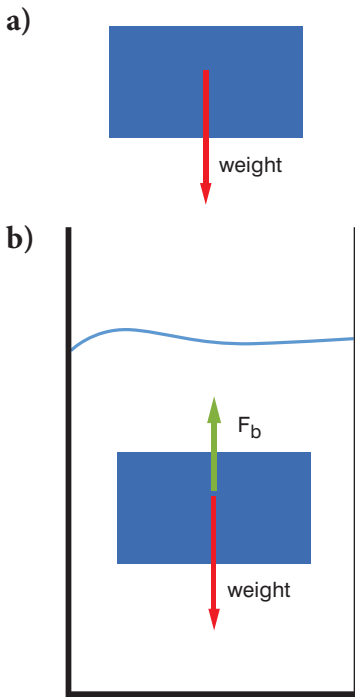


Figure 6.48 The forces acting on an object a) in air b) in water

Using a forcemeter we can easily determine the buoyant force acting on a stone (see Figure 6.49).

Here the buoyant force is equal to:

buoyant force = weight – apparent weight *State principle or equation to be used*

buoyant force = 6.0 N – 4.0 N *Substitute in known values and complete calculation*

buoyant force = 2.0 N *Clearly state the answer with unit*

### Archimedes's principle

You probably know the story of Archimedes in his bath. King Hiero had ordered a new gold crown, in the shape of a wreath of leaves. The crown was the correct weight, but he suspected that the jeweller had cheated him by mixing silver with the gold. Could Archimedes find a way of checking the crown without damaging it?

Archimedes was in his bath when he thought of the solution. As everyone knows, when you get in the bath, the water level rises because your body displaces some of the water. Archimedes, seeing how he could put this to use, leapt from the bath and ran down the street shouting 'Eureka!' which means 'I have it!'

Here is how Archimedes tested the crown. He put a weight of gold equal to the crown, and known to be pure, into a bowl which was filled with water to the brim. Then the gold was removed and the king's crown put in, in its place. This caused the bowl to overflow.

Archimedes was using the fact that gold is denser than silver, so it takes up less space. He found that the new crown had a greater volume than one made of pure gold. It was indeed a cheat, and the jeweller was punished.

Archimedes realised that when an object is immersed in a liquid it displaces a certain volume of the liquid.

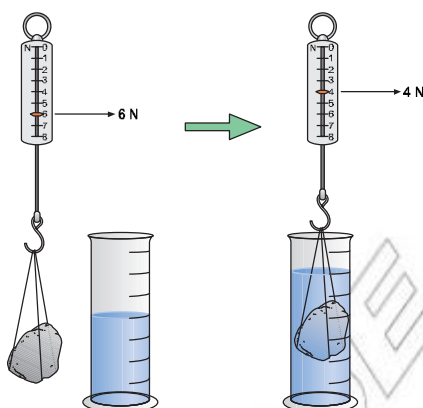


Figure 6.49 Measuring the buoyant force acting on a stone

#### KEY WORDS

**Archimedes's principle**  
principle stating that the weight of the fluid displaced by an object is equal to the buoyant force acting on it

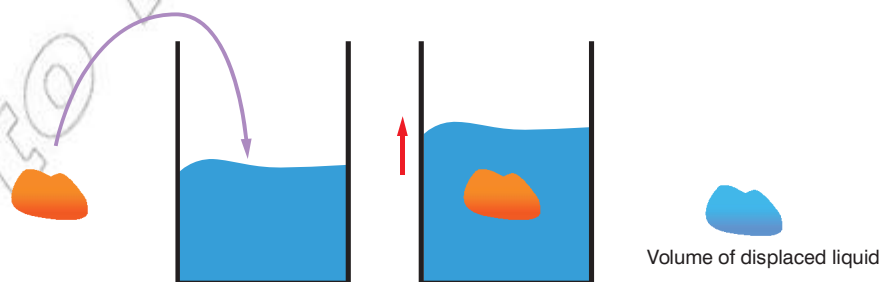


Figure 6.50 A stone placed in a beaker of water will cause the level of water to rise as it displaces its own volume.

He determined that the weight of the displaced fluid was equal to the buoyant force. Or in his own words:

- **Any object, wholly or partially immersed in a fluid, is buoyed up by a force equal to the weight of the fluid displaced by the object.**

In other words, the buoyant force acting on an object is equal to the weight of the displaced liquid.

- buoyant force = weight of displaced fluid

The greater the volume of liquid displaced the greater the buoyant force.

### Activity 6.14: Testing Archimedes's principle

Use thin thread to tie an object (a stone, metal weight or glass stopper is suitable) to the hook of a newtonmeter (a spring balance). Note its weight.

- Weigh a beaker.
- Place an overflow can on the bench and fill it with water. When no more water drips out of the can, place the weighed beaker under its spout (see Figure 6.51).
- Lower the object carefully into the water until it is partially immersed. Note the apparent weight of the object.
- Weigh the beaker with the displaced water in it.
- Replace the beaker and water under the spout. Lower the object into the can until it is totally immersed but not touching the bottom of the can. Note the apparent weight of the object.

- Weigh the beaker and the displaced water. You have to find the buoyant force on the object, and compare it with the weight of water displaced.

Upthrust = weight of object in air – weight of object in water

Weight of displaced water = weight of beaker with water – weight of empty beaker

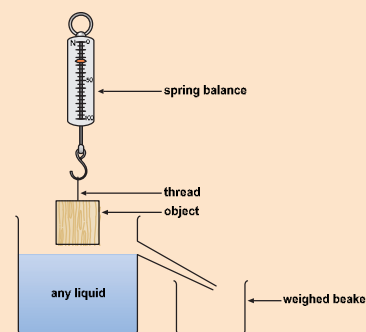


Figure 6.51 Testing Archimedes's principle

We can modify our equation for apparent weight in light of Archimedes' principle:

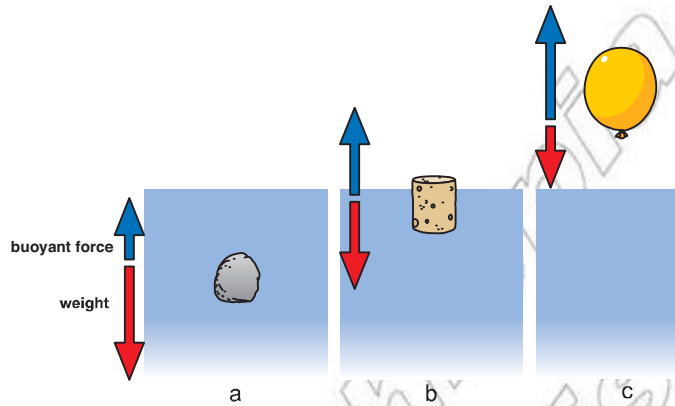
- apparent weight = weight – buoyant force
- buoyant force = weight of displaced fluid
- apparent weight = weight – weight of displaced fluid

**KEY WORDS**

**law of flotation** *law stating that if the buoyant force is equal to the weight of the object then the object will float*

**Floating and sinking**

Whether or not an object floats or sinks depends on the weight of the object and the size of the buoyant force acting on the object.



- a – weight is greater than buoyant force, so the stone sinks
- b – weight is equal to the buoyant force, so the cork floats
- c – weight is less than the buoyant force so the balloon rises

**Figure 6.52** *The relative sizes of the buoyant force and the weight determine whether an object will float or sink.*

In order to float an object must displace a volume of fluid (liquid or gas) equal to its own weight. This is called the **law of flotation**.

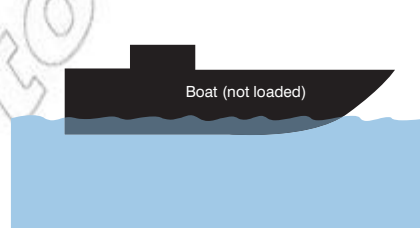
If the weight of the volume of fluid displaced is equal to the weight of the object then the object will float.

A large steel ship is able to float because it displaces such a large volume of water. This volume of water has the same weight as the ship.

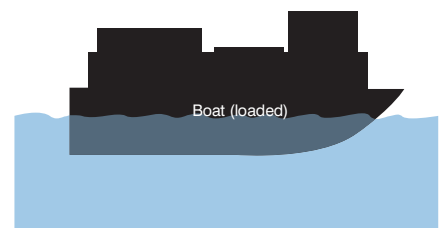


**Figure 6.53** *The ship floats due to the law of flotation.*

When you step into a small boat you might notice the boat sinks down a little in the water. This is because as the weight of the boat increases it needs to displace a greater volume of liquid in order to float, and so it sinks down lower in the water. A heavily loaded boat sits much lower in the water than a lightly loaded boat.



**Figure 6.54** *A boat that is not heavily loaded displaces a smaller volume of liquid in order to float.*



**Figure 6.55** *A boat that is heavily loaded needs to displace a much larger volume of water in order to float.*

In the late 19th century greedy ship owners were overloading their ships and several ships sank as a result. The Englishman Samuel Plimsoll developed the waterline (or more commonly the Plimsoll line). This was a line that by law must be painted on all large ships. For safety reasons, when the ship is fully loaded the level of the water must not be above the Plimsoll line.

### Worked example

A toy submarine has a weight of 6.2 N in air. When immersed in water it has a weight of 4.6 N. Determine the buoyant force and the weight of water displaced

buoyant force = weight – apparent weight *State principle or equation to be used*

buoyant force = 6.2 N – 4.6 N *Substitute in known values and complete calculation*

buoyant force = 1.6 N *Clearly state the answer with unit*

weight of displaced fluid = buoyant force *Make it clear the two quantities are equal from Archimedes's principle*

- weight of displaced fluid = 1.6 N *Clearly state the answer with unit*



Figure 6.56 The Plimsoll line on a ship

### Think about this...

If you look carefully at the image of the Plimsoll line you can see that there are several different lines depending on whether the ship is in fresh water, salt water, cold water (North Atlantic) or warm water (tropical). Why is this?

### What about density?

If, even when fully immersed, the weight of the volume of liquid displaced is less than the weight of the object, then the object will sink. A small cube of steel does not displace enough water to float. However, if you hammer out the steel into a bowl shape it displaces a greater volume of water and so will float.



Figure 6.57 The same mass of steel will sink or float depending on its shape and so the amount of fluid it displaces.

In other words, if the density of the object is greater than the density of the fluid it will sink.

This means we need to consider the relative density between the object and the liquid. If the relative density is less than one the object will float (as the weight of the object will be less than the weight of the volume of liquid it displaces). If the relative density is more than one the object will sink (as the weight of the object will be more than the weight of the volume of liquid it displaces). We can modify our previous equations to include the density of the object and the density of the fluid.

### Worked example

A floating wooden block has a volume of  $0.4 \text{ m}^3$  and displaces  $0.3 \text{ m}^3$  of water. Determine the density of the block.

$$\rho_{\text{object}} V_{\text{object}} = \rho_{\text{fluid}} V_{\text{fluid}} \quad \text{State principle or equation to be used (a version of Archimedes's principle)}$$

$$\rho_{\text{object}} = \rho_{\text{fluid}} V_{\text{fluid}} / V_{\text{object}} \quad \text{Rearrange equation to give } \rho_{\text{object}}$$

$$\rho_{\text{object}} = (1000 \text{ kg/m}^3 \times 0.3 \text{ m}^3) / 0.4 \text{ m}^3 \quad \text{Substitute in known values and complete calculation}$$

$$\rho_{\text{object}} = 750 \text{ kg/m}^3 \quad (\text{or a relative density of } 0.75) \quad \text{Clearly state the answer with unit}$$

- $w = mg$  and  $\rho = m / V$
- weight of object =  $m_{\text{object}} g$  and so weight of object =  $\rho_{\text{object}} V_{\text{object}} g$
- weight of displaced liquid =  $m_{\text{fluid}} g$  and so weight of displaced fluid =  $\rho_{\text{fluid}} V_{\text{fluid}} g$

If the object is floating then:

- buoyant force = weight of displaced liquid = weight of object

So:

$$\rho_{\text{object}} V_{\text{object}} g = \rho_{\text{fluid}} V_{\text{fluid}} g$$

The  $g$ 's cancel, giving:

$$\rho_{\text{object}} V_{\text{object}} = \rho_{\text{fluid}} V_{\text{fluid}}$$

This equation only applies if the object is floating.

## Summary

In this section you have learnt that:

- A fluid is any substance that can flow. This includes gases as well as liquids.
- Gases may be compressed but liquids are incompressible.
- Density is defined as the mass per unit volume and it may be calculated using the equation  $\rho = m / V$ . Density is measured in  $\text{kg/m}^3$ .
- The relative density of a substance is the density of the substance compared to another (e.g. compared to water).
- In fluids the pressure increases with depth and is the same in all directions.
- In fluids the pressure due to the fluid is equal to  $p = h\rho g$ . The total pressure is equal to the pressure due to the fluid plus atmospheric pressure.
- Pascal's principle states that liquids transfer pressure from one place to another without any reduction in pressure.
- Gauge pressure is the difference between absolute pressure and atmospheric pressure.
- A manometer is a simple U-shaped tube filled with liquid used to measure pressure.
- The apparent weight of a body is equal to the weight of the object minus the buoyant force acting on it.
- Archimedes's principle states that the weight of the displaced fluid is equal to the buoyant force acting on the object.
- The principle of flotation states if the buoyant force (or weight of displaced fluid) is equal to the weight of the object then the object will float.
- If the object is floating then the density of the floating object can be calculated from:  $\rho_{\text{object}} V_{\text{object}} = \rho_{\text{fluid}} V_{\text{fluid}}$  where  $V_{\text{fluid}}$  is the volume of the displaced fluid.

## Review questions

1. Explain what is meant by the term fluid and give three examples.
2. Calculate the pressure caused by sea water when diving to a depth of 100 m. What is the total pressure acting on the diver?
3. State Pascal's principle and describe one of its applications.

4. Two pistons are connected together to make a hydraulic lift. The smaller piston has an area of  $0.05 \text{ m}^2$  and the larger piston has an area of  $2 \text{ m}^2$ . Calculate the following:
  - a) The pressure in the fluid and the force at the larger piston if the force on the smaller piston is  $50 \text{ N}$ .
  - b) The pressure in the fluid and the force from the smaller piston required to lift a car of mass  $1200 \text{ kg}$ .
5. Describe the relationship between the buoyant force and the weight of an object if the object:
  - a) is floating
  - b) is sinking
  - c) is rising up through the water.

### End of unit questions

1. An elephant has a mass of  $3200 \text{ kg}$ . Each of its feet covers an area equal to  $0.08 \text{ m}^2$ . Calculate the pressure from each foot.
2. Describe what causes pressure in gases in terms of the particles in the gas.
3. Describe some similarities and difference between liquids and gases.
4. How deep under water would you need to be in order to be at double atmospheric pressure?
5. Explain the meaning of the terms atmospheric pressure, absolute pressure and gauge pressure.
6. Describe the use of a manometer and calculate the pressure of a gas supply that causes a column of water  $15 \text{ cm}$  high.
7. State Archimedes's principle and explain how this leads to the law of flotation.
8. Explain why a heavily loaded boat sinks lower in the water.
9. The weight of an object is measured in air to be  $7.0 \text{ N}$ . The object is then immersed in water and its apparent weight is measured to be  $4.0 \text{ N}$ . Determine the buoyant force and state whether or not the object floats.
10. A large ocean liner floating in the sea has a volume of  $375\,000 \text{ m}^3$  and displaces  $50\,000 \text{ m}^3$  of sea water. Determine the density and mass of the ship. Explain why, despite being made of metal, the ship is able to float.

Contents	
Section	Learning competencies
7.1 Temperature and heat (page 172)	<ul style="list-style-type: none"> <li>• Explain the difference between heat and temperature.</li> <li>• Define the term thermal equilibrium.</li> </ul>
7.2 Expansion of solids, liquids and gases (page 179)	<ul style="list-style-type: none"> <li>• Describe the thermal expansion of solids and derive the expression for the linear and surface expansion of solids.</li> <li>• Find the relationship between the coefficient of linear, area and volume expansion and solve related problems.</li> <li>• Know applications of the thermal expansion of materials.</li> <li>• Distinguish between apparent and real expansion of a liquid and solve problems involving the expansion of liquids using <math>V = V_0\gamma\Delta T</math>.</li> <li>• Explain the abnormal expansion of water.</li> <li>• Compare the expansion of gases with the expansion of solids and liquids.</li> </ul>
7.3 Quantity of heat, specific heat capacity and heat capacity (page 191)	<ul style="list-style-type: none"> <li>• Describe the factors that affect the amount of heat absorbed or liberated by a body.</li> <li>• Define the terms specific heat capacity and heat capacity and calculate the amount of heat energy absorbed or liberated by a body using <math>Q = mc\Delta T</math>.</li> <li>• Calculate the heat capacity of a body.</li> <li>• Identify different units of heat energy.</li> <li>• Explain the significance of the high specific heat capacity of water.</li> <li>• Use the relationship heat lost = heat gained to solve problems involving heat exchange.</li> <li>• Describe the uses of a calorimeter.</li> </ul>
7.4 Changes of state (page 199)	<ul style="list-style-type: none"> <li>• Define the terms latent heat, latent heat of fusion and latent heat of vaporisation.</li> <li>• Solve problems involving change of state.</li> </ul>

On a hot day our ice cream melts more quickly, but why? On a cold day we may need a coat and if it gets very cold it might even snow. Our perception of temperature is all relative; what's cold to us might be described very differently from a resident of northern Canada!

The concepts of heat and temperature are not just used in weather forecasting. The bread in an oven needs to be baked at just the right temperature, the wheels are fitted onto a train's axle using low temperatures in a technique called shrink fitting, and air conditioning and central heating systems only function due to our understanding of heat and temperature.

This unit looks at the meaning of the terms heat and temperature, the effects of different temperatures and some applications that rely on these phenomena.



**KEY WORDS**

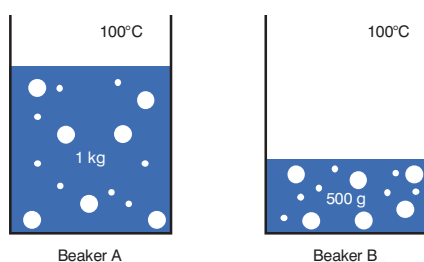
**atoms** the smallest parts of a chemical element that can take part in a reaction

**average kinetic energy** the mean kinetic energy of all the particles in a substance

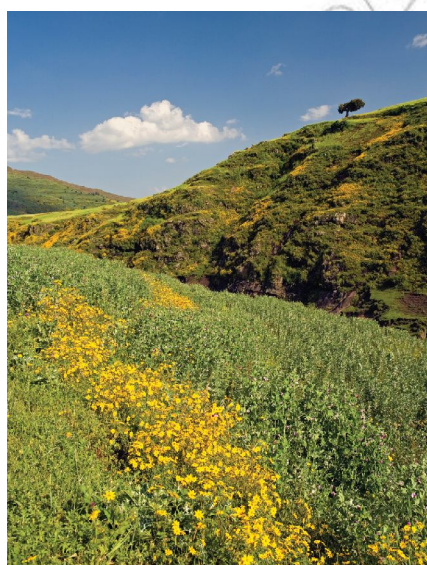
**ions** an atom or group of atoms that has acquired an electrical charge by gaining or losing one or more electrons

**molecules** the smallest unit of a substance, consisting of a group of atoms, which retains the chemical and physical properties of the substance

**particles** small units of matter such as atoms, ions and molecules



**Figure 7.1** Two beakers of boiling water



**Figure 7.2** A hot day. But what is the difference between heat and temperature?

## 7.1 Temperature and heat

By the end of this section you should be able to:

- Explain the difference between heat and temperature.
- Define the term thermal equilibrium.

### What is heat?

When we cook food, we might say we are heating it up. The temperature of the food increases. It seems like heat and temperature are the same thing, but they are not!

We already know that matter is made up of moving **particles** (**molecules, atoms** and **ions**). In solids these particles are tightly bonded together and so they can only vibrate, whereas in fluids (liquids and gases) the particles can move around more freely.

Heat is one form of energy; it is therefore measured in joules and is a *scalar* quantity. Heat is a flow of energy from hotter regions to colder ones.

$$Q = \Sigma E_k + \Sigma U$$

$Q$  is the symbol used for heat energy. From Unit 4,  $E_k$  is kinetic energy and  $U$  is potential energy. Remember,  $\Sigma$  means sum of.

Imagine two beakers of boiling water. Beaker A contains 1 kg of boiling water and beaker B contains 0.5 kg of boiling water. They are both at the same temperature, 100 °C, but there are more particles in beaker A and so there is more energy contained within it than with beaker B.

When we heat up a substance, we are transferring energy to the substance. This means one of two things could happen.

- **The particles of the substance gain kinetic energy and so move more rapidly.**

and/or

- **The bonds between the particles in the substance are broken and the potential energy of the particles increases. When this happens, the substance changes state.**

### What is temperature?

Temperature is a measure of ‘hotness’. The higher the temperature, the hotter the object. The complication is that ‘hotter’ may not mean more heat when comparing two objects.

The temperature of a substance is a measurement of the **average kinetic energy** of the particles within the substance. If the particles in a substance have a higher average kinetic energy then the object is at a higher temperature. That is to say if the particles are, on average, moving faster then the object is at a higher temperature. The water molecules in a glass of water at 50 °C are, on average, moving faster than those in a glass at 20 °C.

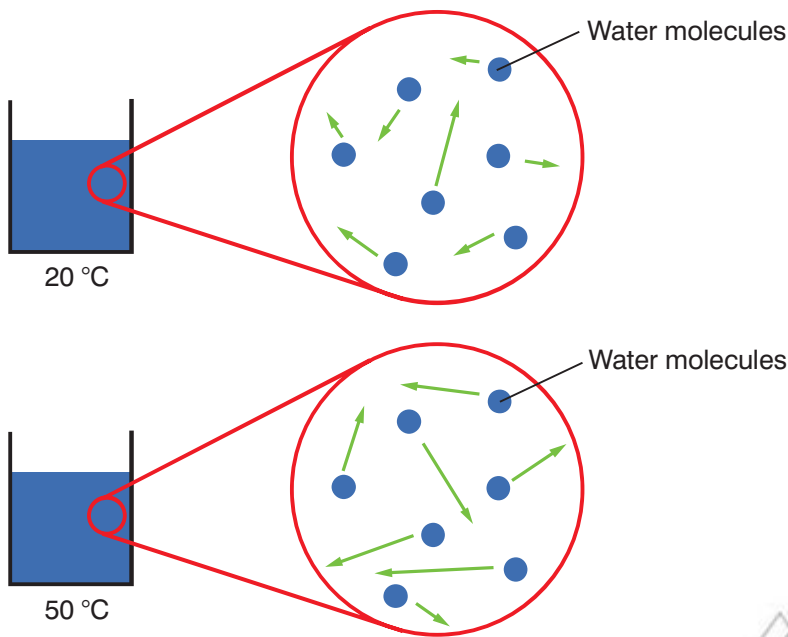


Figure 7.3 On average, the particles are moving faster if the object is at higher temperature.

10 kg of water at room temperature may contain more energy than a tiny metal spark from a sparkler. However, the spark is at higher temperature (maybe 500 °C compared with 25 °C). Temperature is a measure of the average kinetic energy of the particles; heat is the total thermal energy inside the substance (the total kinetic and potential energies added together). On average, the particles are moving faster in the spark; however, there are far more particles in the water, all with a kinetic energy and potential energy.

It is important to notice we use the average kinetic energy. In any substance some particles will be moving faster than others and so these particles will have more kinetic energy than the others.

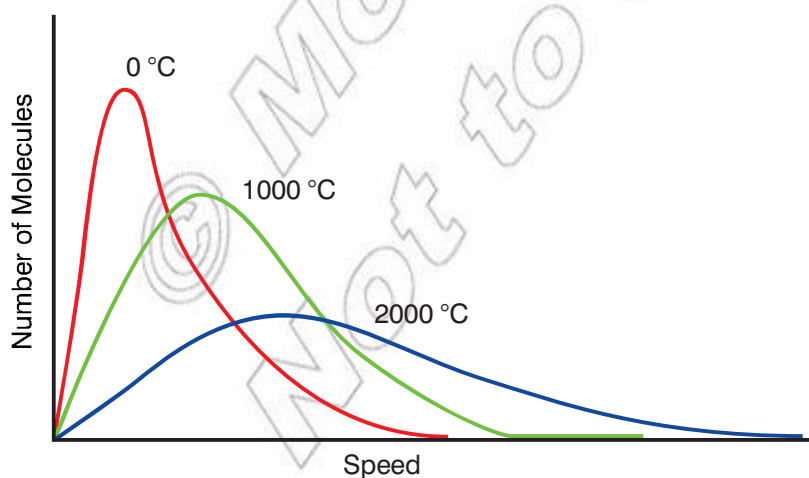


Figure 7.5 This graph shows how many particles have a given speed at three different temperatures.



Figure 7.4 The water may contain more heat energy even though it is at a lower temperature than the spark.

### Think about this...

As the temperature of a body indicates the average kinetic energy of the particles, it *does not* depend on the number of particles present.

**DID YOU KNOW?**

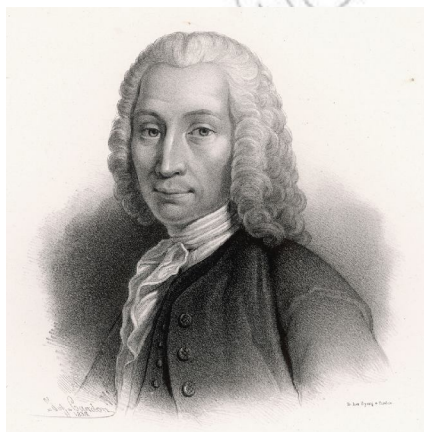
At room temperature all gases will have the same average kinetic energy. This means the lower mass gas particles are, on average, travelling faster. One of the reasons there is very little helium in the atmosphere is because they are so light a significant number of helium atoms are going fast enough to escape the Earth's gravitational pull and float off into space. The heavier gases, like oxygen, nitrogen and carbon dioxide are on average moving slower and so don't escape.

**KEY WORDS**

**absolute zero** *the temperature at which a substance has no thermal energy*

**Celsius scale** *a temperature scale where the freezing point of water is fixed at 0 degrees and the boiling point at 100 degrees C*

**Kelvin scale** *a temperature scale that uses absolute zero as one of its fixed points*



**Figure 7.7** The Swedish astronomer Anders Celsius first proposed the Celsius scale in 1742.

If we look at Figure 7.5, we can see that at 0 °C, most particles have a relatively low speed and hence a relatively low kinetic energy – only a relatively small number of particles have a high speed and a high kinetic energy. As a substance is heated to a higher temperature, for example 1000 °C, the graph shows us that the average speed and consequently average kinetic energy of the particles is greater than at 0 °C.

**Temperature scales**

A range of temperature scales have been used in the past, though scientists now tend to deal with the **Kelvin scale** (K) or the **Celsius scale** (°C). The Fahrenheit scale (°F) is still used by the United States but is rarely used by the scientific community.

To design a temperature scale two fixed reference points have to be used. The scale is then based on these points with a certain number of jumps in between them.

For example, in the Celsius scale, the freezing point of water is given as 0 °C, with the second fixed point being the boiling point of water – the difference between the two fixed points is divided into 100 equal divisions so the boiling point of water is 100 °C.



**Figure 7.6** The freezing point and boiling point of water were the two fixed points used on the Celsius scale.

The Kelvin scale uses **absolute zero** as one of its fixed points. This is the temperature at which a substance will have no thermal energy and it is not possible to get a lower temperature (0 K or  $-273.15$  °C). The Kelvin scale has a units symbol of K; there is no degree symbol included.

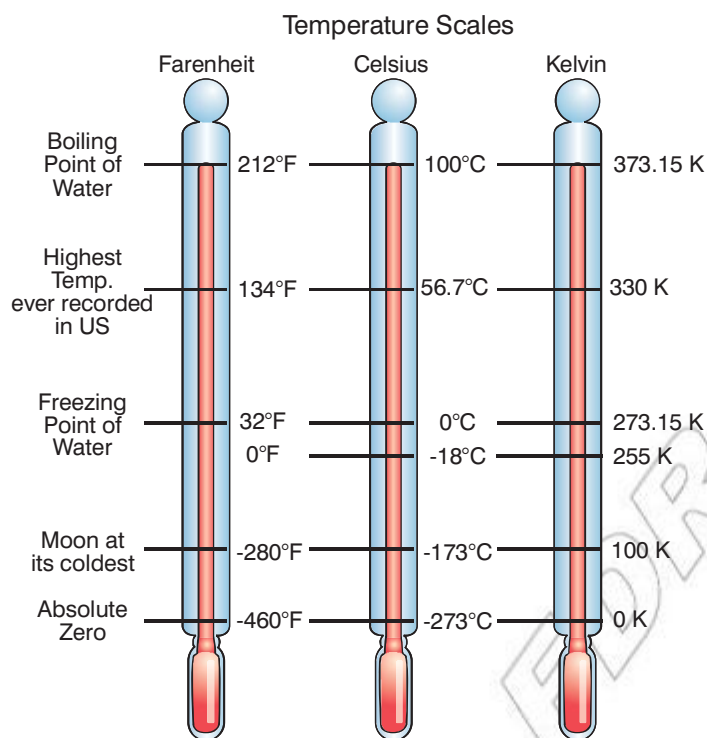
The Kelvin and the Celsius scales are often used together as they have the same scale division. This means a *change* of 20 K is the same as a change of 20 °C.

The Kelvin scale may seem unusual as it uses fixed points that we are not familiar with but, importantly, temperatures measured in the Kelvin scale are directly proportional to the average kinetic energy of the particles present. For example, the particles in a block

of iron have on average twice as much kinetic energy at 200 K than at 100 K.

The Fahrenheit scale uses one fixed point as the temperature of an ice, water and ammonium chloride mixture ( $0^{\circ}\text{F}$ ) – the second fixed point is normal body temperature ( $98^{\circ}\text{F}$ ).

The diagram in Figure 7.8 shows how these temperature scales compare. We will use the Celsius and Kelvin scale in our calculations.

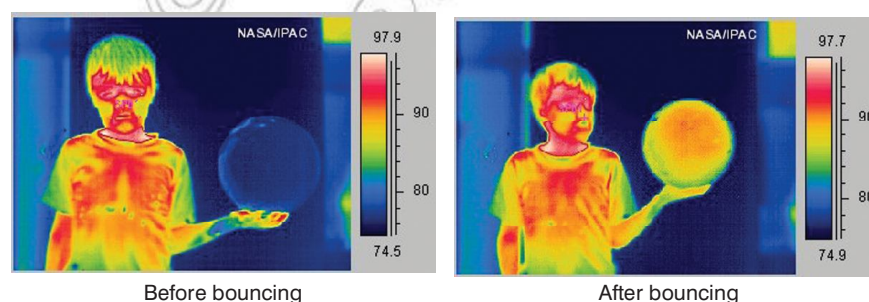


**Figure 7.8** Comparing different temperature scales

### A bouncing ball

If a ball is bounced repeatedly, it gains heat energy and its temperature increases. The photographs in Figure 7.9 show thermal images of a ball before and after the ball is bounced. The higher temperatures are shown progressively in red, orange, and yellow; green and blue indicate lower temperatures

Look at the temperature scales down the side of the photos – what temperature scale do you think is being used and where has the heat energy come from to increase the temperature of the ball?



**Figure 7.9** Bouncing a ball will increase its temperature.

### DID YOU KNOW?

The Celsius scale is named after the Swedish astronomer Anders Celsius. In 1742 he proposed the Celsius temperature scale, with one key difference. He set his lower fixed point (the freezing point of water) as  $100^{\circ}\text{C}$  and the boiling point as  $0^{\circ}\text{C}$ . This meant using his scale the number got smaller as the substance got hotter! The scale was reversed the year after he died.

### Think about this...

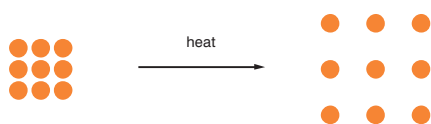
At absolute zero a substance will have zero internal energy. What does this tell you about the kinetic energies and potential energies of the particles? Do you think it will be possible to reach absolute zero?

### DID YOU KNOW?

The place that has the world's highest average temperature is Dalol, Ethiopia, in the Danakil Depression. The average temperature is an almost unbelievable  $35^{\circ}\text{C}$ , or  $308\text{ K}$ .

### Activity 7.1: Temperature scales

How would you convert a temperature recorded on the Celsius scale into a temperature on the Kelvin scale (K) and vice versa?



**Figure 7.10** As the particles vibrate more they spread out and so the substance expands.



**Figure 7.11** A and B are in thermal contact. A is hotter than B; it has a higher temperature.

## What happens when a substance absorbs heat energy?

As a substance absorbs heat energy, the particles vibrate more (in a solid) or move faster (in a liquid or gas) as the heat energy is converted into the kinetic energy of the particles as the temperature rises. As the particles gain more energy, we can see that they move further apart from each other, which means the substance will **expand** (increase in size).

The diagram in Figure 7.10 shows how the particles in a solid move further apart as the solid is heated.

The expansion of substances on heating is called **thermal expansion**. This happens in solids, liquids and gases. We will deal with this in more detail in Section 7.3.

## Thermal equilibrium

**Heat energy flows from a hotter body to a colder body.** Place your hand near an oven and you can feel the heat energy flowing into our hand. It feels hot! Place your hand inside a fridge and the heat energy flows from you into the fridge, it feels cold. An ice cube in boiling water will absorb heat energy from the hotter water, but the same ice cube in deep space will radiate heat energy to its surroundings.

When there is a movement of heat energy from a hotter object to a colder object, we say that the two objects are in **thermal contact**. Objects in thermal contact do not have to be in physical contact but they could be touching each other. So, we would say that the ice cube and the boiling water are in thermal contact with each other.

Imagine that we have two objects, A (at 90 °C) and B (at 50 °C). A and B are in thermal contact. There will be a *net* flow of heat energy will flow from A to B.

As heat energy is lost from A, the particles in A will slow down. They have, on average, less kinetic energy and so the temperature of A will decrease. The opposite happens at B. As B gains heat energy, the particles in B move faster, their average kinetic energy will increase and so the temperature of B rises.

This process of heat loss from A and heat gain by B will go on until A and B both reach the same temperature. At this point, **thermal equilibrium** is reached (heat loss from A will equal heat gained by B so that there is no net movement of heat energy between the two bodies).

- **If two bodies are in thermal equilibrium, they will also be at the same temperature.**

The details of how two bodies in thermal contact obtain thermal equilibrium are governed by the first and second laws of thermodynamics.

### Think about this...

The concept of thermal equilibrium allows us to measure temperature. Imagine our object B is a thermometer; what temperature will the thermometer read when it is at thermal equilibrium with object A? Will this temperature be *exactly* the same as the original temperature of A?

## First law of thermodynamics

The first law of thermodynamics has more than one form but all are really different ways of saying the same thing. It is essentially the **law of conservation of energy**; that is, that energy cannot be created or destroyed but can be transformed into other forms.

Imagine a gas that has a certain internal energy (the sum of the gas particles' kinetic and potential energy). The increase in internal energy of the gas,  $\Delta U$ , will be equal to the heat energy it has gained,  $\Delta Q$ , plus any work done on the gas,  $\Delta W$  (for example if it is compressed).

- $\Delta U = \Delta Q + \Delta W$
- $\Delta U$  = change in internal energy in J
- $\Delta Q$  = heat energy *added* to system in J
- $\Delta W$  = work done *on* system in J

Notice in this case  $\Delta U$  is the internal energy of the gas. Even though it is the sum of the kinetic and potential energies of the particles in the gas it is essentially a potential (stored) energy in the gas, hence the symbol  $U$ . All these terms are energies and so measured in joules.

We can see from the equation that if no work is done ( $\Delta W = 0$ ), the heat energy we add to the object will equal the increase in internal energy. This means the temperature of the object will rise. In other words, energy has not been created or destroyed, just transformed into other forms.

We can also increase the internal energy by doing work on the substance. Imagine the gas inside a pump. If we rapidly compress the pump with our thumb over the end we are doing work **on** the gas inside it. In this case the work goes into increasing the internal energy of the gas. The gas gets hotter.

The equation may be used to calculate the change in internal energy, if there is work being done and there is a flow of heat into a substance.

For example, consider a gas that is being heated and compressed. There is a heat flow into the gas of 500 J and 200 J of work is done on the gas by compressing it. The change in internal energy is:

$$\Delta U = \Delta Q + \Delta W \quad \text{State principle or equation to be used (First law of thermodynamics)}$$

$$\Delta U = 500 \text{ J} + 200 \text{ J} \quad \text{Substitute in known values and complete calculation}$$

$$\Delta U = 700 \text{ J} \quad \text{Clearly state the answer with unit}$$

However, what if the object is hotter than its surroundings? Imagine a cup of tea. If you stir it really fast you might do 20 J of work on the tea. At the same time there has been a flow of heat from the tea to the surroundings of 100 J. What is the change in internal energy?

$$\Delta U = \Delta Q + \Delta W \quad \text{State principle or equation to be used (First law of thermodynamics)}$$

$$\Delta U = -100 \text{ J} + 20 \text{ J} \quad \text{Substitute in known values and complete calculation}$$

$$\Delta U = -80 \text{ J} \quad \text{Clearly state the answer with unit}$$



**Figure 7.12** Heating or doing work on a gas increases its internal energy and so its temperature.

### DID YOU KNOW?

There is also a zeroth law of thermodynamics, which states that if object A and B are individually in thermal equilibrium with another object C, objects A and B are also in thermal equilibrium with each other. This law has important implications – it means that if C is our thermometer, it will indicate the same temperature for both objects A and B.

### KEY WORDS

**expand** *to increase in size*

**thermal contact** *when there is a movement of heat energy between a hotter and a colder object*

**thermal expansion** *the increase in size of a substance as a result of heating*

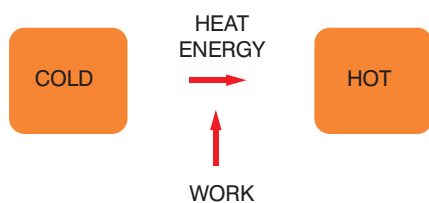
**thermal equilibrium** *situation where there is no net movement of heat energy between bodies*



**Figure 7.13** Doing work on a cup of tea as heat flows from the cup to the surroundings.



**Figure 7.14** There is a net energy flow from hotter to colder objects.



**Figure 7.15** Energy will flow from colder to hotter objects if work is done on the system.



**Figure 7.16** In a fridge heat flows from inside the fridge to its surroundings even though it is at a lower temperature.

In this case the tea has lost 100 J to the surrounds so  $\Delta Q = -100$  J. The overall change in internal energy is  $-80$  J, so the tea's temperature will fall. Theoretically it is possible to stir it fast enough to keep the tea at the same temperature. In which case  $\Delta U = 0$  J and so  $\Delta Q = -\Delta W$ , but you would have to stir it very fast!

## Second law of thermodynamics

The second law of thermodynamics concerns the direction of heat flow between two bodies. Usually, as we have seen when we looked at thermal equilibrium, heat energy flows spontaneously from hotter objects to colder objects. The second law of thermodynamics might be expressed as:

- **Heat generally cannot flow spontaneously from a material at lower temperature to a material at higher temperature.**

Heat energy will not flow from a colder object to a hotter one spontaneously unless work is done. Energy must be used to reverse the usual flow of heat energy. This principle is used in refrigerators, freezers and air conditioning units. The contents of a fridge are cooled by a liquid evaporating, but work has to be put in so as to condense the gas for further use.

## Summary

In this section you have learnt that:

- Heat is energy transferred from hotter regions to cooler ones.
- The temperature of a substance is an indication of the average kinetic energy of the particles and the Celsius and Kelvin scales are both temperature scales.
- On heating, the particles of a substance move faster and move further apart so that a substance expands on heating.
- The first law of thermodynamics states that during heat transfer processes, energy cannot be created or destroyed.
- The second law of thermodynamics states that heat energy will flow from hot objects to colder objects and that if work is put in, heat energy can be removed from a cold object.
- When bodies are in thermal contact, heat energy flows from hot objects to cold objects until thermal equilibrium is reached and the bodies are at the same temperature.

## Review questions

1. What will be the key difference in the energy of the particles in iron at 250 K and 500 K?
2. Explain why a solid expands on heating.

3. Describe what happens, in terms of the movement of heat energy, when a hot object is in thermal contact with a cold object. Explain how this process could be reversed.
4. Convert the following temperatures to the Kelvin scale:
  - a)  $-273.15\text{ }^{\circ}\text{C}$
  - b)  $0.0\text{ }^{\circ}\text{C}$
  - c)  $1000\text{ }^{\circ}\text{C}$ .

## 7.2 Expansion of solids, liquids and gases

By the end of this section you should be able to:

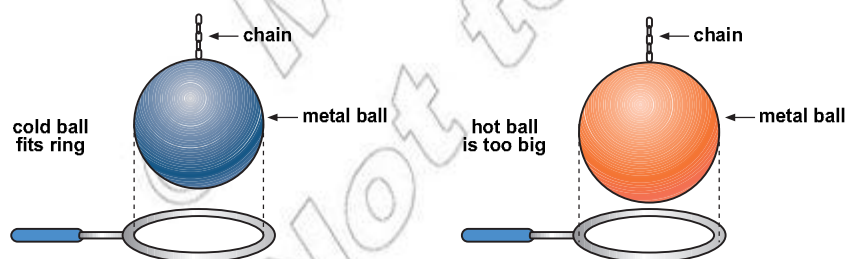
- Describe the thermal expansion of solids.
- Derive the expression for the linear and surface expansion of solids.
- Find the relationship between the coefficient of linear, area and volume expansion and solve related problems.
- Know applications of the thermal expansion of materials.
- Distinguish between apparent and real expansion of a liquid.
- Solve problems involving the expansion of liquids using  $V = V_0 \gamma \Delta T$ .
- Explain the abnormal expansion of water.
- Compare the expansion of gases with the expansion of solids and liquids.

### KEY WORDS

**substance** material or matter

### The expansion of solids

We have already seen that when a solid is heated, its particles move further apart and hence the solid expands (increases in size). The ball and ring experiment shown in Figure 7.17 is a good demonstration of the expansion of a solid.



**Figure 7.17** The hoop and ball experiment.

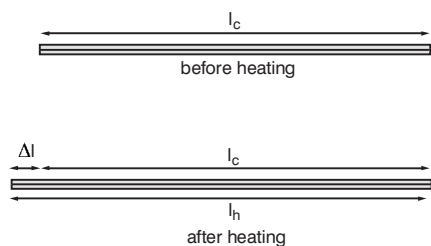
The cold metal ball easily passes through the ring. After heating, the metal ball expands and it is no longer able to pass through the ring.

How much a solid expands on heating will depend on the **substance** and how much its temperature increases.



**Figure 7.18** When Concorde flew at over twice the speed of sound, it got so hot that it increased its 61.6 m length by about 30 cm.





**Figure 7.19** Linear expansion of a narrow metal rod.

### KEY WORDS

**coefficient of linear expansion** the increase in length of a 1 m rod of given substance when its temperature increases by 1 K

**linear expansion** the increase in length of a substance due to heating

## Linear expansion of solids

When a metal rod is heated it expands and increases in length. This expansion is referred to as **linear expansion**. The diagram in Figure 7.19 shows a metal rod, of length  $l_c$  (measured in metres), before and after heating.

The rod's temperature has increased by  $\Delta T$ . It increases in length on heating; the increase in length,  $\Delta l$ , is the difference between the length before heating,  $l_c$ , and the length after heating,  $l_h$ . This could be written as:

$$\bullet \Delta l = l_h - l_c$$

So, for an increase in temperature of  $\Delta T$ , the fractional increase in length =  $\Delta l/l_c$ . If a 50 cm rod expanded by 2 cm the fractional expansion would be:

- fractional increase =  $\Delta l/l_c$
- fractional increase =  $2/50$
- fractional increase =  $1/25$  or 0.04

The fractional increase in length per unit of temperature ( $^{\circ}\text{C}$  or  $\text{K}$ ) increase is given the symbol  $\alpha$ . It is found by dividing the fractional increase by the increase in temperature,  $\Delta T$ .

$$\bullet \alpha = \Delta l/l_c/\Delta T$$

Which is the same as:

$$\bullet \alpha = \Delta l/l_c \Delta T$$

$\alpha$  is also known as the **coefficient of linear expansion for the solid**. It represents the increase in the length of a 1 m rod of a given substance when its temperature increases by 1 K. It is measured in  $1/\text{K}$  or  $\text{K}^{-1}$ .

So, the increase in length of a heated rod,  $\Delta l$ , can be found by rearranging the above equation.

$$\bullet \Delta l = \alpha l_c \Delta T$$

The values for the linear expansion coefficient of some solids are shown in Table 7.1.

**Table 7.1** The linear expansion coefficients of some solids

Substance	Linear expansion coefficient ( $\times 10^{-5} \text{ K}^{-1}$ )
aluminium	2.3
copper	1.7
brass	1.9
iron	1.1
concrete	1.2

This means that a 1 m iron rod will expand by  $1.1 \times 10^{-5} \text{ m}$  for every 1 K rise in temperature. With these values, we can now calculate the increase in length of a material.

### Worked example

Calculate the increase in length of a 50 cm brass rod that is heated from 25 °C to 70 °C.

$$\Delta l = \alpha l_c \Delta T \text{ Express } \Delta l \text{ in terms of known factors}$$

In this case  $l_c = 0.50 \text{ m}$  and  $\Delta T = 70 \text{ °C} - 25 \text{ °C} = 45 \text{ °C}$

$$\Delta l = 1.9 \times 10^{-5} \text{ K}^{-1} \times 0.50 \text{ m} \times 45 \text{ °C} \text{ Substitute in known values and complete calculation}$$

$$\Delta l = 4.3 \times 10^{-4} \text{ m} \text{ Clearly state the answer with unit}$$

Calculate the length of an iron rail at 400 °C, when it is exactly 100 m long at 200 °C.

$$\Delta l = \alpha l_c \Delta T \text{ Express } \Delta l \text{ in terms of known factors}$$

In this case  $l_c = 100 \text{ m}$  and  $\Delta T = 400 \text{ °C} - 200 \text{ °C} = 200 \text{ °C}$

- $\Delta l = 1.1 \times 10^{-5} \text{ K}^{-1} \times 100 \text{ m} \times 200 \text{ °C}$  Substitute in known values and complete calculation

- $\Delta l = 0.22 \text{ m}$  Clearly state the answer with unit

Therefore, length of rail at 400 °C = 100 m + 0.22 m = 100.22 m  
Ensure new length is calculated not just left as  $\Delta l$

### Activity 7.2: Expansion calculations

Calculate the increase in length of a 27 cm brass rod that is heated from 10 °C to 100 °C.  $\alpha_{\text{brass}} = 1.9 \times 10^{-5} \text{ K}^{-1}$ .

Calculate the length of a concrete section of a bridge at 45.00 °C, when it is 25.000 m long at 18.00 °C.  $\alpha_{\text{concrete}} = 2.2 \times 10^{-5} \text{ K}^{-1}$ .

### Think about this...

Why do you think that it is safe to build a bridge made out of concrete reinforced with iron?

### Surface (area) expansion of solids

In the examples we have looked at in linear expansion, the sample has been long in comparison to its height and width, so that the only significant expansion is in length. In practice, many objects are not long and thin and we need to develop a strategy to deal with these objects. We will start by looking at the expansion, in two dimensions, of a metal plate.



before heating  
surface area =  $A_c$

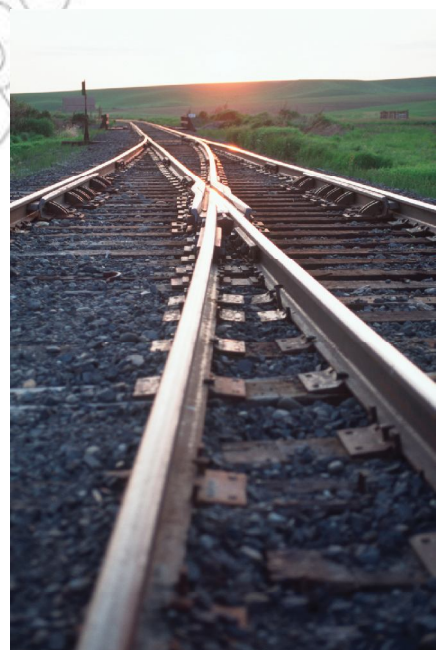


after heating  
surface area =  $A_h$

**Figure 7.21** Two-dimensional expansion of an object

As the plate is heated to cause an increase in temperature,  $\Delta T$ , it expands in width and height such that the surface area when heated,  $A_h$ , is larger than the original surface area,  $A_c$ . So:

- $\Delta A = A_h - A_c$

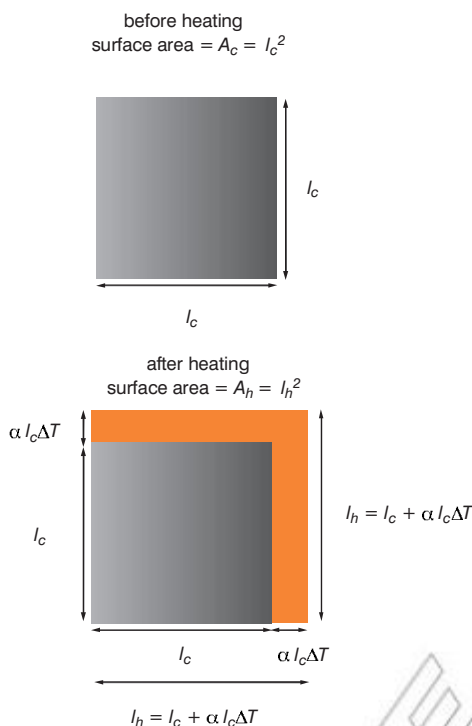


**Figure 7.20** It is very important to consider the surrounding temperature and temperature variations when laying train tracks.

**Activity 7.3: Surface area expansion**

Calculate the increase in surface area of an iron drain cover with a surface area of  $0.75 \text{ m}^2$  at  $20 \text{ }^\circ\text{C}$ , when it is heated to a temperature of  $53 \text{ }^\circ\text{C}$ .

$$\beta_{\text{iron}} = 2.2 \times 10^{-5} \text{ K}^{-1}$$



**Figure 7.22** Relating linear expansion to surface expansion

The fractional increase in surface area,  $\beta$ , per unit rise in temperature ( $^\circ\text{C}$  or  $\text{K}$ ) is given by:

- $\beta = \Delta A / A_c \Delta T$
- $\Delta A = \beta A_c \Delta T$

**What is the relationship between  $\alpha$  and  $\beta$  for a given substance?**

We will start by recalling what  $\beta$ , the surface expansion coefficient, means and rewriting the expression:

- $\beta = \Delta A / A_c \Delta T$
- $\beta = A_h - A_c / A_c \Delta T$

Therefore:

- $\beta A_c \Delta T = A_h - A_c$

Making  $A_h$  the subject of the equation:

- $A_h = \beta A_c \Delta T + A_c$

which, after simplifying, gives:

- $A_h = A_c (1 + \beta \Delta T)$  – this expression will be of use later.

We will now write another expression for  $A_h$ , in terms of  $\alpha$ , the linear expansion coefficient. If a square body of length  $l_c$  is heated such that its temperature increases by  $\Delta T$ , each side increases in length,  $\Delta l$ , by  $\alpha l_c \Delta T$  (see the section on linear expansion).

Consequently, the surface area of the heated body, is give by  $A_h = l_h^2$ .

$l_h$ , the length of each side of the heated body is related to  $l_c$ :

- $l_h = l_c + \alpha l_c \Delta T$

Consequently,

- $A_h = l_h^2 = (l_c + \alpha l_c \Delta T)^2 = l_c^2 (1 + \alpha \Delta T)^2 = l_c^2 (1 + 2\alpha \Delta T + \alpha^2 \Delta T^2)$
- $A_h = l_c^2 (1 + 2\alpha \Delta T + \alpha^2 \Delta T^2)$

We can further simplify this last form of the expression:

- $l_c^2 = A_c$
- $A_h = A_c (1 + 2\alpha \Delta T + \alpha^2 \Delta T^2)$

As  $\alpha$  is a very small number,  $\alpha^2 \Delta T^2$  will be very small compared to  $2\alpha \Delta T$  and so we will make an approximation and not include this small term in the final expression. In other words,  $\alpha^2 \Delta T^2$  is approximately zero, so:

- $A_h = A_c (1 + 2\alpha \Delta T)$

We can now compare this expression with the one we obtained earlier in terms of  $\beta$ :

- $A_h = A_c (1 + \beta \Delta T)$

Now we can see that  $\beta \Delta T = 2\alpha \Delta T$  and therefore  $\beta = 2\alpha$ .

Remember, that this is an approximation but a very good one. We do not find tables of  $\beta$  values for substances as they are obtained from  $\alpha$  values using  $\beta = 2\alpha$ .

### Volume expansion of solids

We now need to consider the expansion of a solid in three dimensions, where the length, breadth and height of the substance all increase on heating.

As the block is heated to cause an increase in temperature,  $\Delta T$ , it expands in width, height and breadth such that the volume when heated,  $V_h$ , is larger than the original volume,  $V_c$ .

So:

- $\Delta V = V_h - V_c$

The fractional increase in volume,  $\gamma$ , per unit rise temperature ( $^{\circ}\text{C}$  or  $\text{K}$ ) is given by:

- $\gamma = \Delta V / V_c \Delta T$

- $\Delta V = \gamma V_c \Delta T$

What is the relationship between  $\alpha$  and  $\gamma$  for a given substance?

We will start by recalling what  $\gamma$ , the volume expansion coefficient, means and rewriting the expression:

- $\gamma = \Delta V / V_c \Delta T$

Therefore:

- $\gamma = V_h - V_c / V_c \Delta T$

Making  $V_h$  the subject of the equation:

- $V_h = \gamma V_c \Delta T + V_c$

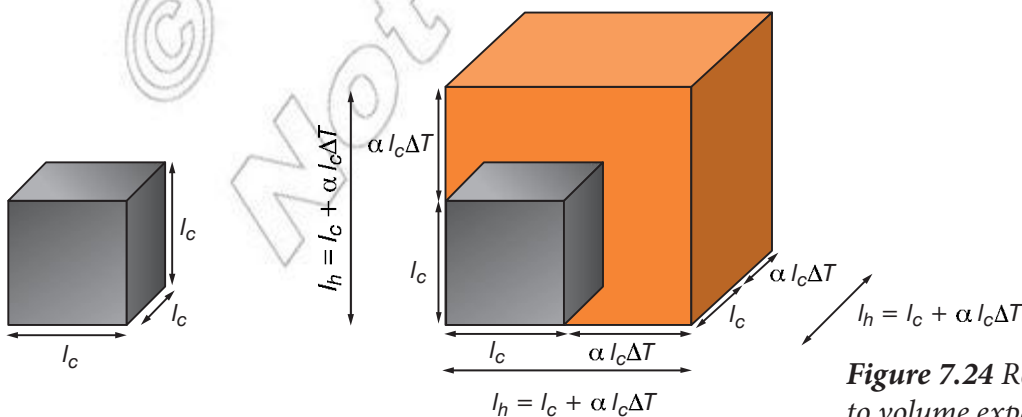
which, after simplifying, gives:

- $V_h = V_c (1 + \gamma \Delta T)$  – this expression will be of use later.

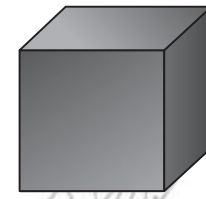
We will now write another expression for  $V_h$ , in terms of  $\alpha$ , the linear expansion coefficient. If a cube, of length  $l_c$ , is heated such that its temperature increases by  $\Delta T$ , each side increases in length,  $\Delta l$ , by  $\alpha l_c \Delta T$  (see the section on linear expansion).

before heating  
volume =  $V_h = l_c^3$

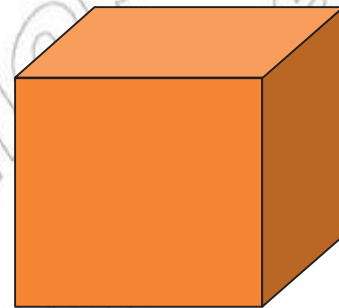
after heating  
volume =  $V_h = l_h^3 = (l_c + \alpha l_c \Delta T)^3$



**Figure 7.24** Relating linear expansion to volume expansion



before heating  
volume =  $V_c$



after heating  
volume =  $V_h$

**Figure 7.23** Three-dimensional expansion of an object

#### Activity 7.4: Volume expansion

Calculate the increase in the volume of an aluminium block with a volume of  $0.008 \text{ m}^3$  at  $25.00 \text{ }^{\circ}\text{C}$ , when it is heated to a temperature of  $90.00 \text{ }^{\circ}\text{C}$ .  $\gamma_{\text{aluminium}} = 6.9 \times 10^{-5} \text{ K}^{-1}$ .

Consequently, the volume of the heated body, is give by  $V_h = l_h^3$   
 $l_h$ , the length of each side of the heated body is related to  $l_c$ :

- $l_h = l_c + \alpha l_c \Delta T$

Consequently,

- $V_h = l_h^3 = (l_c + \alpha l_c \Delta T)^3 = l_c^3(1 + \alpha \Delta T)^3 = l_c^3(1 + 3\alpha \Delta T + 3\alpha^2 \Delta T^2 + \alpha^3 \Delta T^3)$

- $V_h = l_c^3(1 + 3\alpha \Delta T + 3\alpha^2 \Delta T^2 + \alpha^3 \Delta T^3)$

We can further simplify this last form of the expression:

- $l_c^3 = V_c$

- $V_h = V_c(1 + 3\alpha \Delta T + 3\alpha^2 \Delta T^2 + \alpha^3 \Delta T^3)$

As  $\alpha$  is a very small number,  $\alpha^2 \Delta T^2$  and  $\alpha^3 \Delta T^3$  will be very small compared to  $3\alpha \Delta T$ , and so we will make an approximation and not include these small terms in the final expression. In other words,  $\alpha^2 \Delta T^2$  and  $\alpha^3 \Delta T^3$  are approximately zero, so:

- $V_h = V_c(1 + 3\alpha \Delta T)$

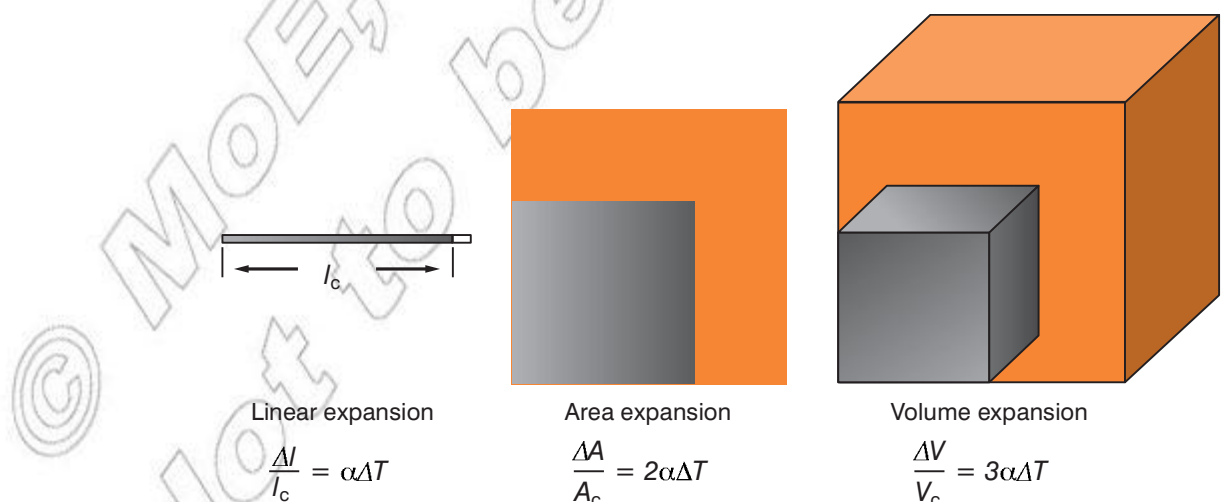
We can now compare this expression with the one we obtained earlier in terms of  $\gamma$ :

- $V_h = V_c(1 + \gamma \Delta T)$

Now we can see that  $\gamma \Delta T = 3\alpha \Delta T$  and therefore  $\gamma = 3\alpha$ .

Remember, that this is also approximation. Once again we do not find tables of  $\gamma$  values for substances as they are obtained from  $\alpha$  values using  $\gamma = 3\alpha$ .

### 1D, 2D and 3D expansion summary

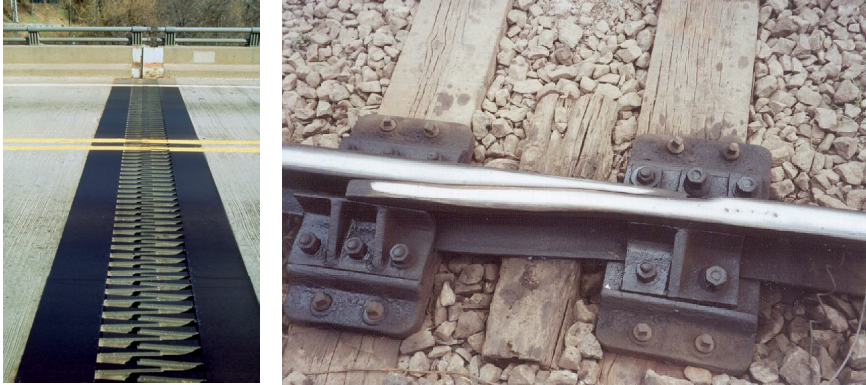


**Figure 7.25** 1D, 2D and 3D expansion summary in terms of  $\alpha$

It often helps to consider  $\alpha$  as one-dimensional (1D),  $\beta$  as 2D (so  $2\alpha$ ) and  $\gamma$  as 3D (so  $3\alpha$ ).

## Problems and applications of thermal expansion

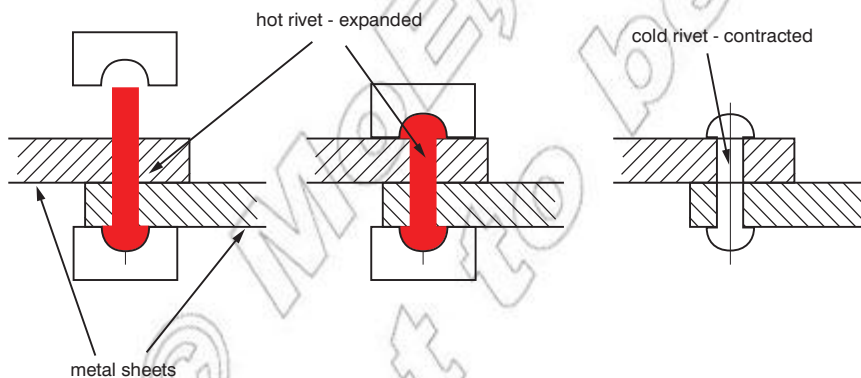
The **thermal expansion** of objects can be a problem. Engineers have to allow for the expansion of concrete and iron on a hot day when building a bridge by constructing an expansion gap to allow for the expanding materials. Railway tracks also have expansion gaps and sections of pipelines in hot countries are linked by flexible pipe, which can accommodate the expanding pipe.



An open expansion joint on a bridge      Railway line

**Figure 7.26** Engineers must consider thermal expansion in a range of contexts.

We can also take advantage of the expansion of materials and put them to good effect. In hot riveting, a hot steel rivet is used to join two metal sheets. Whilst still hot, the rivet is hammered to give a tight joint. As the rivet cools it contracts and makes the joint between the two metal sheets even tighter.



**Figure 7.27** Hot riveting uses the contraction of metals to make tighter connections.

### The bimetallic strip

A **bimetallic strip** is made out of two metals, for example iron and brass bonded together. The coefficient of linear expansion ( $\alpha$ ) of iron ( $1.1 \times 10^{-5} \text{ K}^{-1}$ ) is less than that of brass ( $1.9 \times 10^{-5} \text{ K}^{-1}$ ). When the strip is heated, the brass expands more than the iron and the strip bends.

### Think about this...

How could you tell that the photo of the expansion joint on a bridge was taken on a cold day?

### KEY WORDS

**bimetallic strip** a strip made of two different metals bonded together along their length



**Figure 7.28** The Eiffel Tower in Paris and the Sydney Harbour Bridge were constructed using hot riveting.

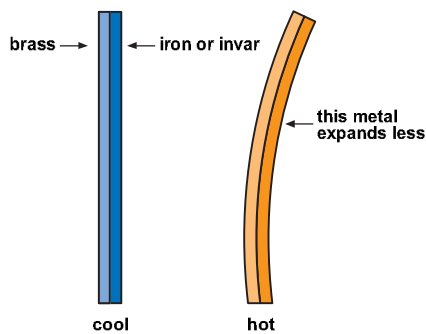


Figure 7.29 The bimetallic strip

**KEY WORDS**

**real expansion** *the actual increase in size of a substance*

**apparent expansion** *the observed increase in size of a substance, which may be affected by the expansion of its container*

The bimetallic strip is used in a thermostat. This is a switch for an electric circuit that turns on and off according to the temperature.

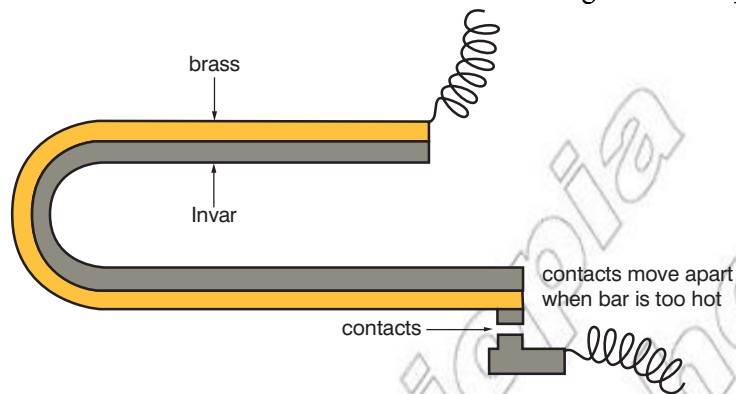


Figure 7.30 A bimetallic strip used as part of a thermostat

When the temperature rises, the brass section of strip expands faster than the iron and the strip bends so as to break the contact. As the temperature drops, the strip contracts, the contacts close and the circuit is restored. We can use this arrangement to switch on and off heating circuits in buildings and cookers, for example – when the desired temperature is reached, heating stops and it will not start again until the temperature has dropped.

**Liquid in glass thermometers**

Mercury in glass and alcohol in glass thermometers use the expansion of a liquid up a narrow glass tube. The higher the temperature, the more the mercury or alcohol expands and the further the liquids move up the capillary tube. As we have already seen, the Celsius scale uses two fixed points. We can calibrate a thermometer for the Celsius scale using the following method.

- a) Place the bulb of an ungraduated thermometer in crushed ice – mark the level of the liquid (alcohol or mercury) when it stops moving. This is the first fixed point.
- b) Place the bulb of the ungraduated thermometer in steam from boiling water. Mark the level of the liquid (alcohol or mercury) when it stops moving. This is the second fixed point.
- c) Divide the distance between the two fixed points into 100 equal divisions – the first fixed point is at 0 °C and the second 100 °C.

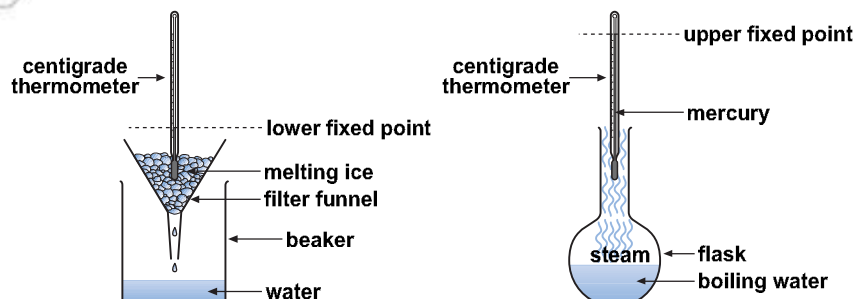


Figure 7.31 Calibrating a thermometer

**DID YOU KNOW?**

The word thermometer comes from the Greek “thermo”, which means warm, and “meter”, to measure.

## Expansion of liquids

Liquids require a container and consequently it only really makes sense to discuss the volume expansion of a liquid. Liquids will tend to expand more than solids for a given increase in temperature but volume expansion coefficients can also apply to liquids.

- $\Delta V = \gamma V_c \Delta T$   
 $\Delta V$  = change in volume.  
 $\Delta T$  = change in temperature.  
 $V_c$  = starting volume.  
 $\gamma$  = volume expansion coefficient.

The expansion of liquids is made more complex, however, by the need for a container. On warming, the container itself will also expand. If you ask most people to predict what they will see when the apparatus below is heated, they will suggest that the water level will rise up the narrow glass tube as it expands.

The water level will indeed rise up the glass tube, but not before it first drops slightly! As the flask is heated, the glass it is made from expands and so the water level drops until the water itself warms up and expands. The expansion of a vessel holding a liquid means the actual or **real expansion** of the liquid is not actually observed. Instead, only an **apparent expansion** of the liquid is observed. Consequently, the extent to which we see the liquid expand (the apparent expansion) is less than its actual expansion (real expansion). It is possible to allow for the expansion of the vessel in calculations:

- $\gamma_{\text{real}} = \gamma_{\text{apparent}} + \gamma_{\text{vessel}}$

so:

- $\gamma_{\text{apparent}} = \gamma_{\text{real}} - \gamma_{\text{vessel}}$

We will use this relationship to calculate the real and apparent expansion of 1000 cm<sup>3</sup> of water when it is warmed from 20 °C to 80 °C.

$$\gamma_{\text{glass}} = 9.90 \times 10^{-6} \text{ K}^{-1} \cdot \gamma_{\text{water}} = 2.07 \times 10^{-4} \text{ K}^{-1} \cdot \Delta T = 80 \text{ }^\circ\text{C} - 20 \text{ }^\circ\text{C} = 60 \text{ }^\circ\text{C}.$$

- real expansion =  $\Delta V_{\text{real}}$

$$\Delta V_{\text{real}} = \gamma_{\text{real}} V_c \Delta T \text{ *State relationship to be used*}$$

$$\Delta V_{\text{real}} = 2.07 \times 10^{-4} \times 0.001 \text{ m}^3 \times 60 \text{ }^\circ\text{C} \text{ *Substitute in known values and complete calculation*}$$

$$\Delta V_{\text{real}} = 1.24 \times 10^{-5} \text{ m}^3 \text{ *Clearly state the answer with unit*}$$

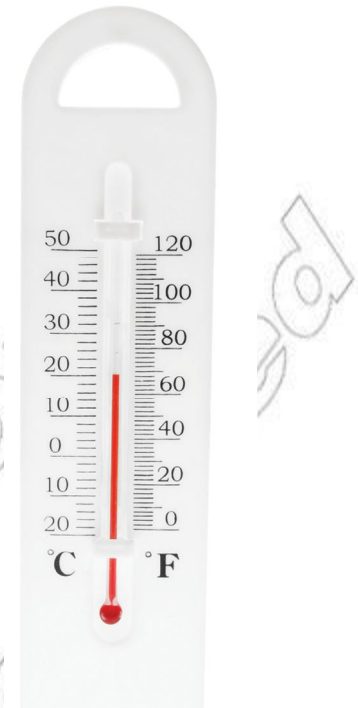
- apparent expansion =  $\Delta V_{\text{apparent}}$

$$\gamma_{\text{apparent}} = \gamma_{\text{real}} - \gamma_{\text{vessel}} \text{ *State relationship to be used*}$$

$$\gamma_{\text{apparent}} = 2.07 \times 10^{-4} \text{ K}^{-1} - 9.90 \times 10^{-6} \text{ K}^{-1} = 1.97 \times 10^{-4} \text{ K}^{-1} \text{ *Substitute in known values and complete calculation*}$$

So:

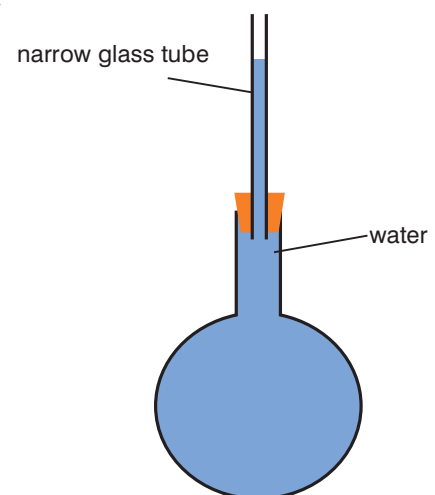
$$\Delta V_{\text{apparent}} = \gamma_{\text{apparent}} V_c \Delta T \text{ *State relationship to be used*}$$



**Figure 7.32** A thermometer is a simple yet very useful piece of equipment.

### Activity 7.5: Expansion of a liquid

Calculate the increase in the volume of 0.0025 m<sup>3</sup> of mercury at 5.00 °C, when it is heated to a temperature of 55.00 °C.  $\gamma_{\text{mercury}} = 1.8 \times 10^{-4} \text{ K}^{-1}$ .



**Figure 7.33** What will happen to the liquid if this object is heated?



$$\Delta V_{\text{apparent}} = 1.97 \times 10^{-4} \text{ K}^{-1} \times 0.001 \text{ m}^3 \times 60 \text{ }^\circ\text{C}$$

*Substitute in known values and complete calculation*

$$\Delta V_{\text{apparent}} = 1.18 \times 10^{-5} \text{ m}^3$$

*Clearly state the answer with unit*

This calculation demonstrates that the real expansion of a liquid is greater than the apparent expansion.

### Expansion of solids, liquids and gases

For a given change in temperature,  $\Delta T$ , liquids will tend to expand significantly more than solids. This difference is clear when we compare values of coefficients of volume expansion for solids and liquids. We can see that  $\gamma_{\text{liquid}} > \gamma_{\text{solid}}$ .

**Table 7.2** Volume expansion coefficient of solids and liquids

Substance (solid)	Volume expansion coefficient ( $\gamma$ ) ( $\times 10^{-5} \text{ K}^{-1}$ )	Substance (liquid)	Volume expansion coefficient ( $\gamma$ ) ( $\times 10^{-5} \text{ K}^{-1}$ )
aluminium	6.9	petrol	95.0
copper	5.1	ethanol	75.0
brass	5.7	water	21.0
iron	3.3	mercury	18.0

You will notice that there are no volume expansion coefficients for gases. This is because the volume of a gas is dictated by a number of factors. The temperature is certainly one of these, but we also have to consider the pressure and the amount (number of moles) of gas present. The relationship between the volume of a gas and its temperature can be shown using the ideal gas equation:

- $pV = nRT$   
 $p$  = pressure of gas in Pa  
 $V$  = volume of gas in  $\text{m}^3$   
 $n$  = number of moles of gas in mol  
 $R$  = universal gas constant (8.314 J/K/mol)  
 $T$  = absolute temperature in K

You will notice that there is no constant in the equation relating to the nature of the gas. The equation applies to all “ideal gases” and is a good approximation for most gases. If the pressure and the amount of gas are constant, we notice that the volume is proportional to the absolute temperature:

- $V \propto T$

So, if the absolute temperature of a given quantity of gas is doubled at constant pressure, the volume doubles!

Gases will consequently tend to expand more for a given temperature rise than liquids, which in turn expand more than solids.

## The unusual behaviour of water

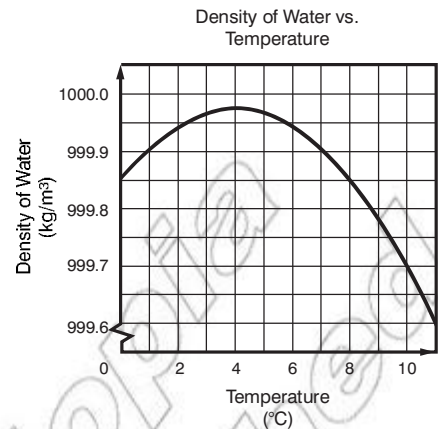
In most cases when a liquid is frozen, the solid formed will have a lower volume than the initial liquid. We can explain this in terms of kinetic theory.

In a solid, the particles are closer together than they are in a liquid. Hence, for a given mass of substance, the solid usually has a lower volume and a higher density than its liquid state. Water though is an exception. The graph in Figure 7.34 shows that water has a maximum density at just under 4 °C.

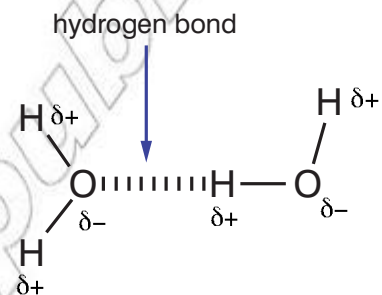
Let's look at this graph in a little more detail. As the water cools below 10 °C, the water behaves as expected at first. It increases in density as its particles lose energy and move closer together. Then, at just below 4 °C, the density starts to decrease. A drop in density can only mean that the water molecules are further apart in water at 2 °C than they are at 8 °C. Why is this?

To understand this unusual observation, we need to know more about the forces acting between water molecules. Water has the chemical formula  $H_2O$ ; it is composed of two hydrogen atoms and one oxygen atom. Liquid water has a very high boiling point for its molecular size because strong intermolecular forces (hydrogen bonds) form between the oxygen atom in one molecule and a hydrogen atom in another. To boil water, these strong hydrogen bonds have to be broken.

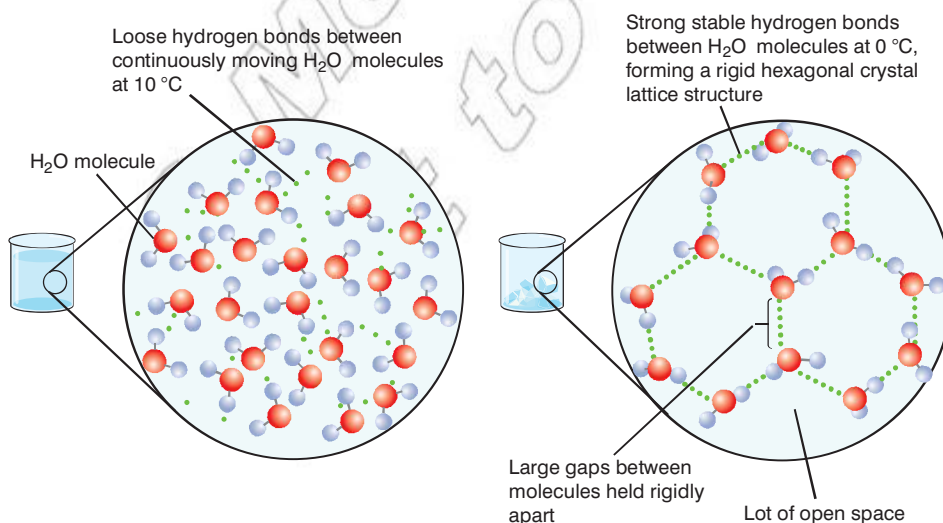
Normally in liquid water, each water molecule forms one hydrogen bond to another water molecule. As the temperature of water drops towards 4 °C though, the molecules are closer together and each molecule begins to form a second hydrogen bond with another water molecule. In order for this second hydrogen bond to form, the molecules now need to be in very exact relative positions and the molecules end up moving further apart to allow this second bond to form. This gives water below 4 °C and ice a more open molecular structure than warmer water.



**Figure 7.34** How the density of water changes with temperature.



**Figure 7.35** A hydrogen bond between water molecules



**Figure 7.36** The molecules are further apart in frozen water than in water at 4 °C.

So, with a more open structure, ice and cold water below 4 °C have a lower density and a higher volume than warmer water. This explains why ice will float on water. The expansion of water on freezing can cause other problems though. When it gets cold, water in pipes can freeze, expand and then break the pipe!

### Summary

In this section you have learnt that:

- The thermal expansion of solids can be explained in terms of the increasing distance between particles that occurs on warming.
- The expression for the linear expansion of solids is  $\Delta l = \alpha l \Delta T$  – we can use this to find by how much the length of a sample expands.
- The expression for the surface area expansion of solids is  $\Delta A = \beta A \Delta T$  – we can use this to find by how much the surface area of a sample expands.
- The expression for the volume expansion of solids is  $\Delta V = \gamma V \Delta T$  – we can use this to find by how much the volume of a sample expands.
- The relationship between the coefficient of linear ( $\alpha$ ), area ( $\beta$ ) and volume ( $\gamma$ ) expansion is as follows:  $\beta = 2\alpha$ ,  $\gamma = 3\alpha$ .
- The applications of thermal expansion include the bimetallic strip in thermostats, hot riveting and thermometers.
- The real expansion of a liquid is less than the apparent expansion as the vessel holding the liquid also expands.
- The abnormal expansion of water can be explained in terms of its more open molecular structure below 4 °C.
- Gases expand more than both solids and liquids for a given rise in temperature.

### Review questions

1. Explain why solids expand on heating.
2. Calculate the increase in length of a 2 m brass rod that is heated from 0 °C to 150 °C.  $\alpha_{\text{brass}} = 1.9 \times 10^{-5} \text{ K}^{-1}$ .
3. Calculate the surface area of an iron drain cover with a surface area of 0.67 m<sup>2</sup> at 10 °C, when it is heated to a temperature of 105 °C.  $\beta_{\text{iron}} = 2.2 \times 10^{-5} \text{ K}^{-1}$ .
4. Show that, for a given material, the surface expansion coefficient ( $\beta$ ) is about twice the linear expansion coefficient ( $\alpha$ ).
5. Calculate the increase in the volume of a 0.1 m<sup>3</sup> sample of water at 10.00 °C, when it is heated to a temperature of 80.00 °C.  $\gamma_{\text{water}} = 2.1 \times 10^{-4} \text{ K}^{-1}$ .

6. Explain what is meant by the apparent thermal expansion of a liquid and compare its magnitude with the real thermal expansion of the same liquid under the same conditions.
7. Explain why water expands on freezing.

### 7.3 Quantity of heat, specific heat capacity and heat capacity

By the end of this section you should be able to:

- Identify different units of heat energy.
- Define the terms specific heat capacity and heat capacity.
- Describe the factors that affect the amount of heat absorbed or liberated by a body.
- Calculate the amount of heat energy absorbed or liberated by a body using  $Q = mc\Delta T$ .
- Calculate the heat capacity of a body.
- Describe the uses of a calorimeter.
- Explain the significance of the high specific heat capacity of water.
- Use the relationship heat lost = heat gained to solve problems involving heat exchange.

#### What are the units of energy?

As discussed in Unit 4, the scientific unit of energy is the joule (J). You may see another unit of energy called the calorie (cal).

One calorie is the quantity of heat energy required to increase the temperature of 1 g of water by 1 °C. The amount of energy in joules required to increase the temperature of 1 g of water by 1 °C is 4.18 J and so:

- **1 cal = 4.2 J**

The calorie is less frequently used now but you will see later that its definition is connected to the work we do later in this section.

#### What is meant by the term specific heat capacity?

If we were heating a substance to raise its temperature, the amount of heat energy required would depend on three things:

1. The **substance** being heated. A given mass of aluminium will require more energy to raise its temperature by 1 K than the same mass of wood.
2. The **mass** of the substance. The greater the mass of the substance, the more heat energy will be required to raise its temperature.

#### DID YOU KNOW?

The British Thermal Unit is still used in some applications today. It is the quantity of energy needed to raise the temperature of 1 lb of water by 1 °F, which is about 1060 J.

### Worked example

Calculate the quantity of heat energy required to heat a 1.00 kg block of iron from 290 K to 320 K. The specific heat capacity of iron is 470 J/kg K.

$Q = mc\Delta T$  *State principle or equation to be used (from definition of specific heat capacity)*

In this case,  $m = 1.00$  kg,  $c = 470$  J/kg K,  $\Delta T = (320 \text{ K} - 290 \text{ K}) = 30$  K

$Q = 1.00 \text{ kg} \times 470 \text{ J/kg K} \times 30 \text{ K}$   
*Substitute in known values and complete calculation*

$Q = 14\,100 \text{ J} = 14.1 \text{ kJ}$  *Clearly state the answer with unit*

So, 14.1 kJ of heat energy would be required to increase the temperature of a 1.00 kg iron block by 30 K. Equally, if the 1.00 kg iron block cooled by 30 K, the iron block would have to lose 14.1 kJ of heat energy to the surroundings.

### Worked example

Calculate the quantity of heat energy lost from a 580 g sample of water if it cools from 333 K to 278 K. The specific heat capacity of water is 4200 J/kg K.

$Q = mc\Delta T$  *State principle or equation to be used (from definition of specific heat capacity)*

In this case,  $m = 0.58$  kg,  $c = 4200$  J/kg K,  $\Delta T = (333 \text{ K} - 278 \text{ K}) = 55$  K

$Q = 0.58 \text{ kg} \times 4200 \text{ J/kg K} \times 55 \text{ K}$   
*Substitute in known values and complete calculation*

$Q = 13\,398 \text{ J} = 13.4 \text{ kJ}$  *Clearly state the answer with unit*

So, as the 580 g sample of water cools from 333 K to 290 K, it would lose 13.4 kJ of heat energy to its surroundings.

3. The **temperature rise** required. For a given mass of a particular substance, a large temperature increase will require a larger amount of heat energy than a small increase in temperature.

Each substance has a **specific heat capacity** ( $c$ ), which is defined as:

- The heat energy required to raise the temperature of 1 kg of a given substance by 1 K.

The units of specific heat capacity are J/kg K and Table 7.3 shows the specific heat capacities of some materials. We can see that metals tend to have lower specific heat capacities than non-metals and that water has a notably high value.

Table 7.3 Some different specific heat capacities

Substance	Specific heat capacity (J/kg K)
iron	470
copper	420
brass	380
aluminium	910
water	4200
rubber	1700
glass	670

From the definition of specific heat capacity, the quantity heat energy required ( $Q$ ) to increase the temperature of a substance is found using the equation below:

- $c = Q / m\Delta T$

This is usually written as:

- $Q = mc\Delta T$

$m$  = mass of substance (kg)

$c$  = specific capacity of substance (J/kg K)

$\Delta T$  = change in temperature (K). Remember, a change in temperature of 1 °C is the same as a change in temperature of 1 K. So, in this case °C or K may be used.

### Activity 7.6: Specific heat calculations

Calculate the specific heat capacity of a 2.0 kg block of a solid that requires 63 700 J to raise its temperature by 35 K.

A solid has a specific heat capacity of 800 J/kg K. How much heat energy would be released a 250 g sample of this solid if its temperature falls from 310 K to 260 K?

## How can we find the specific heat capacity of a substance?

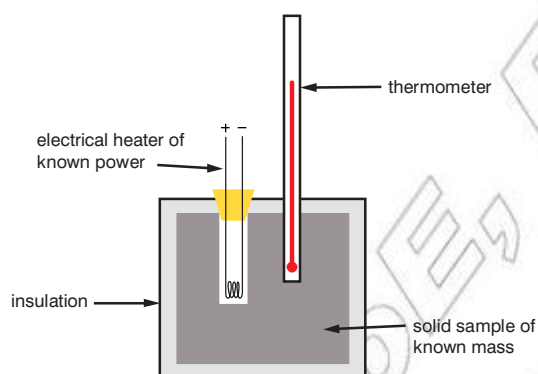
There are several methods we can use to determine the specific heat capacity of a substance, but remember that to calculate this value we will always need to know the **mass** of the substance, the **amount of heat energy** supplied to it as well as its **starting temperature** and **final temperature**. All of these slightly different approaches involve heat exchange. The heat from a hot body is used to warm a colder body. In approaching these heat exchange calculations we use the principle that the heat energy lost from the hot body will equal the heat gained by the cold body.

- **Heat energy lost by hotter body = heat energy gained by colder body**

Sometimes, we try to prevent heat loss to the surroundings using **insulation**. The experimental approach of measuring heat capacities and the heat changes during chemical and physical processes is called **calorimetry**.

### Electrical heating

This method can be used to find the specific heat capacity of a solid or a liquid. The diagram in Figure 7.37 shows the apparatus used to find the specific heat capacity of a solid. In this case, the hot body losing the heat energy is the electrical heater.



**Figure 7.37** Finding the specific heat capacity of a known mass

If we know the power rating of the heater and we know how long the heater is switched on for we can determine the quantity of heat energy supplied to the block. For example, a 100 W electrical heater supplies 100 J of heat energy every second.

We will use the following experimental data to calculate the specific heat capacity of aluminium using this apparatus.

A 100 W electrical heater, running for 5 minutes, warmed a 0.50 kg block. The start temperature of the aluminium block was 20 °C and its final temperature was 85 °C.

Energy supplied = power  $\times$  time *State principle or equation to be used (from the definition of power)*

$E = P \times t$  *Express in the standard symbols*

$E = 100 \text{ W} \times (5 \text{ minutes} \times 60) = 100 \text{ W} \times 300 \text{ s}$  *Substitute in known values and complete calculation*

### Worked example

A 300 g block of brass at 298 K is supplied with 1026 J of energy from an electrical heater. Calculate the final temperature of the brass block after this heating, assuming that there has been no heat loss. The specific heat capacity of brass = 380 J/kg K.

$Q = mc\Delta T$  *State principle or equation to be used (from definition of specific heat capacity)*

$\Delta T = Q / mc$  *Rearrange equation to make  $\Delta T$  the subject*

In this case,  $m = 0.30 \text{ kg}$ ,  $c = 380 \text{ J/kg K}$ ,  $Q = 1026 \text{ J}$ .

$\Delta T = 1026 \text{ J} / (0.30 \text{ kg} \times 380 \text{ J/kg K})$  *Substitute in known values and complete calculation*

- $\Delta T = 9 \text{ K}$  *Clearly state the answer with unit*

So, we have found that  $\Delta T = 9 \text{ K}$ . As the brass block has been heated, the temperature would have increased and so the final temperature = 298 K + 9 K = 307 K or 34 °C. *Ensure the final temperature is calculated, not just  $\Delta T$*

### DID YOU KNOW?

Even on his honeymoon in the Swiss Alps, James Joule did not stop work. He tried to show that when water falls through 778 feet, its temperature rises by 1 °F but all the spray got in the way!

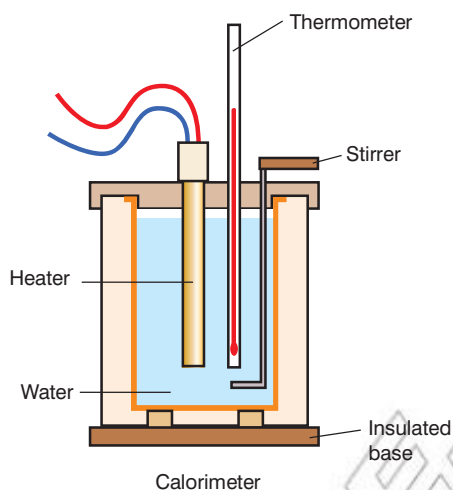
**KEY WORDS**

**calorimetry** *the experimental approach to measuring heat capacities and heat changes during chemical and physical processes*

**final temperature** *the temperature of a substance after heating*

**insulation** *material which does not conduct heat energy and hence can prevent heat loss*

**starting temperature** *the temperature of a substance before heating*



**Figure 7.38** Determining the specific heat capacity of a liquid

$$E = 30\,000\text{ J} \quad \text{Clearly state the answer with unit}$$

Assuming all this energy goes into heating the block

$$Q = 30\,000\text{ J}$$

$$Q = mc\Delta T \quad \text{State principle or equation to be used (from definition of specific heat capacity)}$$

$$c = Q / m\Delta T \quad \text{Rearrange equation to make } c \text{ the subject}$$

$$\text{In this case, } m = 0.50\text{ kg, } \Delta T = (85\text{ }^\circ\text{C} - 20\text{ }^\circ\text{C} = 65\text{ }^\circ\text{C}) = 65\text{ K, } Q = 30\,000\text{ J.}$$

$$c = 30\,000\text{ J} / (0.50\text{ kg} \times 65\text{ K}) \quad \text{Substitute in known values and complete calculation}$$

$$c = 923\text{ J/kg K} \quad \text{Clearly state the answer with unit}$$

We have ignored any heat energy supplied to the thermometer and any heat lost to the surroundings, and assumed that the electrical heater is 100% efficient in this calculation.

Electrical heating can also be used to determine the specific heat capacity of a liquid. An insulated container could be used for the liquid and the data obtained will be the same as for the example above. Alternatively, a calorimeter could be used to hold the liquid. A calorimeter is a polished metal can. In this case, the liquid is continuously stirred and we will take into account the heat energy supplied to the calorimeter as well as that supplied to the liquid. The diagram in Figure 7.38 shows the use of a calorimeter to determine the specific heat capacity of water.

We will use some experimental data from this method to calculate the specific heat capacity of water. The important factor to remember here is that some of the heat energy supplied by the heater will warm the calorimeter and stirrer as well as the water.

The electrical heater has a power rating of 200 W. It caused the water to increase in temperature from 25 °C to 74 °C after running for 5 minutes.

$$\text{Mass of water} = 200\text{ g}$$

$$\text{Mass of aluminium calorimeter and stirrer} = 400\text{ g}$$

$$\text{Specific heat capacity of aluminium} = 910\text{ J/kg K}$$

$$\text{Heat energy supplied by heater (} Q_h \text{)} = \text{heat energy received by water (} Q_w \text{)} + \text{heat energy received by aluminium calorimeter (} Q_c \text{)}$$

The water and the stirrer will be in thermal equilibrium and so the temperature change for both will be the same (i.e.  $\Delta T = 74\text{ }^\circ\text{C} - 25\text{ }^\circ\text{C} = 49\text{ }^\circ\text{C} = 49\text{ K}$ ).

**Heat supplied by heater ( $Q_h$ ):**

$$E = P \times t \quad \text{State principle or equation to be used (from the definition of power)}$$

$$E = 200\text{ W} \times (5\text{ minutes} \times 60) = 200\text{ W} \times 300\text{ s} \quad \text{Substitute in known values and complete calculation}$$

**DID YOU KNOW?**

“calorimeter” comes from the Latin *calor*, which means heat.

$E = 60\,000\text{ J}$  *Clearly state the answer with unit*

$Q_h = 60\,000\text{ J}$

**Heat energy received by calorimeter and stirrer ( $Q_c$ ):**

$Q_c = mc\Delta T$  *State principle or equation to be used (from definition of specific heat capacity)*

$Q_c = 0.40\text{ kg} \times 910\text{ J/kg K} \times 49\text{ K}$  *Substitute in known values and complete calculation*

$Q_c = 17\,836\text{ J}$  *Clearly state the answer with unit*

**Heat energy received by water ( $Q_w$ ):**

$Q_h = Q_w + Q_c$  *Express the relationships between the energies.*

$60\,000\text{ J} = Q_w + 17\,836\text{ J}$  *Substitute in known values*

$Q_w = 60\,000\text{ J} - 17\,836\text{ J}$  *Rearrange to make  $Q_w$  the subject complete calculation*

$Q_w = 42\,164\text{ J}$  *Clearly state the answer with unit*

**Specific heat capacity of water:**

$Q_w = mc\Delta T$  *State principle or equation to be used (from definition of specific heat capacity)*

$c = Q_w / m\Delta T$  *Rearrange equation to make  $c$  the subject*

In this case,  $m = 0.20\text{ kg}$ ,  $\Delta T = 49\text{ }^\circ\text{C}$ ,  $Q_w = 42\,164\text{ J}$ .

$c = 42\,164\text{ J} / (0.20\text{ kg} \times 49\text{ }^\circ\text{C})$  *Substitute in known values and complete calculation*

$c = 4302\text{ J/kg K}$  *Clearly state the answer with unit*

Once again, this is an experimental value – one major source of error will be heat loss to the surroundings, despite the precautions taken.

## Method of mixtures

This method can be adapted to measure the specific heat capacity of a solid or liquid.

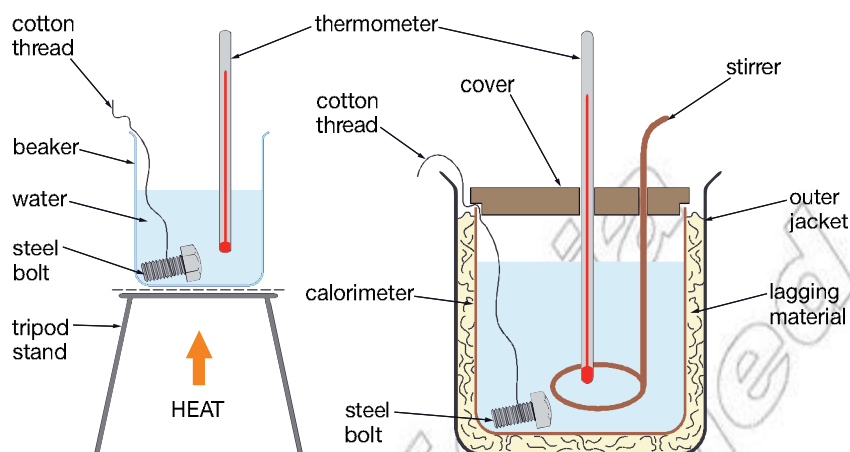
The diagram in Figure 7.39 on the next page shows the method used to determine the specific heat capacity of a solid. The solid, of known mass,  $m_s$ , is heated in a water bath at  $100\text{ }^\circ\text{C}$  for at least 5 minutes. The solid is then quickly transferred to the cold water of known mass,  $m_w$ , in the calorimeter.

We know that the start temperature of the solid object is  $100\text{ }^\circ\text{C}$ . Once in the calorimeter, the hot object (in this case a steel bolt) loses some heat energy to the colder water, and the colder calorimeter and stirrer. We stir the water and record the highest temperature on the thermometer.

### Activity 7.7: Specific heat capacity calculation

A copper calorimeter and stirrer of mass  $350\text{ g}$  contains  $250\text{ g}$  of a liquid. A  $500\text{ W}$  heater running for 2 minutes and 30 seconds heated this combination of liquid and calorimeter from  $20\text{ }^\circ\text{C}$  to  $88\text{ }^\circ\text{C}$ . Calculate the specific heat capacity of this liquid given that the specific heat capacity of copper is  $420\text{ J/kg K}$ .





**Figure 7.39** Determining the specific heat capacity of a bolt using the method of mixtures

In this case, the heat lost by the hot bolt will be equal to the heat gained by the water and the calorimeter/stirrer.

Mass of water = 200 g.

Specific heat capacity of water = 4200 J/kg K.

Mass of copper calorimeter and copper stirrer = 100 g.

Specific heat capacity of copper = 420 J/kg K.

Start temperature of water + calorimeter = 20 °C.

Highest temperature of water after addition of the steel bolt = 25 °C.

Mass of steel bolt = 125 g.

Temperature of steel bolt before cooling = 100 °C.

Heat lost by bolt = heat received by water + heat received by calorimeter/stirrer

$$Q_b = Q_w + Q_c$$

Heat received by water  $Q_w$ :

- $Q_w = mc\Delta T$

$$m = 0,200 \text{ kg}$$

$$c = 4200 \text{ J/kg K}$$

$$\Delta T = 25 \text{ °C} - 20 \text{ °C} = 5 \text{ °C} = 5 \text{ K}$$

- $Q_w = 4200 \text{ J}$

Heat received by calorimeter/stirrer  $Q_c$ :

- $Q_c = mc\Delta T$

$$m = 0.100 \text{ kg}$$

$$c = 420 \text{ J/kg K}$$

$$\Delta T = 25 \text{ °C} - 20 \text{ °C} = 5 \text{ °C} = 5 \text{ K}$$

- $Q_c = 210 \text{ J}$

Heat lost by bolt  $Q_b$ :

- $Q_b = Q_w + Q_c$

- $Q_b = 4200 \text{ J} + 210 \text{ J} = 4410 \text{ J}$

**Specific heat capacity of steel bolt  $c_b$ :**

At the end of the experiment, the bolt, water and the calorimeter and stirrer will be in thermal equilibrium and all be at the same temperature = 25 °C

$\Delta T$  = start temperature of bolt – final temperature of bolt = 100 °C – 25 °C = 75 °C = 75 K.

- $Q_b = m \times c_b \times \Delta T$
- $c_b = Q_b / m\Delta T$
- $c_b = 4410 \text{ J} / (0.125 \text{ kg} \times 75 \text{ K})$
- $c_b = 470 \text{ J/kg K}$

This method can be adapted to find the specific heat capacity of a liquid by adding a hot solid of known specific heat capacity to the liquid sample or even by pouring a hot liquid into a cooler one.

**What is the heat capacity of a body?**

We have seen lots of examples of specific heat capacity. The word *specific* here tells us that this is the heat energy required to increase the temperature of 1 kg of a substance by 1 K. In other words, this is specific to 1 kg of the substance.

The **heat capacity** of a body is defined as the energy required to raise the temperature of the given body by 1 K; the mass of the body is not considered, only the energy required to raise its temperature by 1 K.

- **heat capacity =  $Q / \Delta T$**

Let us look again at the calculation to determine the specific heat capacity of the steel bolt.

The experimental data shows us that the steel bolt lost 4410 J and its temperature fell by 75 K, or, to increase its temperature by 75 K, 4410 J of heat energy would be required.

So, if 4410 J of energy causes a 75 K rise, the heat capacity would be:

- heat capacity =  $Q / \Delta T$
- heat capacity = 4410 J / 75 K
- heat capacity = 58.8 J/K.

Note that the units do not include a mass term.

The specific heat capacity of steel is 470 J/kg K and if the heat capacity of a body is known, the specific heat capacity of the material of which it is made can be found provided the mass of the body is known.

- **Specific heat capacity = heat capacity of body / mass of body**

Let's try this with the steel bolt used in the last specific heat capacity experiment.

So, for the steel bolt of mass 0.125 kg:

**KEY WORDS**

**heat capacity** *the energy required to raise the temperature of a body by 1 K*

**Activity 7.8: Heat capacity of a ball**

A plastic ball experiences a temperature rise of 10 K when 600 J of heat energy are supplied to it. Calculate the heat capacity of the ball. What else would you need to know in order to calculate the specific heat capacity of the ball?

- specific heat capacity = heat capacity of body / mass of body
- specific heat capacity = 58.8 J/K / 0.125 kg
- specific heat capacity = 470 J/kg K

We will now try another example:

A solid block requires 3000 J of heat energy to increase its temperature by 60 K. Calculate the block's heat capacity and use this value to calculate its specific heat capacity if the block has a mass of 50 g.

- heat capacity =  $Q / \Delta T$
- heat capacity = 3000 J / 60 K
- heat capacity = 50 J/K
- specific heat capacity = heat capacity of body / mass of body
- specific heat capacity = 50 J/K / 0.05 kg
- specific heat capacity = 1000 J/kg K

**Why is the high specific heat capacity of water so important?**

If you look back at the table of specific heat capacities of different substances, you will see that water has an especially high value. We should think about this further and see if it is important.

If a substance has a high specific heat capacity, it means that a large amount of heat energy is required to bring about a rise in temperature of 1 kg water by 1K. This is important when we remember that water is widely used in industry and in internal combustion engines for cooling.

If a liquid with a low specific heat capacity was used for cooling purposes, a given mass of this liquid would receive very little heat energy before its temperature increased to its boiling point, at which stage it would no longer act as a coolant.

So, the fact that a given mass of water will receive a large amount of heat energy compared to other liquids before it boils makes it very useful for cooling.

The reverse is also true. A large mass of hot water contains a very large amount of energy. This can then be pumped around the house and as the water cools it transfers this heat energy to rooms inside the house.



**Figure 7.40** Water's high specific heat capacity makes it useful for cooling systems.

**Summary**

In this section you have learnt that:

- The specific heat capacity of a substance is the heat energy required to raise the temperature of 1 kg of a given substance by 1 K.

- The heat capacity of a body is the heat energy required to raise the temperature of the body by 1 K.
- The factors that affect the amount of heat absorbed or liberated by a body are the temperature change, the mass of the body and the material making up the body.
- The amount of heat energy absorbed or liberated by a body can be calculated using  $Q = mc\Delta T$ .
- The high specific heat capacity of water is significant as water is used for cooling.
- A calorimeter is used in specific heat capacity and heat capacity experiments.

### Review questions

1. Define the term “specific heat capacity of water”.
2. A metal bar of mass 100 g is warmed from 20 °C to 80 °C. How much heat is absorbed by the metal bar if the specific heat capacity of this metal is 450 J/kg K.
3. In an experiment to calculate the specific heat capacity of a metal, the following results were obtained:
 

Mass of metal = 300 g.

Start temperature = 20 °C.

End temperature = 75 °C.

Power rating of electrical heater = 100 W.

Time of heating = 150 s.

Use this data to calculate the specific heat capacity of the metal.
4. A hot metal block is placed into 50 g of water in an insulated container. The water increases in temperature from 20 °C to 32 °C. The specific heat capacity of water is 4200 J/kg K. Calculate the quantity of heat energy supplied to the water from the metal block.

## 7.4 Changes of state

By the end of this section you should be able to:

- Define the terms latent heat, latent heat of fusion and latent heat of vaporisation.
- Solve problems involving change of state.



**Figure 7.41** No matter how long you heat it the temperature of boiling water will not go over 100 °C.

### DID YOU KNOW?

The term **phase** is sometimes used instead of **state** – i.e. at room temperature and pressure water is in a liquid phase.

### KEY WORDS

**cooling curve** a graph showing the temperature of a substance against time as it loses heat energy and changes state

**heating curve** a graph showing the temperature of a substance against time as heat energy is applied and it changes state

**melted** when a substance has changed from a solid to a liquid state

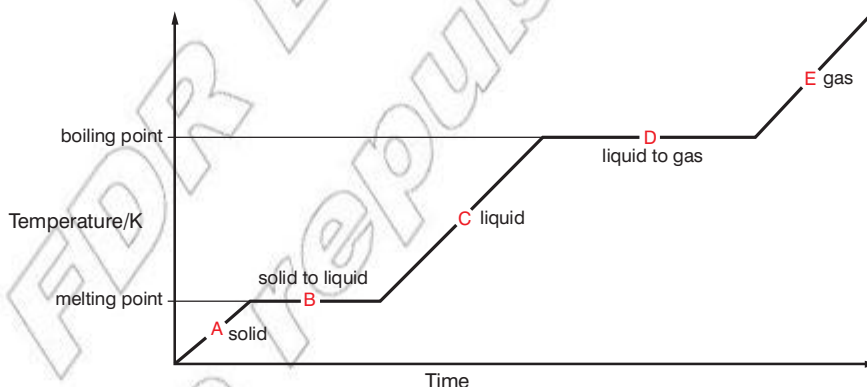
**phase** the distinct form of a substance under different conditions e.g. solid, liquid, gas

## Heating and cooling curves

If we heat a solid, its particles gain energy and begin to vibrate faster and move further apart as its temperature increases. This continues until the solid melts. Even though the solid is continuously heated as it melts, its temperature will not increase until the entire solid has **melted**.

If the heat energy the substance gains is not used to increase the average kinetic energy of its particles (the temperature does not change) what is it being used for? We can see that the same effect occurs when a liquid boils. As the liquid is being heated at its boiling point, the temperature does not increase until all of the liquid has boiled.

The graph in Figure 7.42 shows how the temperature of a solid (A) varies with time as it is heated until melts (B) and finally forms a liquid (C). This is called a **heating curve**. The liquid is heated until it boils (D) until all of the liquid changes state into a gas (E), which continues to increase in temperature as it is heated.

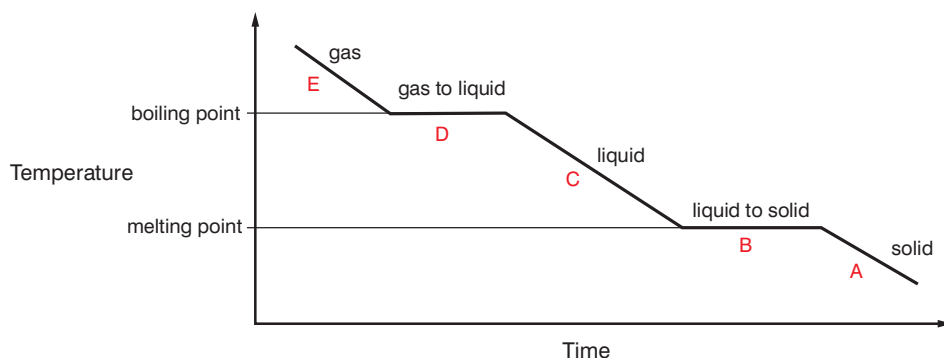


**Figure 7.42** This graph shows how the temperature of water changes as it is continuously heated.

We cannot link the heat energy being absorbed during melting and boiling with an increase in temperature and so the heat energy appears to be hidden or latent.

If latent heat is not being used to increase the kinetic energy of the particles of a substance, what is it being used for? During a change in state, the forces of attraction holding the particles together have to be broken. This process requires energy and so, as a solid melts or a liquid boils, the heat supplied is used to separate the particles rather than to increase their kinetic energy. Consequently, the temperature of the substance does not change during a change in state. This is true for melting, boiling as well as condensing and freezing.

A similar shape is seen when the **cooling curve** of a substance is examined (Figure 7.43). When changes of state occur, the temperature remains constant as only potential energy is being lost as forces of attraction act between the particles again.



**Figure 7.43** A cooling curve for a gas cooling to eventually become a solid.

### Definition of specific latent heat

The specific latent heat ( $L$ ) of a substance is defined as:

- **The quantity of heat energy required to change 1 kg of a substance from one state to another, at constant temperature.**

Specific latent heat has the units of J/kg. Notice again that we use the term 'specific' as this quantity is 'specific' for 1 kg of a substance.

In terms of an equation we have:

- $L = Q / m$

$L$  = specific latent heat in J/kg

$Q$  = energy required in J

$m$  = mass in kg

This is usually written as:

- $Q = mL$

However, there are two changes of state to consider, liquid to gas and solid to liquid. We use two different versions of latent heat, the **latent heat of fusion** (melting) and **latent heat of vaporisation** (boiling).

### Specific latent heat of fusion ( $L_f$ )

This is the quantity of heat energy required to change 1 kg of a substance from a solid to a liquid at constant temperature.

### Specific latent heat of vaporisation ( $L_v$ )

This is the quantity of heat energy required to change 1 kg of a substance from a liquid to a gas at constant temperature.

Table 7.4 shows the values of the specific latent heat of fusion and specific latent heat of vaporisation for some elements and compounds.

### Activity 7.9: A cooling curve

Draw the shape of a cooling curve, starting at 90 °C, for a substance that has a boiling point of 83 °C and a melting point of 40 °C. Continue the cooling curve until the temperature reaches 25 °C.

### KEY WORDS

**state** the distinct form of a substance under different conditions e.g. solid, liquid, gas

**latent heat of fusion** the amount of heat energy required to change the state of a substance from a solid to a liquid at constant temperature

**latent heat of vaporisation** the amount of heat energy required to change the state of a substance from a liquid to a gas at constant temperature

**Worked example**

1. Calculate the heat energy required to melt 1 kg of copper at its melting point.

Heat change absorbed on melting:

$$Q = m \times L_f \text{ *State principle or equation to be used (from definition of specific latent heat)*}$$

$$Q = 1 \text{ kg} \times 209\,000 \text{ J/kg}$$

*Substitute in known values and complete calculation*

$$Q = 209\,000 \text{ J} = 209 \text{ kJ}$$

*Clearly state the answer with unit*

2. Calculate the mass of water that changes state if the water is at its boiling point and 500 kJ of energy is supplied.

$$Q = m \times L_v \text{ *State principle or equation to be used (from definition of specific latent heat)*}$$

$$m = Q / L_v \text{ *Rearrange equation to make m the subject*}$$

$$m = 500\,000 \text{ J} / 2\,500\,000 \text{ J/kg}$$

*Substitute in known values and complete calculation*

$$m = 0.2 \text{ kg}$$

*Clearly state the answer with unit*

3. Calculate the heat energy liberated when 0.025 kg of aluminium freezes at its freezing point.

Heat change given out on freezing:

$$Q = m \times L_f \text{ *State principle or equation to be used (from definition of specific latent heat)*}$$

$$Q = 0.025 \text{ kg} \times 390\,000 \text{ J/kg}$$

*Substitute in known values and complete calculation*

$$Q = 9750 \text{ J} = 9.75 \text{ kJ}$$

*Clearly state the answer with unit*

In this case, this is the energy given out to the surroundings as the aluminium freezes.

*Table 7.4 Some specific latent heats of fusion and vaporisation*

Substance	Specific latent heat of fusion, $L_f$ (J/kg)	Specific latent heat of vaporisation, $L_v$ (J/kg)
aluminium	390 000	10 900 000
copper	209 000	4 730 000
gold	63 700	1 645 000
iron	245 000	6 080 000
water	334 000	2 500 000

Looking carefully at Table 7.4 we can see that the specific latent heat of vaporisation is always much higher than the specific latent heat of fusion. This means it takes a great deal more energy to turn a liquid to a gas than it does to turn a solid into a liquid. This is because when a substance changes from a liquid to a gas the bonds between all the molecules have to be broken apart, whereas the particles in a liquid remain bonded together.

The melting point of aluminium is 660 °C. So, at 660 °C, 1 kg of solid aluminium would require 390 000 J of heat energy to change its state into a liquid. This also means that 390 000 J of heat energy would be given out if 1 kg of liquid aluminium at 660 °C changed state into a solid.

Now we will work through some example calculations, using the specific latent heat data in Table 7.4.

**Activity 7.10: Changes of state**

Calculate the heat energy required to boil 100 g of aluminium at its boiling point.  $L_v$  (aluminium) = 10 900 000 J/kg).

Calculate the heat energy liberated when 2 kg of water turns to a solid at its melting point.  $L_f$  (water) = 334 000 J/kg.

Now that we can use specific heat capacities and specific latent heats, we can calculate the heat energy required when substances are heated, taking into account changes in state.

- **Total energy required = energy required to increase temperature + energy required to change state**
- $Q_{\text{total}} = mc\Delta T + mL$

For example, we will now calculate the heat energy required to increase the temperature of 50 g of water from 25 °C to 125 °C.

Specific heat capacity of water = 4200 J/kg K.

Specific heat capacity of steam = 2080 J/kg K.

Specific latent heat of vaporisation of water = 2 501 000 J/kg.

We will need to calculate the heat energy required for this change in three stages:

1. Heat energy required to heat 50 g of water from 25 °C to 100 °C ( $\Delta T = 75 \text{ °C} = 75 \text{ K}$ ):

- $Q = mc\Delta T$
- $Q = 0.05 \text{ kg} \times 4200 \text{ J/kg K} \times 75 \text{ K}$
- $Q_1 = 15\,750 \text{ J}$

2. Heat energy required to boil 50 g of water at 100 °C:

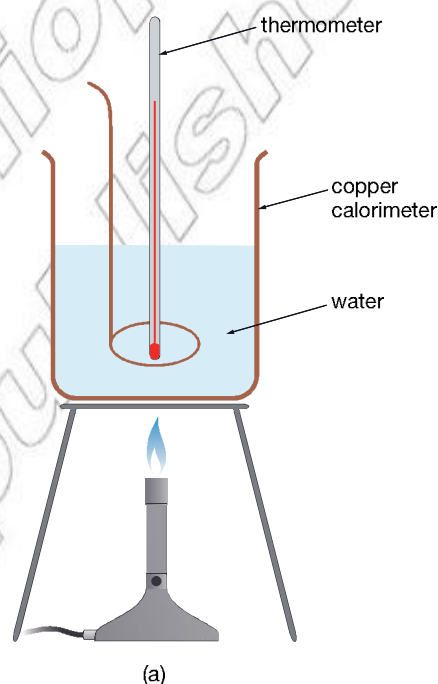
- $Q = mL_v$
- $Q = 0.05 \text{ kg} \times 2\,501\,000 \text{ J/kg}$
- $Q_2 = 125\,050 \text{ J}$

3. Heat energy required to heat 50 g of steam from 100 °C to 125 °C ( $\Delta T = 25 \text{ °C} = 25 \text{ K}$ ):

- $Q = mc\Delta T$
- $Q = 0.05 \text{ kg} \times 2080 \text{ J/kg K} \times 25 \text{ K}$
- $Q_3 = 2600 \text{ J}$ .

So, the total amount of heat energy required for this process:

- $Q = Q_1 + Q_2 + Q_3$
- $Q = 15\,750 \text{ J} + 125\,050 \text{ J} + 2600 \text{ J}$
- $Q = 143\,400 \text{ J} = 143.4 \text{ kJ}$



(a)

### Experiment to determine the specific latent heat of fusion of ice

The apparatus in Figure 7.44 can be used to determine the specific latent heat of fusion,  $L_f$ , of ice.

The copper calorimeter and stirrer is weighed before being half filled with water. The mass of the water present in the calorimeter is then determined before the water is heated to at least 10 °C above room temperature. Small quantities of ice are then added to the water, while stirring, until the temperature is below room temperature and all the ice has melted. The mass of the calorimeter, stirrer and water is then determined to find out the mass of ice added.

We will use the experimental data obtained using this method to determine the specific latent heat of fusion of ice.

Mass of calorimeter = 0.15 kg.

Mass of water = 2.00 kg.

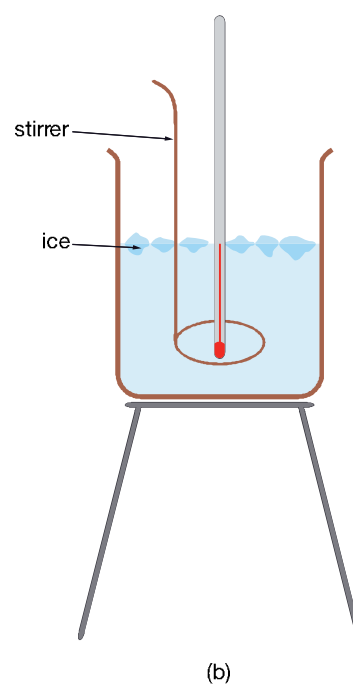
Mass of ice added = 0.60 kg.

Start temperature of ice = -10 °C.

Start temperature of water = 49 °C.

Final temperature of water = 20 °C.

Specific heat capacity of water = 4200 J/kg K.



(b)

**Figure 7.44** A simple experiment to determine the specific latent heat of fusion of ice.



Specific heat capacity of ice = 2100 J/kg K.

Specific heat capacity of copper = 420 J/kg K.

We will use the principle here that the heat energy lost from the water and the calorimeter will go to warming and melting the ice and then warming the cold water produced when the ice melts.

Heat energy absorbed by ice = Heat energy liberated from  
and cold water calorimeter/stirrer and water and water

### 1. Heat energy lost by calorimeter/stirrer and water:

- $\Delta T = 49\text{ }^{\circ}\text{C} - 20\text{ }^{\circ}\text{C} = 29\text{ }^{\circ}\text{C} = 29\text{ K}$

Heat energy lost by calorimeter:

- $Q_{\text{lost calorimeter}} = m_{\text{calorimeter}} c_{\text{calorimeter}} \Delta T$

- $Q_{\text{lost calorimeter}} = 0.15\text{ kg} \times 420\text{ J/kg K} \times 29\text{ K} = 1827\text{ J}$

Heat energy lost by water:

- $Q_{\text{lost water}} = m_{\text{water}} c_{\text{water}} \Delta T$

- $Q_{\text{lost water}} = 2.00\text{ kg} \times 4200\text{ J/kg K} \times 29\text{ K} = 243\text{ }600\text{ J}$

Total heat energy lost by calorimeter/stirrer and water = 243 600 + 1827 = 245 427 J.

### 2. Heat energy absorbed by ice and water in warming from $-10\text{ }^{\circ}\text{C}$ to $20\text{ }^{\circ}\text{C}$ :

Heat energy require to warm ice from  $-10\text{ }^{\circ}\text{C}$  to  $0\text{ }^{\circ}\text{C}$  ( $\Delta T = 0\text{ }^{\circ}\text{C} - (-10\text{ }^{\circ}\text{C}) = 10\text{ }^{\circ}\text{C} = 10\text{ K}$ ).

- $Q_{\text{ice } (-10-0)} = m_{\text{ice}} c_{\text{ice}} \Delta T$

- $Q_{\text{ice } (-10-0)} = 0.60\text{ kg} \times 2100\text{ J/kg K} \times 10\text{ K} = 12\text{ }600\text{ J}$

Heat energy required to melt 0.60 kg of ice:

- $Q_{\text{melt ice}} = mL_f$

- $Q_{\text{melt ice}} = 0.60\text{ kg} \times L_f$

Heat energy require to warm cold water from  $0\text{ }^{\circ}\text{C}$  to  $20\text{ }^{\circ}\text{C}$  ( $\Delta T = 20\text{ }^{\circ}\text{C} - 0\text{ }^{\circ}\text{C} = 20\text{ }^{\circ}\text{C} = 20\text{ K}$ ).

- $Q_{\text{water } (0-20)} = m_{\text{ice}} c_{\text{water}} \Delta T$

- $Q_{\text{water } (0-20)} = 0.60\text{ kg} \times 4200\text{ J/kg K} \times 20\text{ K} = 50\text{ }400\text{ J}$

Heat energy absorbed by ice = Heat energy liberated from  
and cold water calorimeter/stirrer and water

$$12\text{ }600\text{ J} + 0.6L_f + 50\text{ }400\text{ J} = 245\text{ }427\text{ J}$$

- $0.6L_f = 182\text{ }427\text{ J}$

- $L_f = 182\text{ }427\text{ J} / 0.6$

- $L_f = 304\text{ }045\text{ J/kg} = 304\text{ kJ/kg}$

## Summary

In this section you have learnt that:

- The terms specific latent heat of fusion and specific latent heat of vaporisation relate to the energy required to melt and vaporise 1 kg of a substance at constant temperature.
- It is possible to calculate the energy ( $Q$ ) required or liberated on a change of state for a given mass,  $m$ , of a substance using the equation  $Q = mL_f$  or  $Q = mL_v$ .

## Review questions

1. Calculate the heat energy required to melt 10 g of copper at its melting point.  
( $L_f$  for copper = 209 000 J/kg).
2. Calculate the heat energy required to melt 1.2 kg of gold at its melting point.  
( $L_f$  for gold = 63 700 J/kg).
3. Calculate the heat energy liberated when 75 g of iron freezes at its freezing point.  
( $L_f$  for iron = 245 000 J/kg).
4. Define the term specific latent heat of fusion of magnesium.
5. Calculate the heat energy required to increase the temperature of 0.1 kg of water from 10 °C to 150 °C.  
Specific heat capacity of water = 4200 J/kg K.  
Specific heat capacity of steam = 2080 J/kg K.  
Specific latent heat of vaporisation of water = 2 500 000 J/kg.

## End of unit questions

1. Write a paragraph explaining the difference between the heat energy in a substance and the substances' temperature.
2. Explain, with reference to the appropriate laws of thermodynamics and particle movement, what happens when a cold object is in thermal contact with hot object.
3. Calculate the increase in length of an iron pipeline that is 30.00 m long at 20 °C when it is warmed to 45 °C.  $\alpha_{\text{iron}} = 1.1 \times 10^{-5} \text{ K}^{-1}$ .
4. Calculate the increase in volume of ethanol that has a volume of  $2.5 \times 10^{-4} \text{ m}^3$  at 25 °C when it is warmed to 45 °C. Explain why the apparent expansion will be less than this calculated real expansion.  $\gamma_{\text{ethanol}} = 75 \times 10^{-5} \text{ K}^{-1}$ .
5. In an experiment to calculate the specific heat capacity of a metal, the following data were obtained. Use the data to calculate the specific heat capacity of the metal.

Mass of metal = 200 g.  
 Start temperature = 20 °C.  
 End temperature = 105 °C.  
 Heat energy supplied by electrical heating = 2000 J.

6. A metal block increases in temperature from 15 °C to 60 °C when supplied with 13 500 J of heat energy.
  - a) Calculate the heat capacity of the metal.
  - b) Calculate the specific heat capacity of the metal, if this sample has a mass of 0.75 kg.
7. 20 g of water at 42 °C was placed in a well-insulated copper calorimeter with a mass of 27 g at a temperature of 20 °C. Use the specific heat capacities of water (4200 J/kg K) and copper (420 J/kg K) to determine the final temperature of the water.
8. Calculate the heat energy required to increase the temperature of 10.0 kg of water from 25 °C to 115 °C.  
 Specific heat capacity of water = 4200 J/kg K.  
 Specific heat capacity of steam = 2080 J/kg K.  
 Specific latent heat of vaporisation of water = 2 500 000 J/kg.
9. Sketch a cooling curve for bromine as bromine vapour is cooled from 100 °C to -20 °C. Bromine has a melting point = -7 °C and a boiling point of 59 °C. Mark clearly on your graph the melting and boiling point.
10. In an experiment to determine the latent heat of fusion of ice, 0.5 kg of ice at -5 °C was placed into 1.5 kg of water in a copper calorimeter of mass (including stirrer) of 0.2 kg with both water and calorimeter at 61 °C. The final temperature, when all the ice had melted, was 25.0 °C. Use the data to calculate the latent heat of fusion of ice.

Mass of calorimeter = 0.20 kg.  
 Mass of water = 1.50 kg.  
 Mass of ice added = 0.50 kg.  
 Start temperature of ice = -5.0 °C.  
 Start temperature of water = 61 °C.  
 Final temperature of water = 25.0 °C.  
 Specific heat capacity of water = 4200 J/kg K.  
 Specific heat capacity of ice = 2100 J/kg K.  
 Specific heat capacity of copper = 420 J/kg K.

Contents	
Section	Learning competencies
8.1 Wave propagation (page 207)	<ul style="list-style-type: none"> <li>Define the terms wave and wave pulse.</li> <li>Describe longitudinal and transverse waves.</li> <li>Define the terms compression and rarefaction.</li> </ul>
8.2 Mechanical waves (page 214)	<ul style="list-style-type: none"> <li>Define and identify the following features of a wave: crest, trough, wavelength, frequency, amplitude and time period.</li> <li>Distinguish between mechanical waves and electromagnetic waves.</li> <li>Identify transverse and longitudinal waves in a mechanical media.</li> </ul>
8.3 Properties of waves (page 221)	<ul style="list-style-type: none"> <li>State the wave equation and use it to solve problems.</li> <li>Describe the characteristic properties of waves, including reflection, refraction, diffraction and interference.</li> <li>Define the terms diffraction and interference.</li> </ul>
8.4 Sound waves (page 228)	<ul style="list-style-type: none"> <li>Identify sound waves as longitudinal mechanical waves and describe how they are produced and how they propagate.</li> <li>Compare the speed of sound in different materials and determine the speed of sound in air at a given temperature.</li> <li>Define the intensity of a sound wave and solve problems using the intensity formula.</li> <li>Explain the meaning of the terms echo, reverberation, pitch, loudness and quality.</li> <li>Explain the reflection and refraction of sound and describe some applications.</li> </ul>

Water waves are a common sight, either on the sea, in rivers or even in the bath. But have you ever really thought about what the term wave means? Maybe words like ripples, vibrations and energy spring to mind.

Waves enable us to see and to hear, and can even be used to monitor the health of unborn babies. Waves have a dangerous side too. The devastating tsunami on 26 December 2004 demonstrated some of the power of waves.

This unit looks at the different types of waves, their characteristics and behaviour and some of their uses.

### 8.1 Wave propagation

By the end of this section you should be able to:

- Define the terms wave and wave pulse.
- Describe longitudinal and transverse waves.
- Define the terms compression and rarefaction.



**Figure 8.1** Waves are a common sight on water.

## What are waves?

**Waves** can be thought of as a series of **vibrations** that travel through a **medium** (a medium is another way of describing the material through which the wave is travelling).

All waves transfer **energy** from one place to another. Light waves travelling out from a light bulb transfer energy from the bulb to your eye. Sound waves transfer energy from a speaker to your ear.

Although waves transfer energy from one place to another there is no transfer of **matter**. The material the wave is travelling through does not move along with the wave. In other words, when waves travel through water the water does not travel along with the wave.

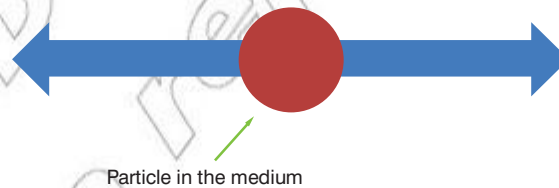
This can be seen by observing a duck (or any object that floats) sitting on the water. As the wave moves past the duck it just bobs up and down. It does not travel along with the wave.

Unless it is a gas, the particles inside any medium are pretty much stationary. They move around a little and are always vibrating a little but essentially they remain in their **equilibrium positions**. When a wave passes through the material the particles in the medium simply **vibrate** from side to side.

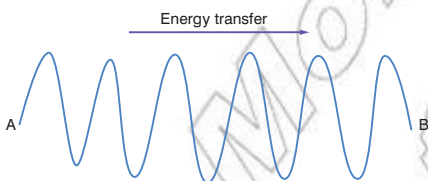
This vibration could be up and down, left to right or any variation, but the particles always move back and forth past their equilibrium position.



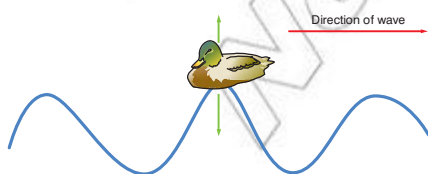
**Figure 8.2** Rays of light travel out as waves from a light bulb.



**Figure 8.5** The particles vibrate back and forth past their equilibrium position.

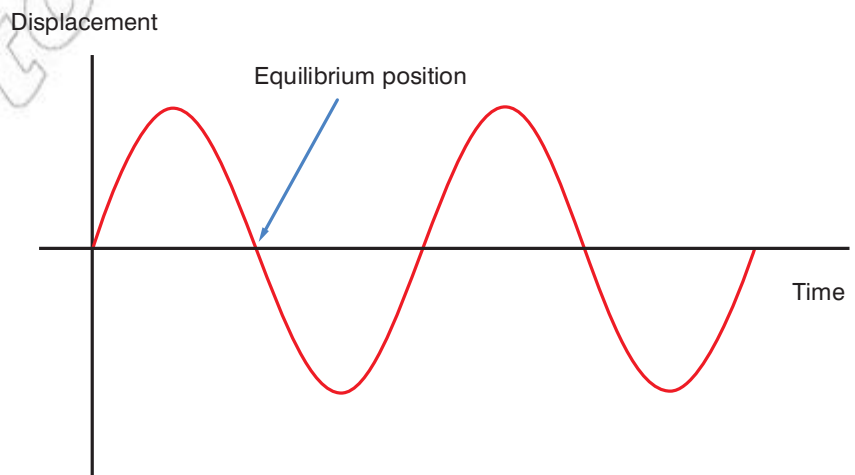


**Figure 8.3** Waves transfer energy from A to B.



**Figure 8.4** A duck floating on the water just moves up and down as the waves go past.

If you plot a graph of the particle's **displacement** from its equilibrium position against time you would get a graph similar to Figure 8.6.



**Figure 8.6** Particle's displacement against time  
It's starting to look like a wave!

## Wave pulses and continuous waves

Poke a stick into some water and you can see water waves (ripples) travelling away from the stick. The stick acts as a **source** for the waves.

If you just poke the stick once into the water a single ripple travels outwards. This is referred to as a **wave pulse**. You can see the same thing with some rubber tubing.

Here you can see that there are no repeated vibrations, just one short pulse.

If instead of just poking the stick into the water once you were to move it in and out you would create a series of ripples. New ripples would be created every time the stick went into and out of the water. This is referred to as a **continuous wave**.

As long as the source of the wave continues to vibrate a continuous wave will travel out from it.

### Activity 8.1: Waves on stretched rubber tubing

- Tie one end of a long piece of rubber tubing to a fixed point in the room.
- Hold the other end, so that the tubing is taut (stretched tightly).
- Move your hand up and down briefly (Figure 8.9). Watch the wave pulse travel along the tubing. Does it reflect at the fixed end?
- Repeat, moving your hand from side to side.
- Try moving your hand up and down at a steady rate; try different frequencies. What do you observe?

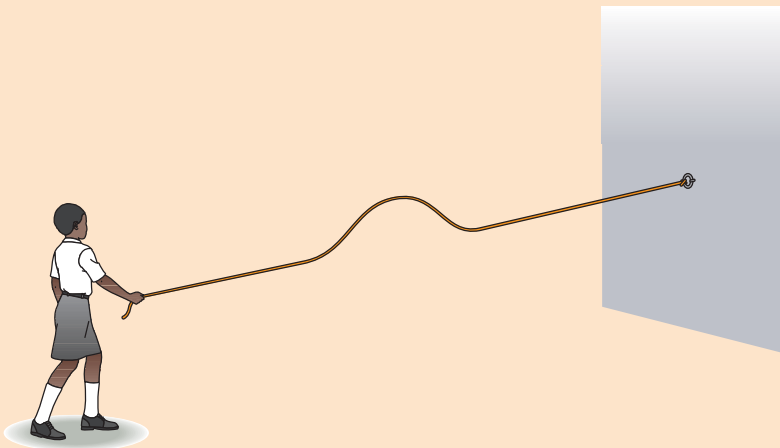


Figure 8.9 Sending a wave pulse along a taut rubber tube

## Longitudinal and transverse waves

There are two main types of wave. These types are classified by the direction of vibrations in relation to the direction of

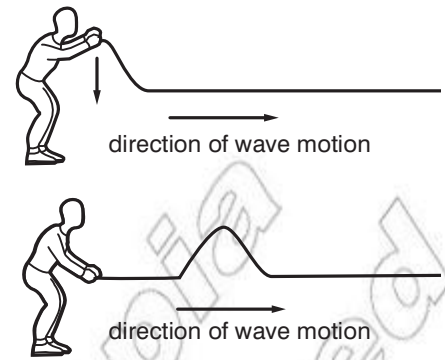


Figure 8.7 A simple wave pulse

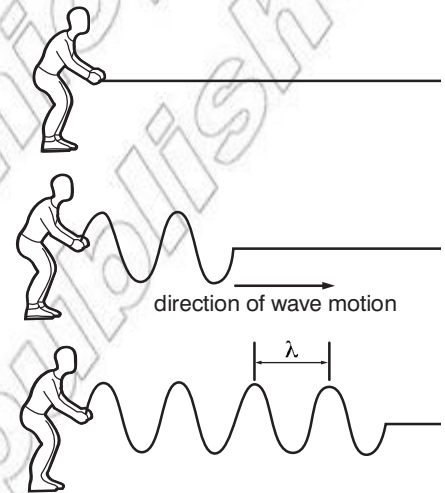


Figure 8.8 A simple continuous wave

### KEY WORDS

**equilibrium position** the central point about which vibrations occur

**matter** a physical substance

**medium** material or substance

**vibrate** to move up and down, or side to side, about a central point

**vibrations** oscillations about a central equilibrium point

**waves** a series of vibrations that travel through a medium

**continuous wave** a wave with repeated vibrations

**source** the cause of the wave

**wave pulse** a wave with no repeated vibrations

**KEY WORDS**

**wave movement** *the direction in which the wave is travelling*

**crests** *the maximum points of a transverse wave*

**transverse waves** *where the vibrations are perpendicular to the direction of wave motion*

**troughs** *the minimum points of a transverse wave*

**wave movement.** Remember, in both cases the material only vibrates from side to side; it does not travel along the wave.

**Transverse**

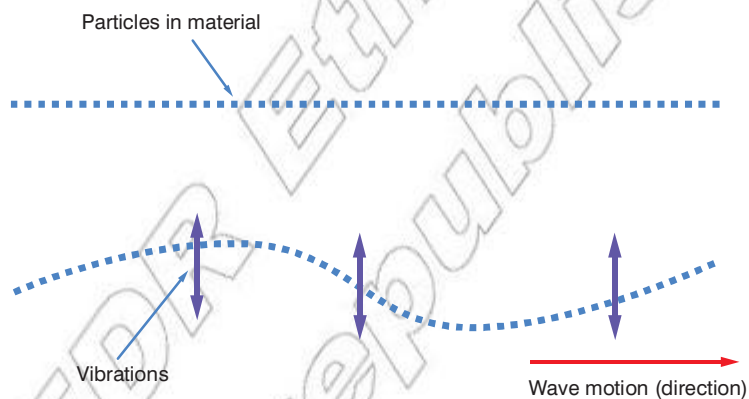
These are the waves most people think of. They go up and down (or left to right) in a sinusoidal motion.

In a **transverse** wave the vibrations are at *right angles* to the direction of wave movement (or energy transfer). This might be up and down or side to side.

A transverse wave is defined as a wave where the:

- **Vibrations are perpendicular (at right angles) to the direction of wave motion.**

This can be seen in Figure 8.10.



**Figure 8.10** *Vibrations in a transverse wave*

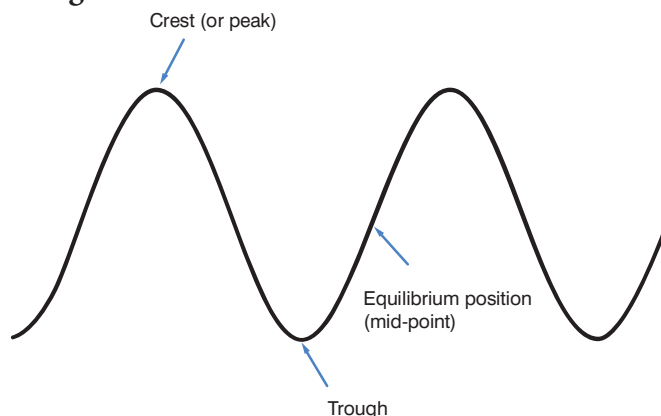
Examples of transverse waves include:

- all electromagnetic waves – more on these in Section 8.2  
light  
microwaves  
radio waves  
X-rays  
etc.
- S-waves in earthquakes
- waves on strings
- waves on the surface of deep water.

**Think about this...**

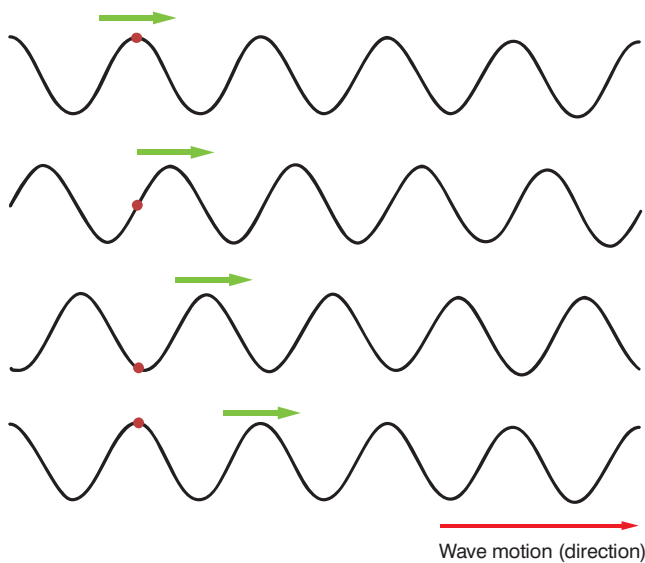
It is easy to remember that transverse waves are the sinusoidal type. If you look carefully at the word **transverse** it has a transverse wave in the middle!

All transverse waves comprise a series of **crests** (or peaks) and **troughs**.



**Figure 8.11** *Crests and troughs*

Like ripples on a pond, the crests travel outwards in the same direction as the wave motion.



**Figure 8.12** Crests travel along with the transverse wave.

It is important to remember that the particles just move up and down past their equilibrium position. This can be seen by the red particle; it just moves up and down as the wave travels from left to right.

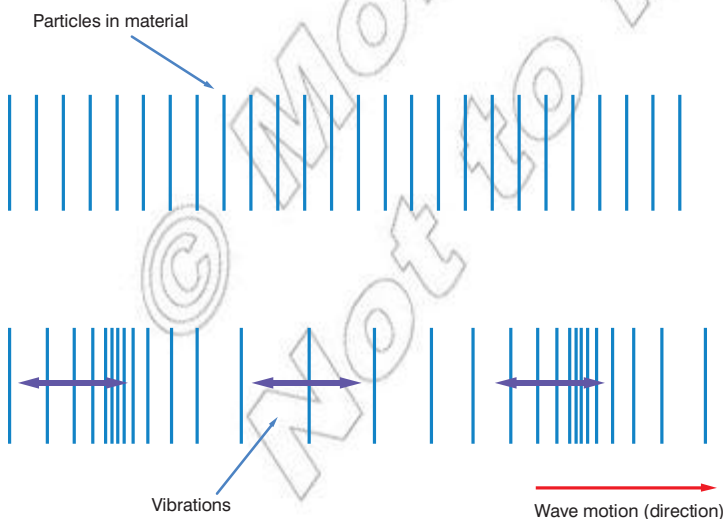
### Longitudinal

In a **longitudinal wave** the vibrations are in the *same direction* as the direction of wave movement (or energy transfer). This means the vibrations are forwards and backwards along the wave.

A longitudinal wave is defined as a wave where the:

- **Vibrations are parallel to (in the same direction of) the direction of wave motion.**

This can be seen in Figure 8.13.



As you can see, these are much more difficult to draw! You tend to see the particles replaced with vertical lines so the wave motion is easier to make out.

### Activity 8.2: The human transverse wave

You need about ten people for this activity.

Form a line standing shoulder to shoulder and link arms tightly at the elbow.

The person at the end of the line acts as the wave source and moves forwards and backwards (only a few steps are needed).

You should be able to see the vibration travel down the line of people.

This is a transverse wave as the vibrations are at right angle to the direction of wave motion.

### KEY WORDS

**longitudinal waves** *waves where the vibrations are parallel to the direction of wave motion*

**Figure 8.13** Vibrations in a longitudinal wave



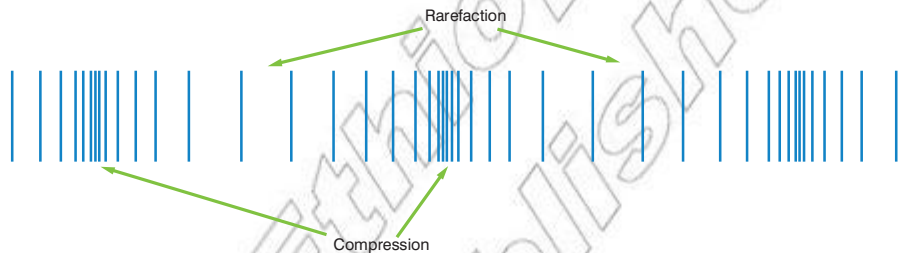
**Think about this...**

Sound waves are often drawn to look like transverse waves. This is because plotting a graph of displacement against time produces exactly the same shape no matter which type of wave it is. This makes comparing them and describing their features much easier. However, they are most definitely longitudinal waves!

Examples of longitudinal waves include:

- sound waves
- pressure waves
- waves forwards and backwards through a spring
- P-waves in earthquakes.

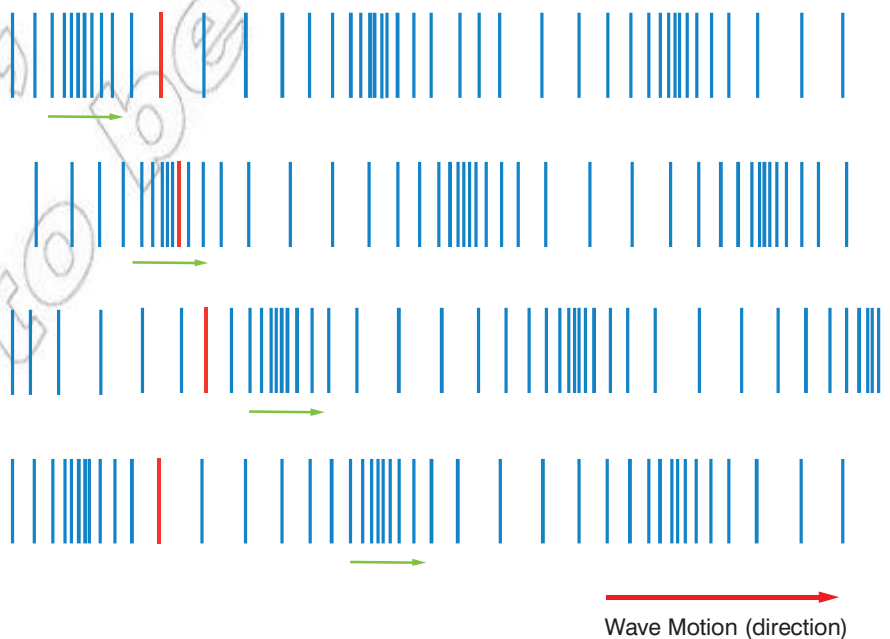
When longitudinal waves travel through a material the particles bunch up then move further apart, then bunch up again. You can see this in Figure 8.14.



**Figure 8.14** Compressions and rarefactions in a longitudinal wave

Regions where the particles are pushed together are called **compressions**. Regions where the particles are more spread out are called **rarefactions**. Compressions can be thought of as the longitudinal version of a crest and a rarefaction is the equivalent of a trough.

If the longitudinal wave is travelling through a gas then a compression can be thought of an area of **higher pressure** and a rarefaction an area of **lower pressure**. Compressions appear to travel through the material as the wave travels through it.



**Figure 8.15** Compressions travel along a longitudinal wave.

It is important to remember that the particles just move forwards and backwards (look at the red line in the diagram).

**KEY WORDS**

**compressions** regions of a wave where the particles are pushed together

**higher pressure** comparatively greater pressure

**lower pressure** comparatively smaller pressure

**rarefactions** regions of a wave where the particles are spread out

**DID YOU KNOW?**

In an explosion a shock wave (a compression) travels outward from the centre of the blast. It is this area of higher pressure that causes damage.

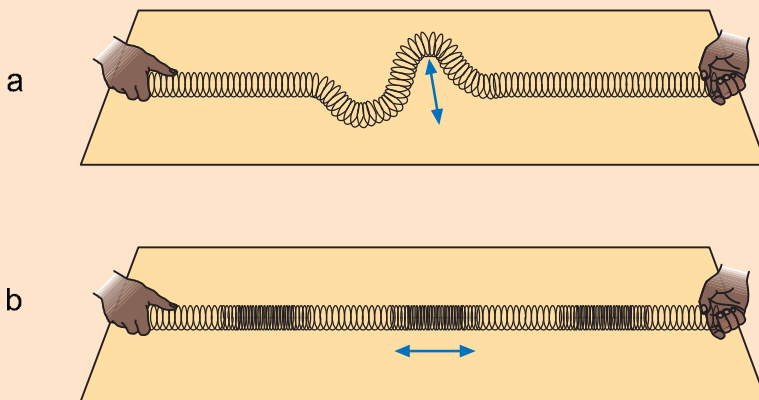
Both transverse and longitudinal waves can also be seen using a long spring.

### Activity 8.4: Waves on a spring

Use a slinky spring. Lay it carefully on a long bench or table. Ask your partner to hold one end firmly.

- As in the previous experiment, move your hand from side to side to send a wave pulse along the spring (Figure 18.6(a)). Send a continuous series of waves along the spring.
- There is a second way in which you can send a wave along a stretched spring. Push the end backwards and forwards, along the length of the spring (Figure 8.16(b)). Watch as the segments of the spring move back and forth.

Can you observe both types of wave reflecting at the fixed end of the spring?



**Figure 8.16** Two types of wave on a stretched spring: (a) transverse, and (b) longitudinal

### Activity 8.3: The human longitudinal wave

Just like before you need about ten people for this activity. Again form a line standing shoulder to shoulder and link arms tightly at the elbow.

This time the person at the end of the line (still acting as the wave source) moves from side to side.

You should be able to see the vibration travel down the line of people and notice areas of compression and rarefaction. This time it is a longitudinal wave as the vibrations are in the same direction as the wave motion.

## Summary

In this section you have learnt that:

- A wave transfers energy from one place to another as a series of vibrations.
- A wave pulse is a wave with no repeated vibrations.
- The particles in the medium vibrate from side to side; they do not travel through the medium with the wave.
- There are two types of wave, longitudinal and transverse.
- In a transverse wave the vibrations are perpendicular to the direction of wave motion.
- A transverse wave comprises a series of crests and troughs.
- In a longitudinal wave the vibrations are parallel to the direction of wave motion.
- A longitudinal wave comprises a series of compressions and rarefactions.
- In a compression the particles are closer together and in a rarefaction they are more spread out.

## Review questions

1. Explain the difference between a continuous wave and a wave pulse.
2. Describe what happens to particles when a wave passes through a medium.
3. Explain what is meant by a transverse wave and give three examples.
4. Explain what is meant by a longitudinal wave and give three examples.

## 8.2 Mechanical waves

By the end of this section you should be able to:

- Define and identify the flowing features of a wave: crest, trough, wavelength, frequency, amplitude and time period.
- Distinguish between mechanical waves and electromagnetic waves.
- Identify transverse and longitudinal waves in a mechanical media.

## Waves characteristics

No matter what the type of wave all waves share some characteristics. These are terms you've probably heard before. However, each has a very specific meaning:

### Wave speed ( $v$ )

Wave speed is defined as:

- **The distance the wave travels in one second.**

This is the same as the distance one peak or one compression travels in one second. It's given the symbol  $v$  (or  $c$  for electromagnetic waves) and like all speeds it is measured in metres per second (m/s).

### Amplitude ( $a$ )

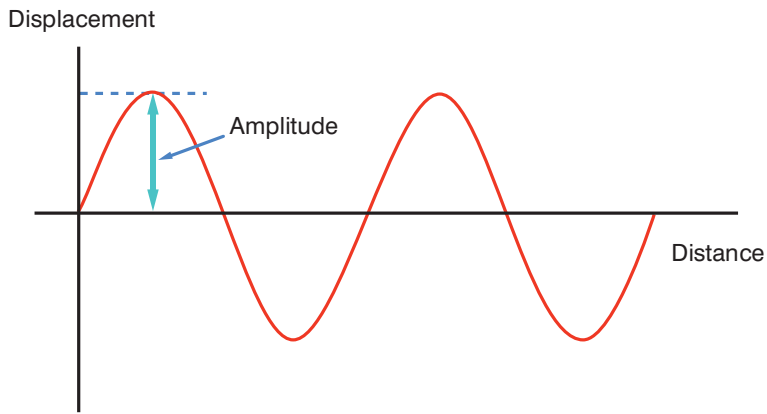
Amplitude is defined as:

- **The maximum displacement from the equilibrium position.**

In simple terms it's the maximum height of the wave. If you plot a graph of particle displacement against distance along the wave the amplitude can be easily determined.

### DID YOU KNOW?

Nothing can travel faster than the speed of light through a vacuum. This is the ultimate speed limit. It is equal to 300 000 000 m/s (or  $3 \times 10^8$  m/s). That's fast enough to go around the world just under 8 times per second.



**Figure 8.17** Amplitude

Notice that it is from the equilibrium position (mid-point), it is not the distance from top to bottom.

Amplitude is given the symbol  $a$  (or occasionally  $x_0$ ). As amplitude is a displacement it is measured in metres (m).

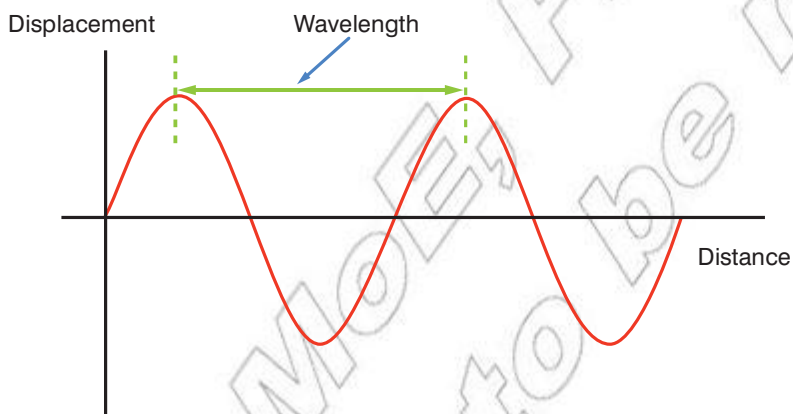
### Wavelength ( $\lambda$ )

Wavelength is defined as:

- **The minimum distance between identical points on adjacent waves.**

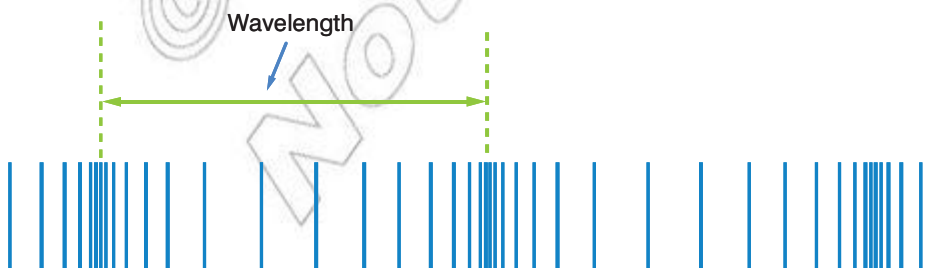
For example, it is the distance from one peak to another, or from one compression to another. Wavelength is given the symbol  $\lambda$  (lambda); this is the Greek letter l.

As wavelength is a distance it is measured in metres (m).



**Figure 8.18** Wavelength

Again, plotting a displacement against distance graph allows wavelength to be easily determined.



**Figure 8.19** Wavelength of a longitudinal wave

**KEY WORDS**

**frequency** *the number of waves passing each second*

**Hertz** *the unit of frequency*

**reciprocal** *the inverse of a number which when multiplied by the original number equals 1*

**time period** *the time taken for a complete wave to pass a given point*

**wave equation** *equation relating wave speed, frequency and wavelength*

**electromagnetic waves** *waves that comprise vibrations of electric and magnetic fields*

**mechanical waves** *waves that comprise a series of vibrations of matter*

**seismic waves** *waves that travel through the Earth, produced by earthquakes*

**DID YOU KNOW?**

The reciprocal of  $x$  is equal to  $1/x$ . For example, the reciprocal of 5 is one fifth ( $1/5$  or 0.2), and the reciprocal of 0.25 is 1 divided by 0.25, or 4.

**Activity 8.5: Time periods**

Find the time period for the following waves from their frequency:

- 20 Hz
- 3 kHz
- 0.2 Hz

Find the frequency of the wave from the following time periods:

- 0.4 s
- 0.2 ms
- 100 s

**Frequency ( $f$ )**

Frequency is defined as:

- The number of complete waves passing a given point per second.

This can be determined by the number of crests or compressions that pass a given point per second. The higher the **frequency**, the greater the number of waves per second.

Frequency is given the symbol  $f$  and is measured in **hertz** (Hz). A frequency of 10 Hz would mean 10 waves per second. The hertz is the SI derived unit for frequency.

**Time period ( $T$ )**

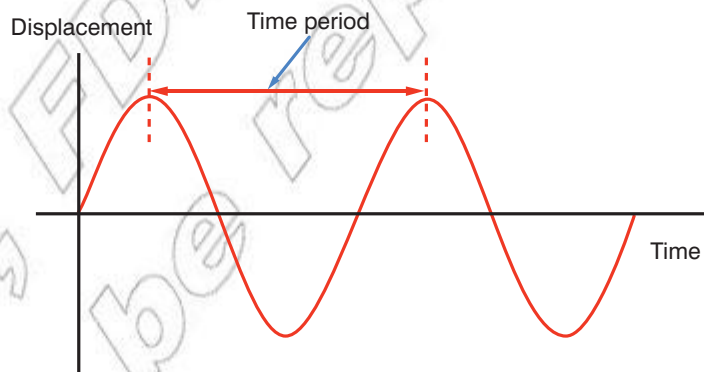
Time period is defined as:

- The time taken for one complete wave to pass a given point.

This is the time taken for one complete particle vibration or oscillation. It is given the symbol  $T$  (or occasionally 'T').

As **time period** is just a measure of duration it is measured in seconds (s).

If you plot a slightly different graph of particle displacement (against time) then the time period is the time between two peaks.



**Figure 8.20** Time period

There are two important equations linking these terms. The first links frequency and time period.

If you consider a wave with a frequency of 4 Hz this would mean four waves passing a point per second. Each wave would therefore take 0.25 second to pass the point. The time period would be 0.25 s. The time period is the **reciprocal** of the frequency. A wave with a frequency of 10 Hz would have a time period of  $1/10$  or 0.1 s. In terms of an equation, we get:

- frequency = 1 / time period**
- $f = 1 / T$

This also means  $T = 1/f$ .

Powers of ten prefixes are often used to describe frequencies and time periods of waves. Some common examples are listed in Table 8.1

Table 8.1 Common powers of ten prefixes

Prefix	Name	Value	Power	Example
G	Giga	$\times 1\,000\,000\,000$	$\times 10^9$	6.5 GHz = 6 500 000 000 Hz
M	Mega	$\times 1\,000\,000$	$\times 10^6$	3 MHz = 3 000 000 Hz
k	Kilo	$\times 1000$	$\times 10^3$	4.2 kHz = 4200 Hz
m	Milli	$\times 0.001$	$\times 10^{-3}$	6 ms = 0.006 s
$\mu$	Micro	$\times 0.000\,001$	$\times 10^{-6}$	40 $\mu$ s = 0.000 040 s
n	Nano	$\times 0.000\,000\,001$	$\times 10^{-9}$	8 nm = 0.000 000 008 m

The second equation is so important in our dealings with waves that it is often simply called the **wave equation**. It relates wave speed, frequency and wavelength.

- **Wave speed = frequency  $\times$  wavelength**
- $v = f\lambda$

We will look at this in more detail in Section 8.3.

### Mechanical vs. electromagnetic waves

So far whenever we've been discussing waves we have talked about particle vibrations within the medium through which the wave is travelling. However, some waves can also travel through a vacuum; there are no particles in a vacuum and so something else must be happening.

We call waves that travel through a material as vibrations of the material **mechanical waves**. Here the particles in the material (water, wood, air, etc.) vibrate. It is these vibrations that form the wave. All mechanical waves require a medium to travel through. They include sound waves, water waves and seismic waves.

**Electromagnetic waves**, such as light, radio and x-rays, do not require a medium to travel through. They are comprised of vibrating electric and magnetic fields. There are no particle vibrations at all. This means electromagnetic waves are able to travel through a vacuum and when they travel through a medium there are no particle vibrations inside that medium.

### Examples of mechanical waves

There are lots of examples of different **mechanical waves**. We will look at sound waves in Section 8.4. In this section we will look at two types in more detail, water waves and **seismic waves**.

#### Water waves

Waves that travel on the surface of water can be thought of as *transverse* waves. However, there is often a slight drift in the direction of wave motion, so they are not perfect transverse waves.

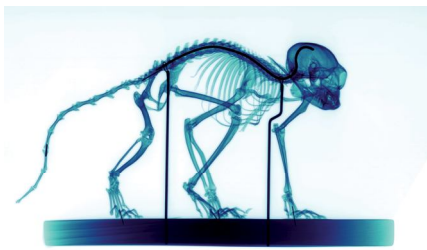
If you throw a stone into a pond you can see ripples as crests and troughs travelling out from the splash. If you poke a stick up and

### Activity 8.6: Electromagnetic spectrum chart

In the text, we have touched only briefly on some parts of the electromagnetic spectrum. Some aspects have been missed out almost entirely – for example, the importance of electromagnetic radiation in astronomy.

Your task, together with the rest of the class, is to produce a large, illustrated chart of the electromagnetic spectrum. Your chart will show all parts of the spectrum, and show uses, hazards, production and detection.

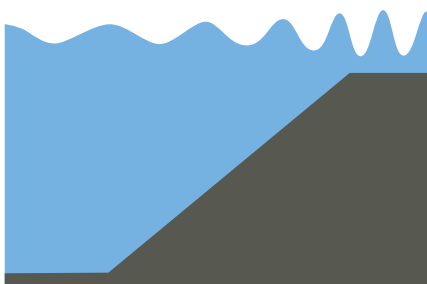
- Decide how you will share out the work. Perhaps different groups will take different parts of the spectrum (infra-red, visible, etc). Perhaps you will look for useful material related to different uses of radiation (industry, astronomy, medicine, etc.).
- When you have gathered images and other information, join together to make a long chart of the complete spectrum. Include on it scales of frequency and wavelength.



**Figure 8.21** X-ray of a marmoset monkey, taken to see how its skeleton compares with other, related species



**Figure 8.22** Water waves on a pond



**Figure 8.23** Water waves slow down but get taller as the water gets shallower.

#### DID YOU KNOW?

The speed of water waves is given by the equation;  $v = \sqrt{gd}$ ,  $v$  = wave speed in m/s,  $g$  = gravitational field strength in N/kg = 10 N/kg and  $d$  = depth of water in m.

down in the water you can create continuous waves travelling out from the source (the stick).

Water waves arise due to the surface tension on the water. As some of the water molecules are pushed down they pull their neighbouring particles down and a trough is created; this then travels away from the source.

The speed of water waves depends on the *depth* of the water. As the depth of the water increases, so does the wave speed. In deep water, water waves can travel very fast (in hundreds of km/h).

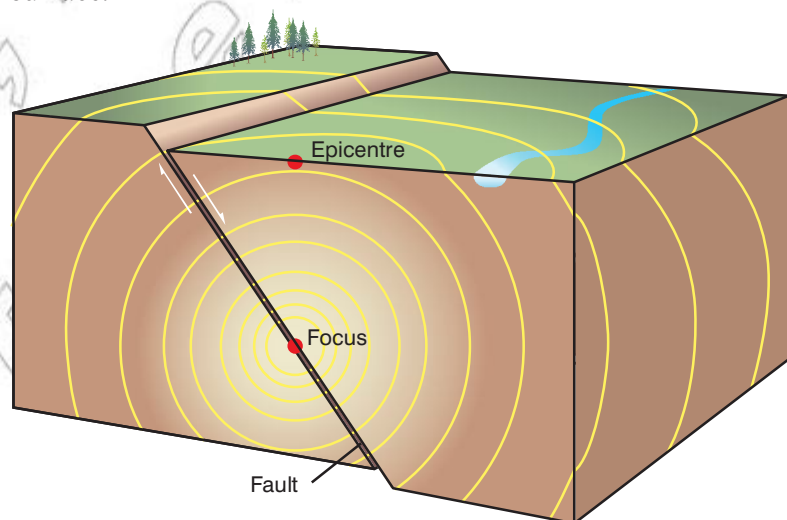
As water waves enter shallower water their speed reduces, so the waves bunch up, the wavelength gets shorter but the amplitude increases.

An easy way to remember this is to use: SSSS Water Waves, shallower, shorter, steeper and slower.

Most water waves on the open sea are caused by the action of the wind on the surface of the water. **Tsunamis** are different types of water wave created by changes to the ocean floor or the coastline (often due to earthquakes). In deep water, tsunamis are not really noticeable. They travel very fast but have a long wavelength and small amplitude. As they approach land they slow down and can grow to massive heights.

#### Seismic waves

Seismic waves are produced by earthquakes. They travel out from the **focus** in all directions throughout the Earth. It is these waves that usually cause the damage to buildings when they reach the surface.



**Figure 8.24** Seismic waves travelling out from an earthquake

There are three types of seismic waves: L-waves, P-waves and S-waves. L-waves are complex types of rolling wave, which travel along the surface of the Earth and cause the most damage to buildings.

P-waves and S-waves travel through the Earth. It is the different properties of these two waves that enable us to not only determine

the exact location of the earthquake but also the structure of the interior of the Earth.

The P in P-waves stands for **primary**, or **pressure**. P-waves are an example of **longitudinal** waves and travel very fast (around 7000 m/s, depending on the medium). They often arrive first (hence primary waves) as they are faster than S-waves.

P-waves are able to travel through both the solid and liquid parts of the Earth's interior.

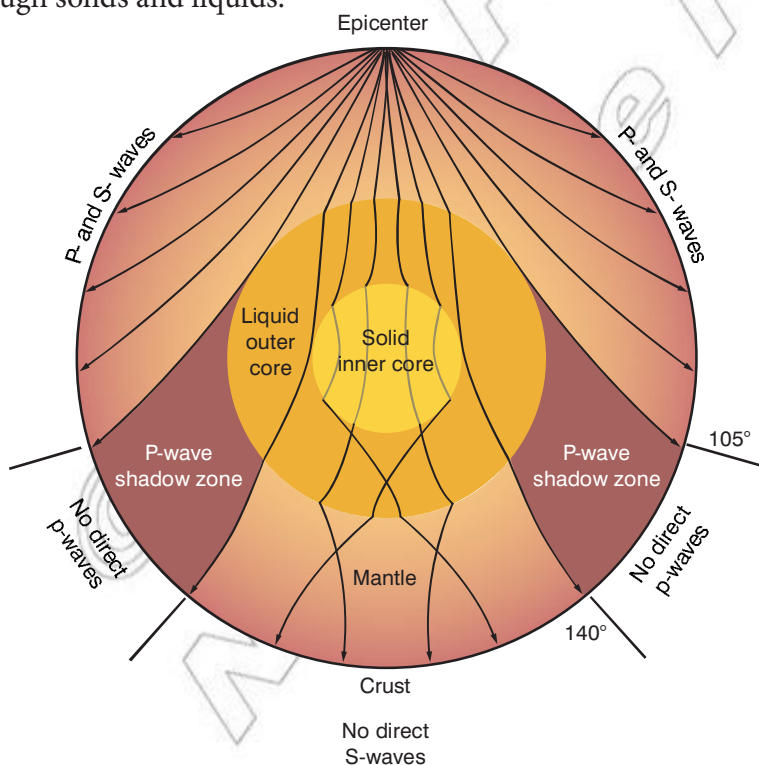
The S in S-waves stands for **secondary**, or **shear**. S-waves are an example of **transverse** waves and still travel fast (around 4000 m/s, depending on the medium), just not as fast as P-waves.

S-waves are only able to travel through the solid parts of the Earth's interior.

Different stations around the Earth record when the P-waves and S-waves arrive. The time delay between the waves and data collected from other stations can be used to work out the exact location of the focus. For example, if three stations A, B and C calculate the focus is 1000 km, 800 km and 500 km away from them, respectively, the exact position can be determined through **triangulation**.

In addition to determining the location, we said earlier that the differences between P- and S-waves allow us to determine information about the structure of the Earth.

This is a very complex process but it relies on the fact that S-waves are only able to travel through solid, whereas P-waves can travel through solids and liquids.



**Figure 8.27** Using seismic waves to determine to structure of the Earth

As the waves travel through the Earth differences in the **density** of the medium cause the waves to bend. It is this bending and the

### Think about this...

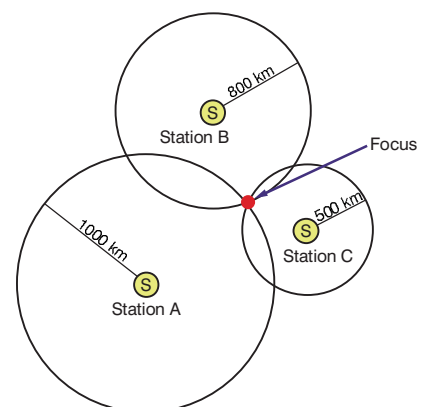
When water waves approach the coastline friction with the sea bed changes their characteristics. This leads to the wave rolling over itself and breaking onto the sea front (in this case it ceases to be a transverse wave).

### DID YOU KNOW?

The fastest documented tsunami was created by an earthquake in Chile in May 1960. The waves travelled the 11 000 km to New Zealand in around 12 hours. That's an average speed of around 900 km/h!



**Figure 8.25** Understanding earthquakes might help predict them and so save lives.



**Figure 8.26** Using triangulation to determine the location of the focus



**DID YOU KNOW?**

Other examples of mechanical waves include vibrations on strings and springs. These vibrations are used in musical instruments.

**KEY WORDS**

**focus** *the underground point of origin of an earthquake*

**tsunamis** *huge water waves on the open sea often caused by earthquakes*

**P-waves (primary or pressure)** *a type of longitudinal seismic wave that can travel through the solid and liquid parts of the Earth's structure*

**S-waves (secondary or shear)** *a type of transverse seismic wave that can only travel through the solid parts of the Earth's structure*

**triangulation** *using measurements from three positions to work out an exact point*

complete lack of S-waves on the opposite side of the Earth that allows scientists to deduce that Earth must have a liquid outer core and a solid inner core. Complex mathematics is used to determine the dimensions of the core and the changes in density between different layers inside the Earth.

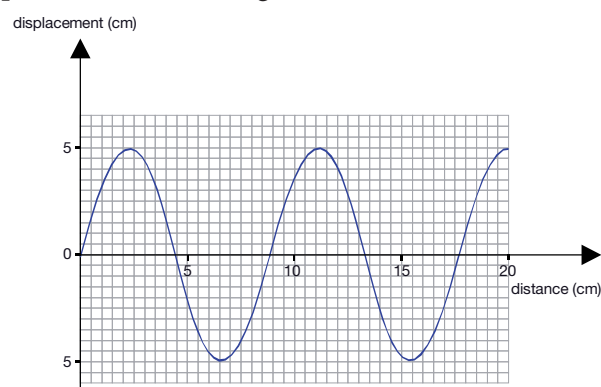
**Summary**

In this section you have learnt that:

- The amplitude of a wave is the maximum displacement from the equilibrium position.
- The wavelength of a wave is the minimum distance from two identical points on adjacent waves (e.g. peak to peak).
- The frequency of a wave is the number of waves passing a given point per second.
- The time period of a wave is the time taken for one complete wave to pass a given point.
- Mechanical waves are waves that comprise a series of vibrations of matter.
- Examples of mechanical waves include water waves, sound waves and seismic waves.
- Electromagnetic waves comprise vibrations of electric and magnetic fields. No particles are required and so electromagnetic waves can travel through a vacuum.
- Electromagnetic waves form a family of waves called the electromagnetic spectrum.

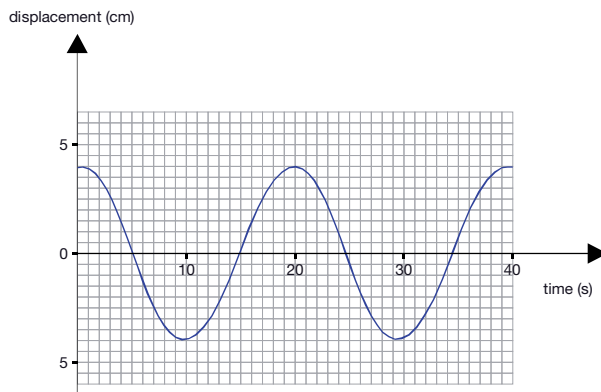
**Review questions**

1. Define the terms amplitude, wavelength, frequency and time period.
2. Make a scale drawing of a wave with amplitude 2 cm and wavelength 8 cm. Mark the amplitude and the wavelength.
3. Look at the wave shown in Figure 8.28. What are the values of its amplitude and wavelength?



**Figure 8.28**

4. Look at the wave shown in Figure 8.29. What are the values of its amplitude and period?



**Figure 8.29**

5. A wave has a frequency of 400 Hz. What is its period? Give your answer in seconds and milliseconds.
6. A wave has a period of 20  $\mu\text{s}$  (microseconds). What is its frequency?
7. Describe an electromagnetic wave.
8. Describe the similarities and differences between P-waves and S-waves.

### 8.3 Properties of waves

By the end of this section you should be able to:

- State the wave equation and use it to solve problems.
- Describe the characteristic properties of waves, including reflection, refraction, diffraction and interference.
- Define the terms diffraction and interference.

#### The wave equation

We met the wave equation back in Section 8.2.

wave speed = frequency  $\times$  wavelength

$$v = f\lambda$$

$v$  = wave speed in m/s.

$f$  = frequency in Hz.

$\lambda$  = wavelength in m.

This equation can't be derived in the traditional sense but it is more a case of working it through logically from the definitions of  $v$ ,  $f$  and  $\lambda$ .

If a wave has a frequency of 10 Hz it will produce 10 waves per second. If the wavelength of each wave is 2 m then it follows logically that the train of waves created in one second would be 20 m long.

**KEY WORDS**

**diffraction** *the spreading out of waves when they pass through a gap or around an obstacle*

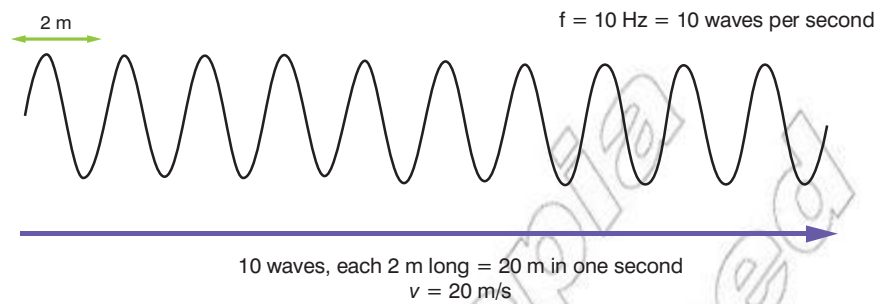
**interference** *when two or more waves pass through the same point and combine to either add up or cancel each other out*

**reflection** *when waves bounce off a fixed surface and change direction*

**refraction** *when waves change speed as they travel from one medium to another and hence change direction*

**wave fronts** *lines used to represent wave crests*

This is the distance travelled by the wave in one second, or the wave speed.



**Figure 8.30** Showing how  $v = f\lambda$

For example, if a wave has a wavelength of 3 cm and a frequency of 11 kHz its speed can be determined:

$v = f\lambda$  *State principle or equation to be used (the wave equation)*

$v = 11\,000 \text{ Hz} \times 0.03 \text{ m}$  *Substitute in known values and complete calculation*

$v = 330 \text{ m/s}$  *Clearly state the answer with unit*

Notice that wavelength must be in m and frequency in Hz.

**Worked example**

The two students in Figure 8.31 measure the waves passing the end of a pier. They measure the wavelength as 5 m and there were nine waves passing the pier per minute. To calculate the wave speed we must first determine the frequency. Nine waves in one minute means nine waves in 60 seconds so:

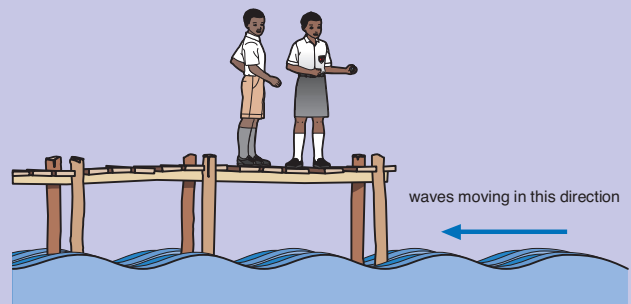
$9 / 60 = 0.15$  waves per second, so the frequency is 0.15 Hz.

We can now use the standard wave equation:

$v = f\lambda$  *State principle or equation to be used (the wave equation)*

$v = 0.15 \text{ Hz} \times 5 \text{ m}$  *Substitute in known values and complete calculation*

$v = 0.75 \text{ m/s}$  *Clearly state the answer with unit*



**Figure 8.31** These students are calculating the speed of the waves as they pass the pier

**Activity 8.7: Using the wave equation**

Complete the following table:

Wave speed (m/s)	Frequency (Hz)	Wavelength (m)	Time period (s)
	400	2	
360		4.5	
1200			0.005

The wave equation may be also applied to electromagnetic waves, in which case the equation changes slightly to:

$c = f\lambda$

$c =$  speed of light in a vacuum ( $3 \times 10^8 \text{ m/s}$ ).

**Worked example**

A water wave travels at a speed of 80 m/s with a wavelength of 20 m. Calculate the time period of the wave.

In order to find the time period we must first find the frequency of the wave:

$$v = f\lambda \text{ State principle or equation to be used (the wave equation)}$$

$$f = v / \lambda \text{ Rearrange equation to make } f \text{ the subject}$$

$$f = 80 \text{ m/s} / 20 \text{ m} \text{ Substitute in known values and complete calculation}$$

$$f = 4 \text{ Hz} \text{ Clearly state the answer with unit}$$

Time period is the reciprocal of the frequency so:

$$T = 1 / f \text{ State principle or equation to be used}$$

$$T = 1 / 4 \text{ Hz} \text{ Substitute in known values and complete calculation}$$

$$T = 0.25 \text{ s} \text{ Clearly state the answer with unit}$$

**Worked example**

A radio station transmits at a frequency of 97.0 MHz. Calculate its wavelength.

$$c = f\lambda \text{ State principle or equation to be used (the wave equation applied to electromagnetic waves)}$$

$$\lambda = c / f \text{ Rearrange equation to make } \lambda \text{ the subject}$$

In this case the frequency is 97.0 MHz or 97 million Hz.

$$\lambda = 3 \times 10^8 \text{ m/s} / 97 \times 10^6 \text{ Hz} \text{ Substitute in known values and complete calculation}$$

$$\lambda = 3.1 \text{ m.} \text{ Clearly state the answer with unit}$$

**Wave behaviour**

All types of wave exhibit certain behaviour; they exhibit **reflection**, **refraction**, **diffraction** and **interference**.

**Reflection**

**Reflection** occurs when a wave reaches a fixed surface. The wave cannot pass through the surface; instead, it reflects off it, so that its direction changes. Figure 8.32 shows what happens when circular ripples in a ripple tank reflect off a straight barrier.

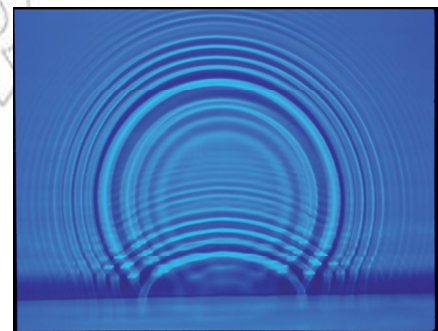
- The ripples spread out as circles from the source.
- After they have reflected from the barrier, they are still circular. They continue to spread out but they are travelling in the opposite direction.

In a picture like Figure 8.32, we are looking down on the ripples from above. We see the pattern of the wave crests; if we draw lines to represent these crests, we call them **wave fronts**. Figure 8.33 shows straight wave fronts reflecting off a straight barrier that is at an angle. The barrier is at  $45^\circ$  to the ripples arriving from the left; the reflected ripples have been reflected through  $90^\circ$ .

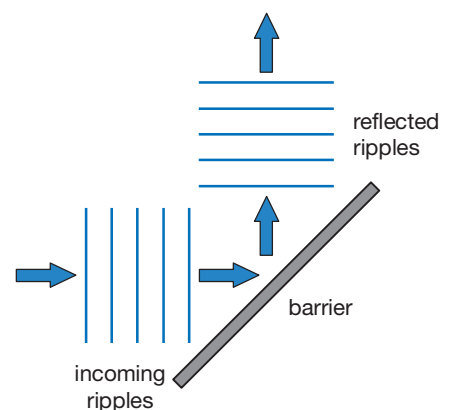
Figure 8.33 helps us to understand the first law of reflection of light – the angle of incidence equals the angle of reflection.

How are waves affected by a curved reflector? At each point on the surface of a curved reflector, the waves obey the law of reflection; that is, they reflect as if the surface at that point was flat.

Figure 8.34(a) shows the effect when plane (flat) ripples reach a concave reflector. The ripples are reflected inwards so that they converge at a point (we say that they are focused by the reflector).



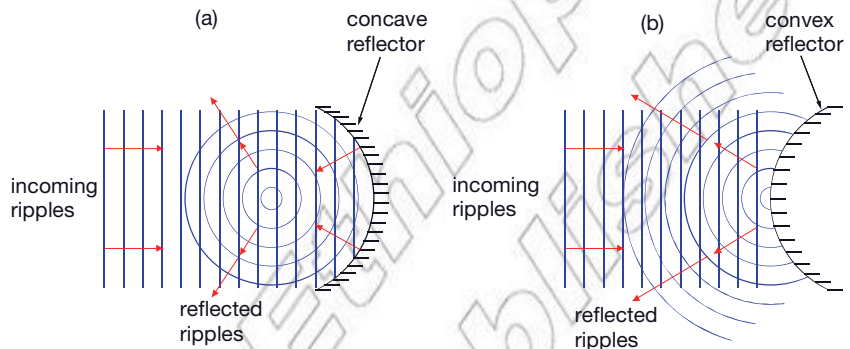
**Figure 8.32** Ripples in a ripple tank reflect off a straight barrier



**Figure 8.33** The lines are called wave fronts; here they are reflecting off a straight barrier

Figure 8.34(b) shows how ripples are affected by a convex reflector; in this case, the straight ripples are reflected so that they become curved. They take the form of circular ripples spreading out as though they were coming from a point on the other side of the barrier.

Figure 8.34(a) also tells us how circular ripples will be affected by a concave reflector. If they start from the focus of the reflector, they will be reflected so that they become straight ripples. (To see this, simply reverse the arrows in the diagram.)

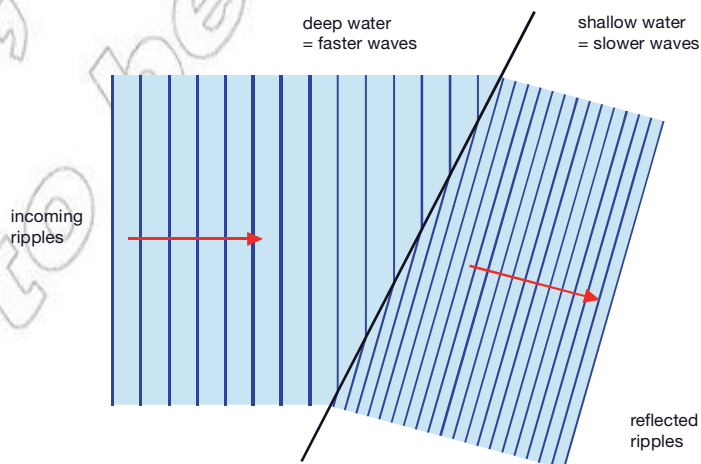


**Figure 8.34** Showing how plane ripples are reflected by (a) a concave reflector; (b) a convex reflector

### Refraction

The word *refraction* means *breaking*. Refraction is a property of all waves (light, sound, etc.). It happens when waves change speed as they move from one material to another.

Refraction can be shown using a ripple tank. Ripples travel more slowly in shallower water than in deeper water, because they drag on the bottom. A shallow area can be created in the tank by placing a sheet of glass in the tank; typically, the water is 8 mm deep, but only 3 mm deep above the glass.



**Figure 8.35** Wave fronts change direction when their speed changes

Figure 8.35 shows the pattern that results when the boundary between the deep and shallow water is at an angle to the wave fronts. Things to notice:

- The ripples change direction as they enter the shallower water.
- The ripples are closer together in the shallower water – their wavelength has decreased.

You will learn more about refraction of light in Grade 10.

## Introduction to diffraction and interference

**Diffraction** and **interference** are behaviours totally unique to waves. Essentially diffraction is the spreading out of waves when they travel through gaps or around obstacles, whereas interference is when two waves pass through each other and either add up or cancel each other out.

### Diffraction

Imagine you are sitting in a room. The door is open, and you can hear music coming from the radio in the next room. You cannot see the radio, but the sound waves it produces pass through the door and spread out into the room you are in. This spreading out is an example of a wave phenomenon called diffraction.

Diffraction occurs when a wave passes the edge of an obstacle, or through a gap. It can be investigated using a ripple tank. Figure 8.36 shows what happens when ripples reach a barrier with a gap in it. From the photographs you can see the following:

- The ripples spread out into the space beyond the gap.
- The narrow gap has more effect than the wide one – there is more spreading out with the narrower gap.

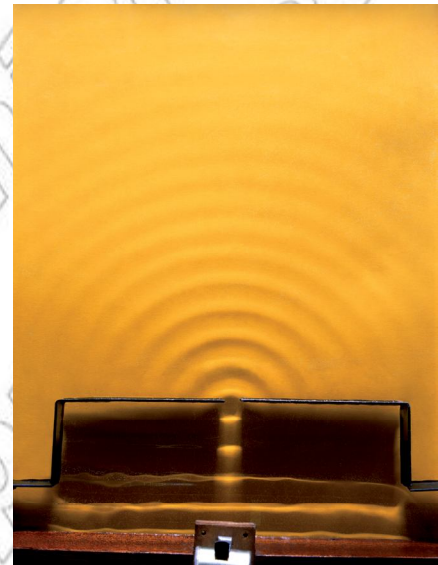
The effect of diffraction is greatest when the width of the gap is the same as the wavelength of the waves, as in Figure 8.36(a). A bigger gap has less effect.

Why do we not notice diffraction of light? The wavelength of light is very short – less than one-millionth of a metre. This means that a very tiny gap is needed to diffract light – light waves will not be noticeably diffracted as they pass through a doorway. In fact, light is diffracted by very small gaps or obstacles. Figure 8.37 shows the Moon hidden behind a church spire. The photo was taken at a time when there were many tiny grains of pollen in the atmosphere, and the light from the Moon is being diffracted by these, causing a ‘halo’ around it. The size of the pollen grains is similar to the wavelength of light.

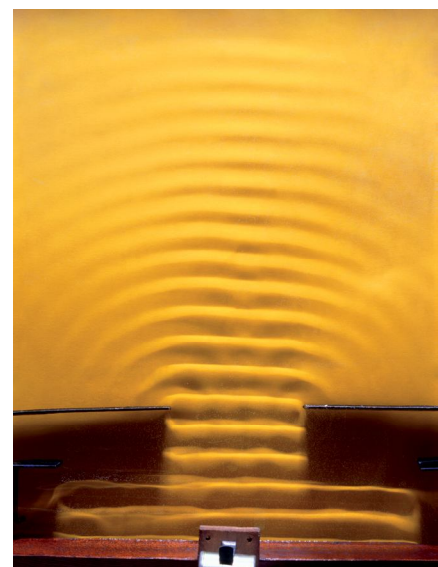
### Activity 8.8: Observing diffraction of light

Grains of talcum powder are very small – similar to the wavelength of light. They can diffract light to form a pattern like the halo shown in Figure 8.37.

- Find two glass microscope slides.
- Sprinkle a very little talcum powder on one slide. Press the second slide on top of the first, and slide it around to give a thin film of powder between the two slides.
- Hold the double slide close to your eye and look at it through a distant lamp. Can you see a diffraction halo around the lamp?



(a)



(b)

**Figure 8.36** Diffraction of ripples as they pass through a gap in a ripple tank; the gap in (a) is similar in size to the wavelength of the ripples; in (b) it is much bigger.



**Figure 8.37** You may have seen a 'halo' like this around the Moon, or around the Sun at sunset. It is caused by tiny pollen grains or water droplets in the air, diffracting the light

## Interference

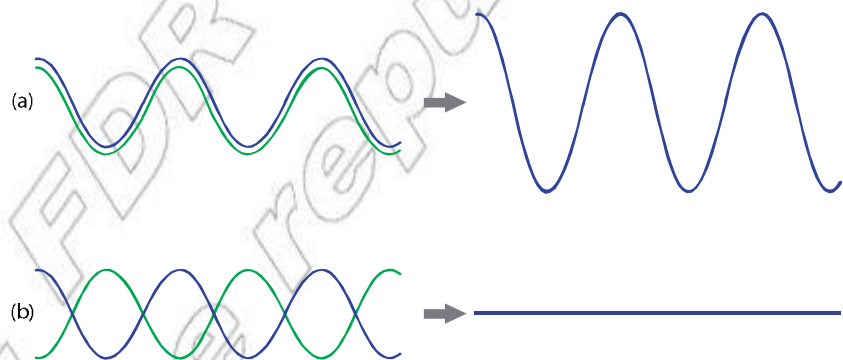
What happens when two waves meet? A strange feature of waves is that they pass straight through each other. Here is an example with two sets of light waves. Switch on two torches (flashlights). Direct their beams so that they cross over. The light waves from one torch pass straight through the light waves from the other. If light was made of particles, they would bounce off each other.

Now we need to think about what happens at the point where the paths of the two sets of waves cross.

## Constructive and destructive interference

To observe **interference**, we need two sets of waves. Figure 8.38 shows that there are two kinds of interference:

- If the two waves are in phase (in step) with each other, they combine to make a bigger wave, with twice the amplitude. This is called **constructive interference**.
- If the two waves are out of phase with each other, they cancel each other, so that there is no wave. This is called **destructive interference**.



**Figure 8.38** Two waves can interfere (a) constructively, or (b) destructively

Note that the two sets of waves must have exactly the same wavelength (and frequency) if they are to interfere like this. Also, their amplitudes should be the same if they are going to cancel exactly.

It is difficult to see interference with light. One example is the coloured patterns you see where there is a thin film of oil on a puddle of water, or if you look at the shiny surface of a compact disc (CD). Where you see a bright red colour, for example, red light waves are reflecting off the surfaces of the oil or CD and interfering constructively to produce a bright colour. Different colours interfere at different angles to produce the pattern.

## Interference of ripples

A ripple tank can show the interference patterns produced when two sets of ripples meet. There are two ways to do this:

- Use two vibrating dippers to produce two sets of circular ripples. Where the ripples overlap, they produce a characteristic pattern (Figure 8.39). At some points, the ripples add together (interfere constructively) to produce a large effect. In between, they cancel out so that the surface of the water is unperturbed.
- Alternatively, use a straight vibrating source to produce parallel ripples. Direct these at a barrier with two gaps; the ripples pass through the gaps and diffract into the space beyond. Here, they overlap to produce an interference pattern similar to the one shown in the photograph.



**Figure 8.39** The two vibrating balls produce sets of ripples that overlap with each other to produce an interference pattern. At the top of the photo you can clearly see regions where the ripples are cancelling out (destructive interference). In between are regions of constructive interference

### Summary

In this section you learnt that:

- The wave equation is  $v = f\lambda$ .
- When waves bounce off a surface, this is called reflection.
- When waves travel from one medium to another, their speed may change and so they may bend. This is called refraction.
- Diffraction is the spreading out of waves when they pass through a gap or around an obstacle.
- Interference is when two or more waves pass through the same point and either add up or cancel each other out.

### KEY WORDS

#### constructive interference

where two waves are in phase with each other and combine to make a bigger wave

#### destructive interference

where two waves are out of phase with each other and combine to cancel each other out

### Review questions

1. A guitarist plays a high note; its frequency is 2000 Hz. The sound waves produced have a wavelength of 0.17 m. What is the speed of sound in air?
2. A drummer plays a note with a frequency of 85 Hz. What is the wavelength of this sound wave in air? (Speed of sound in air =  $340 \text{ m s}^{-1}$ .)
3. A radio station broadcasts an FM signal with a wavelength of 2.85 m. If the speed of radio waves is  $3 \times 10^8 \text{ m s}^{-1}$ , what is the frequency of the FM signal?
4. Explain the terms reflection, refraction, diffraction and interference.



**KEY WORDS**

**longitudinal mechanical waves** *waves comprising vibrations in matter where the vibrations are parallel to the direction of wave motion*

**audible range** *the range of sound frequencies that can be detected by the ear*

**ear drums** *membranes in the ear that vibrate when a sound wave enters the ear canal*

**Activity 8.9: To show that sound is caused by vibration**

- Stretch a piece of elastic and pluck it. Note the way it moves.
- Press one end of a ruler down on a table. Twang the free end.
- Strike the prongs of a tuning fork against a rubber stopper; note how they move backwards and forwards. Let one of the prongs touch a table-tennis ball hanging on a thread. The ball moves. Touch the still surface of water with the moving prongs; ripples spread out across the surface.

**Table 8.2** Vibrations in musical instruments

Instrument	Vibration
Drums	Drum skin
Piano	Strings
Guitar, violin, etc.	Strings and body of instrument
Trumpet and trombone	Lips (causing the air inside to vibrate)

**8.4 Sound waves**

By the end of this section you should be able to:

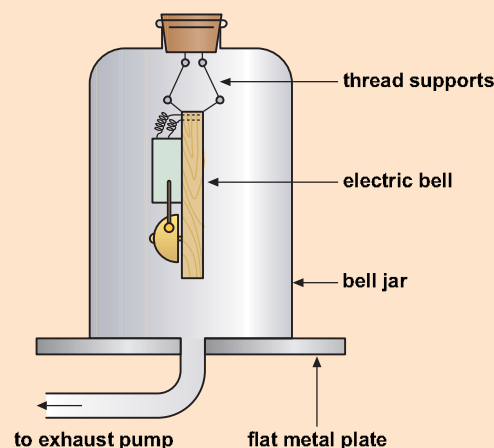
- Identify sound waves as longitudinal mechanical waves and describe how the waves are produced and how they propagate.
- Compare the speed of sound in different materials and determine the speed of sound in air at a given temperature.
- Define the intensity of a sound wave and solve problems using the intensity formula.
- Explain the meaning of the terms echo, reverberation, pitch, loudness and quality.
- Explain the reflection and refraction of sound and describe some applications.

Sound waves are **longitudinal mechanical waves**. Sound waves are produced whenever an object vibrates. When you speak your vocal cords in your throat vibrate as the air is pushed over them. Different musical instruments produce sound by making a part of the instrument vibrate.

As sound waves are mechanical waves they require a medium to travel through. Sound obviously travels through air but it also travel through other gases, as well as solids and liquids. Importantly, sound cannot travel through a vacuum.

**Activity 8.10: To find whether sound can pass through a vacuum**

- Hang an electric bell by cotton thread from the stopper of a bell jar (Figure 8.40). Make the bell ring. Place the jar on the plate of an exhaust pump. Can you hear the sound?
- Pump air out of the bell jar, letting the bell ring all the time inside the jar. What do you observe about the sound?
- Let air enter the bell jar again. What happens?



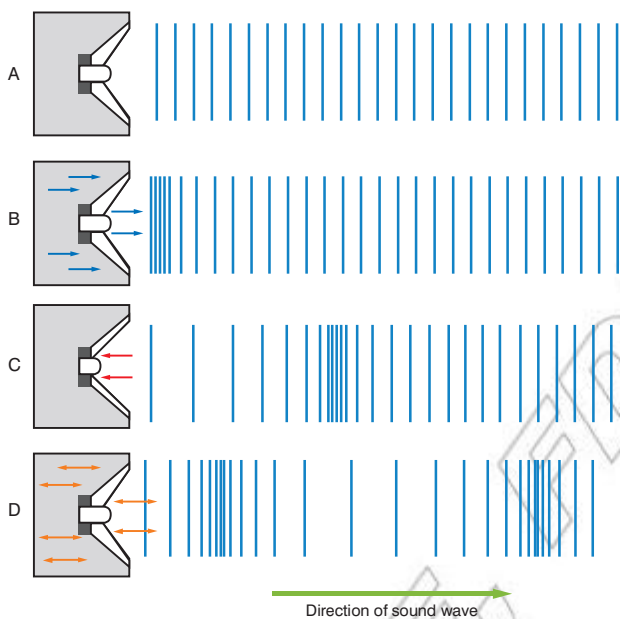
**Figure 8.40** Can sound pass through a vacuum?

It is important to realise that sound waves are longitudinal. We often see pictures of sound waves looking like transverse waves. Remember, this is because a graph of particle displacement against distance or time for both transverse and longitudinal waves looks like Figure 8.41.

Sound waves are a series of compressions and rarefactions and we can see this by conducting a very simple experiment.

If you place a candle in front of a speaker and then play sounds through the speaker (ideally just one tone) you will see the candle flame wobble from side to side.

This shows that the vibrations are parallel to the direction of wave motion. In fact if you think about how the speaker produces the sound then it is even more obvious.



**Figure 8.43** How a speaker produces a sound wave

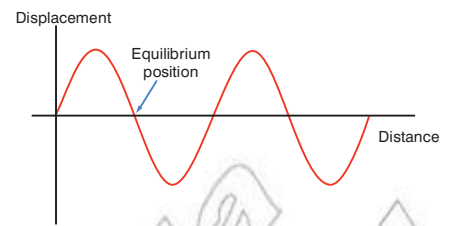
If you look closely at a speaker you will see the speaker cone moving in and out. As it moves out it creates an area of higher pressure as it compresses the air (B). The cone then moves back in and so creates an area of lower pressure, and so a rarefaction (C). This process continues, creating a longitudinal wave (D).

## Hearing

When these vibrations reach our ears they travel down our ear canal and make our **ear drums** vibrate. These vibrations are transmitted to special cells inside your skull, which send a signal to your brain that we interpret as sound.

When we are young we can detect a range of frequencies from around 20 Hz to 20 000 Hz. This is referred to as our **audible range**.

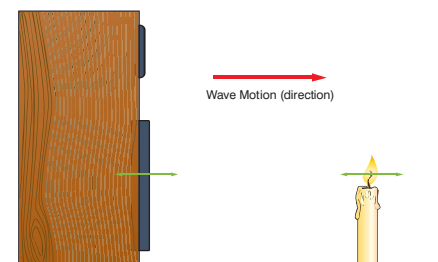
This varies from person to person and factors such as age and exposure to loud music dramatically changes this range. Table 8.3 on the next page shows the audible range of several other animals.



**Figure 8.41** Displacement against distance

### Activity 8.11: Sound travels through many substances

- A string telephone:  
Join the bottoms of two empty tin cans with string. Speak into one tin while a friend listens with the other tin. Keep the string tight so that it presses against the metal. Can sound pass through a string?
- Lay a ticking watch or clock at one end of a table. Now place one ear against the table, at the other end. Can you hear the ticking? Does sound travel better through wood than through air?
- Clap your hands when swimming under water. Can you hear the sound easily? This might be tricky and so it helps if you have a partner who can clap while you swim!



**Figure 8.42** Demonstrating sound waves are longitudinal

**Think about this...**

To help remember the audible range of humans think of 20:20 vision. This is often used to represent good eyesight. Well, humans also have 20:20 hearing, that is 20 Hz to 20 kHz!



Figure 8.44 Different animals have different audible ranges.

Table 8.3 Different audible ranges

Animal	Approximate audible range (Hz)
Human	20–20 000
Bat	10–200 000
Dog	15–40 000
Dolphin	120–110 000

**DID YOU KNOW?**

Elephants can detect very low frequency sound waves. This is used for long-distance communication between herds. Due to its low frequency it has a range of around 10 km.

**The speed of sound**

The speed of sound through air is around 340 m/s; this is around 900 000 times slower than light, but still pretty fast.

In storms thunder and lightning occur at the same time. However, the light travels much faster than the sound. This means we always see the flash of lightning before the sound of thunder arrives. The greater the time delay, the further away the storm.

In fact if we assume the light arrives without any real delay, then for every second between the lightning and the thunder the storm is around 300 m away.

**Activity 8.12: Investigating the range of hearing**

A signal generator connected to a loudspeaker can produce sounds of a known frequency (Figure 8.45).

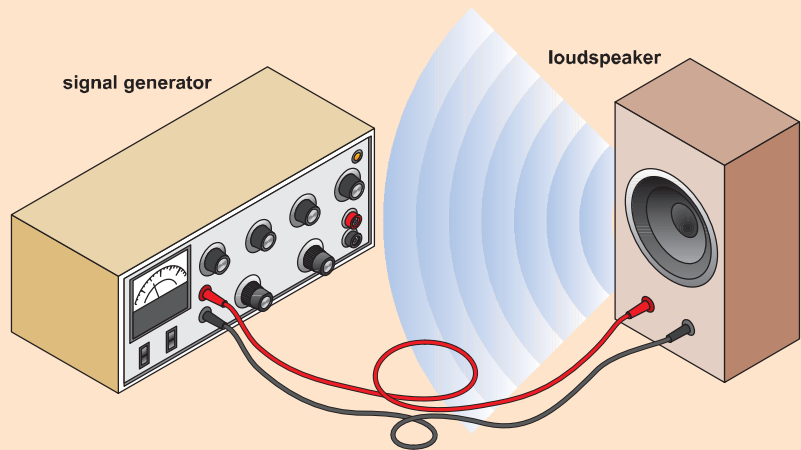


Figure 8.45 Turning the dial on the signal generator changes the frequency of the sound from the loudspeaker.

- Listen as the frequency becomes higher and higher. At what frequency does it become inaudible?
- Repeat as the frequency is reduced.
- Imagine that someone in your class claims to be able to hear frequencies that are higher than you can hear. How could you check that they are telling the truth?
- It is said that younger people can hear higher notes than older people. How could you test this idea?

Sound travels at different speeds through different materials. The speed of sound through water is around five times faster than in air and in metals like iron it is faster still (around 15 times).

**Table 8.4** Speed of sound in different materials

Medium	Speed of sound (m/s)
Dry air at 0°C	331
Dry air at 30°C	349
Moist tropical air	351
Water at 20°C	1484
Seawater at 15°C	1510
Wood	3850
Iron, steel	5000
Glass	5000

In general, the denser the material, the faster the speed of sound. This is because the particles in the medium are closer together and so the vibrations pass from particle to particle much quicker.

When sound waves travel through gases, things are a little more complex due to the motion of the particles. The density of the gas has an effect, and if two gases were at the same temperature then sound would travel faster through the denser gas. However, the temperature of the gas has a significant effect.

When a gas is at a higher temperature the average kinetic energy of the particles is higher. This means on average the particles are moving faster (see Unit 7). The faster the particles are moving, the faster the speed of sound through the gas. This can be seen in Table 8.5.

As air gets warmer the speed of sound through it increases. The speed of sound through any gas may be calculated using the equation below:

$$\bullet \quad v = \sqrt{(\gamma R^* T)}$$

$\gamma$  = the adiabatic index of the gas (a constant for the gas). For air, this equals 1.4.

$R^*$  = another constant for the gas. It equals the molar gas constant / the molar mass ( $R / M$ ). For air, this is  $286 \text{ m}^2/\text{s}^2 \text{ K}$ .

$T$  = the temperature in K.

For air, this can be simplified to:

$$\bullet \quad v = \sqrt{(kT)}$$

where  $k = \gamma \times R^* = 1.4 \times 286 \text{ m}^2/\text{s}^2 \text{ K} = 400 \text{ m}^2/\text{s}^2 \text{ K}$  and so:

$$\bullet \quad v = \sqrt{(400 \times T)}$$

At 25 °C the speed of sound through air may be calculated using this equation:

$$\bullet \quad v = \sqrt{(400 \times T)}$$


**Figure 8.46** A storm

### Activity 8.13: Thunder and lightning

A clap of thunder arrives five seconds after the lightning. How far away is the storm? What would happen to the time delay if the storm were moving towards you?

**Table 8.5** Speed of sound in air

Air temperature (°C)	Speed (m/s)
-20	319
-10	325
0	331
10	337
20	343
30	349

### DID YOU KNOW?

Mach numbers (named after the Austrian physicist Ernst Mach) are often used to quantify the speed of fast moving aircraft. Mach 1 represents the speed of sound, Mach 2 twice the speed of sound, etc. Aircraft travelling at speeds greater than Mach 1 are flying faster than the speed of sound and are said to be supersonic.



**Figure 8.47** Modern jet fighters are able to travel much faster than the speed of sound.

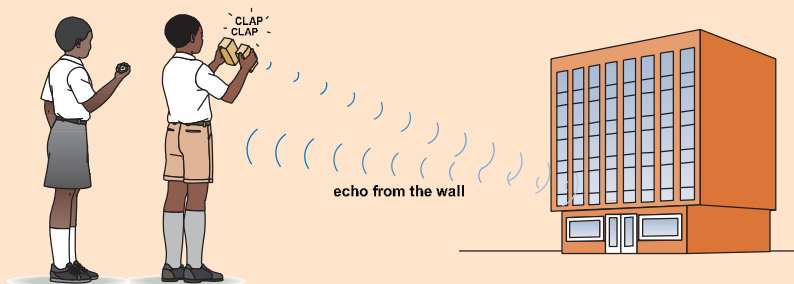
Remember, the temperature must be in K not °C. So, 25 °C = 298 K

- $v = \sqrt{(400 \times 298 \text{ K})}$
- $v = 345 \text{ m/s}$

A simple way to determine the speed of sound is to measure the time it takes for a sound wave to travel a known distance.

### Activity 8.14: Measuring the speed of sound using echoes

- Stand facing a tall wall, at a distance of about 100 m (Figure 8.48). Measure the distance to the wall.
- Clap two blocks of wood together, and listen to the echo. The time interval is too short to measure accurately.
- Now clap the blocks together so that each clap coincides with the echo of the previous one. Using a stopwatch, time a sequence of 10 claps. (Count 0, 1, 2, 3 ... 9, 10.)
- Now you know the time taken for the sound to travel to the wall and back ten times. Use this information to calculate the speed of sound in air.



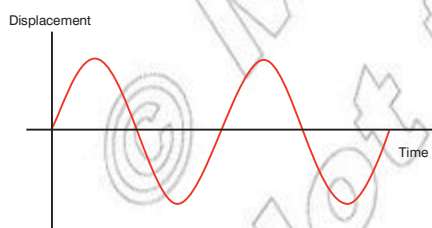
**Figure 8.48** Using echoes to measure the speed of sound

### How do we describe sound waves?

What is the difference between louder and quieter sounds? Or higher pitch and lower pitch sounds? And why does the same note sound different from a violin to a piano? In order to answer these questions we need to be able to observe what is going on in terms of the particles.

Sound waves are longitudinal mechanical waves, but we can use an oscilloscope and microphone to help 'see' sound waves. An oscilloscope produces a trace on the screen that varies depending on the sound entering the microphone. It is essentially a trace of the displacement of the particles against time.

Using an oscilloscope we can see the effect of changing volume and pitch.



**Figure 8.49** The displacement of air particles against time

### Loudness

The **loudness** of a sound depends on the amplitude of the sound wave. The greater the amplitude, the louder the sound.

In louder sounds the particles move further from their equilibrium position.

The loudness of a sound is measured in decibels (or dB). This is a complex scale. It is logarithmic not a linear scale. In other words 40 dB is much more than twice as loud as 20 dB.

**Table 8.6** The loudness of different sounds

Sound	Loudness (decibels)
Whisper	10
Leaves rustling in the wind	17
Shouting	70
Loud music	100
Jet engine	120

### Pitch

The **pitch** of a sound depends on the frequency of the sound wave. The higher the frequency of the sound waves the higher their pitch.

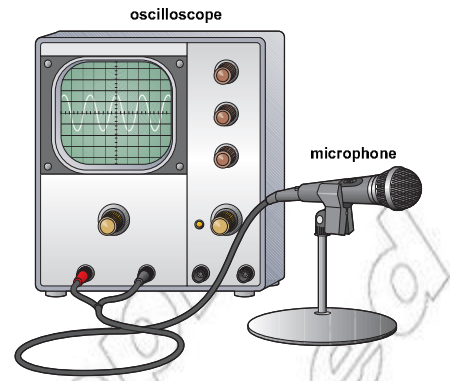
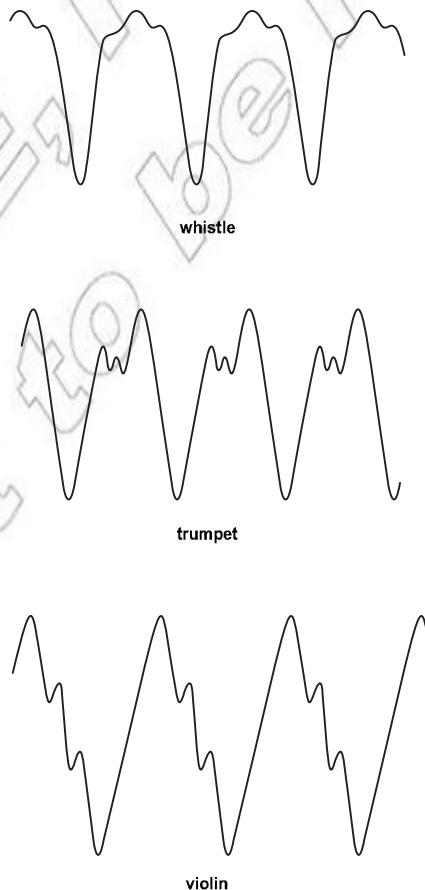
In higher pitch sounds the particles vibrate more often past their equilibrium position per second.

### Timbre (quality)

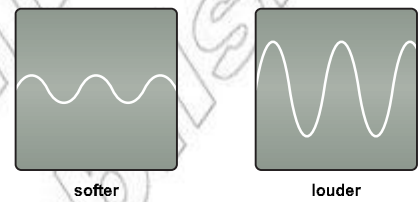
The same note played on different instruments sounds distinctly different. This difference is referred to the **timbre** (or quality) of the sound. Quality does not mean good or bad, it just refers to the difference in the sound.

You can see from Figure 8.53 above that the same note produces a different trace on the oscilloscope. This is because of the complex nature of the number of different vibrations produced by the instrument.

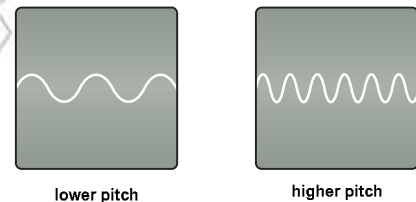
**Figure 8.53** The same note produced by different instruments



**Figure 8.50** A simple oscilloscope



**Figure 8.51** The difference between a loud sound and a quiet sound



**Figure 8.52** The difference between a low pitch sound and a high pitch sound

#### KEY WORDS

**loudness** the audible strength of a sound, which depends on the amplitude of the sound wave

**pitch** highness or lowness of a sound, which depends on the frequency of the sound wave

**timbre** the quality of a sound



Figure 8.54 Different instruments produce different quality notes.

### Activity 8.15: Sounds on a scope

- Connect a signal generator to an oscilloscope and to a loudspeaker. Watch how the trace on the scope changes as the controls of the signal generator are altered.
- The sound is made louder: how does the trace change?
- The frequency is made higher: how does the trace change?
- Connect a microphone to the oscilloscope, in place of the signal generator. Make different sounds in front of the microphone and observe the traces. (Try clapping, whistling, playing an instrument.)

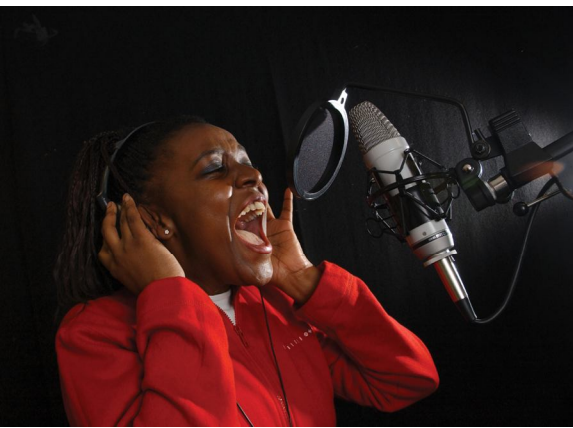


Figure 8.55 It is important to reduce the echo in recording studios.

### Echoes, echoes, echoes, echoes....

Sound, like all waves, is able to reflect off surfaces. A reflection of sound is called an **echo**.

You get the best echoes off solid surfaces, like metal sheets or stone. Softer surfaces tend to absorb the sound waves and so there are reflected less. You might have noticed this inside a cave or inside a building with solid stone walls.

If the sound produced is in an enclosed space it may produce a number of echoes. It sounds like the sound is building up then slowly decaying away. This is called **reverberation**.

This is most noticeable when the source of sound stops but the reflections continue. Each time they reflect off the surface they lose some energy and so the amplitude decreases and the sound becomes quieter.

#### DID YOU KNOW?

“A duck’s quack doesn’t echo” is a much-quoted scientific myth. The truth is that a duck’s quack does, it’s just quite hard to hear due to the shape of the sound wave produced.

### The intensity of sound waves

The further the source of sound is away from you the quieter the sound. This is because the energy is spread out over a much wider area.

This happens with all waves. If you look closely at the ripples on a pond you can see the amplitude of the wave decreases as you get further away from the source.

The **intensity** of any wave is defined as the energy received by each square metre per second. A higher intensity would mean more energy per second falling on each square metre.

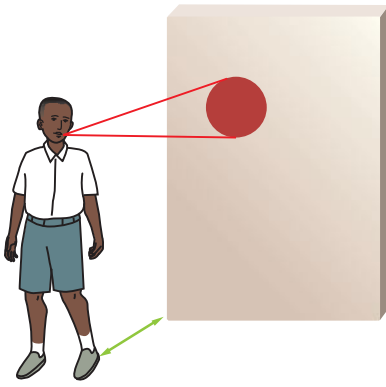
- **Intensity is equal to the energy incident on each square metre of a surface per second.**

This gives us units of intensity as  $W/m^2$ , we use  $W$  as this is just energy per second.

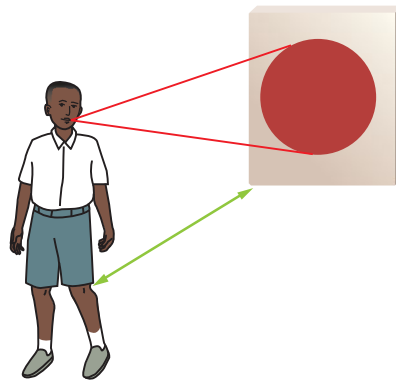
The further away the surface the more the energy gets spread out and so the intensity falls. Imagine standing near a wall and shouting at it (I know it sounds odd!). The sound spreads out as it leaves your mouth and strikes an area of the wall.



Figure 8.56 The ripples get smaller as the energy is spread out.



**Figure 8.57** Stand close to a wall and the intensity is higher.



**Figure 8.58** Stand further away and the intensity drops.

However, if you stand further away the sound has to travel a greater distance before it strikes the wall and so it spreads out to cover a wider area.

The intensity is now lower as the energy per second per square metre has dropped – it's more spread out.

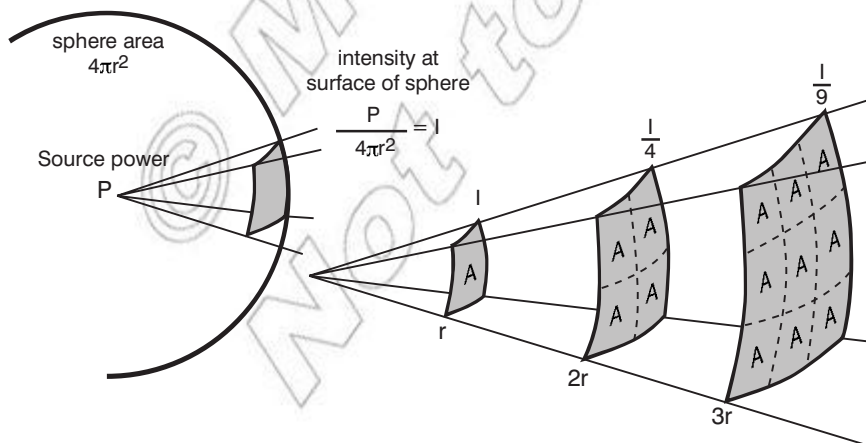
In all cases the intensity of a wave can be determined using the equation below.

- $\text{intensity} = \text{power} / \text{area}$

If we think about the sound travelling out in all directions (in 3D) from a source we can see that the energy spreads out in the shape of a sphere. So in this case the area is the surface area of a sphere (given by  $4\pi r^2$ ). This means the equation becomes:

- $\text{intensity} = \text{power} / \text{area}$
- $I = P / 4\pi r^2$

From this equation we can see that if the wave travels twice as far then the intensity falls to a quarter of its value. Three times as far and it is a ninth. This is because the energy is spread over a much larger area, double the distance and it's four times the area, as shown in Figure 8.59.



**Figure 8.59** Intensity against distance

This kind of relationship is called an **inverse square** relationship. As the distance goes up by a factor of  $x$ , the intensity falls by  $x^2$ . This produces a graph like that in Figure 8.60 on the next page.

### KEY WORDS

**echo** a reflection of a sound wave

**intensity** the energy received by each square metre of a surface per second

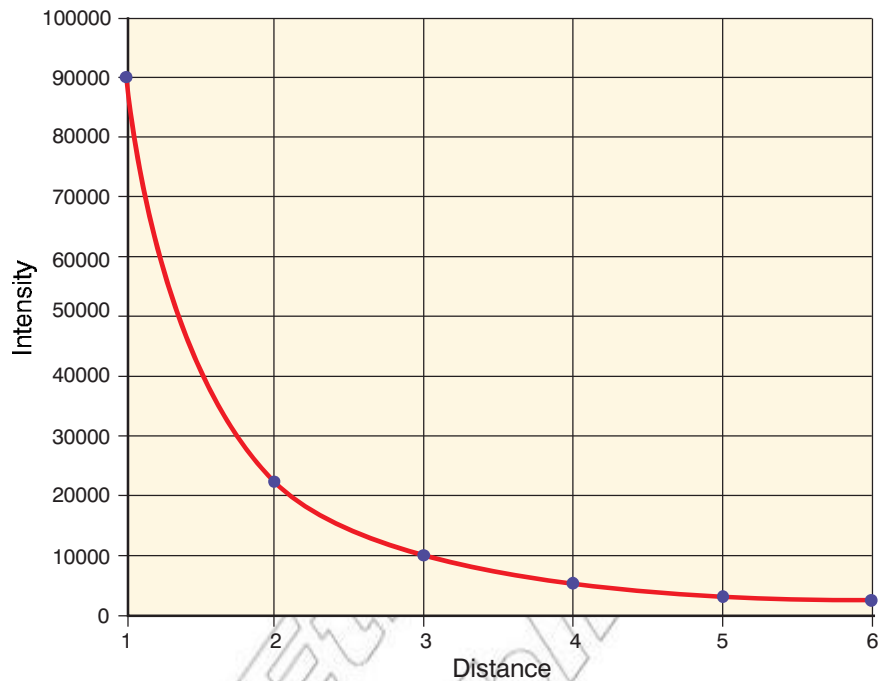
**reverberation** multiple reflection of sound waves in an enclosed space so that the sound continues after the source is cut off

**inverse square relationship** where if one variable increases by a factor of  $x^2$  then the other decreases by a factor of  $x^2$



**Think about this...**

Sound waves speed up as they enter denser materials; this means when they refract they bend towards normal unlike light (which slows down in denser materials).



**Figure 8.60** A graph showing how intensity varies with distance from source.

You will come across a number of inverse square relationships in the next few years.

**KEY WORDS**

**ultrasound** *high frequency sound waves, above human hearing*

**hydrophones** *underwater microphones*

**Worked example**

A speaker has a power output of 150 W. Determine the intensity of the sound 1.5 m from the speaker.

$$I = P / 4\pi r^2 \text{ State principle or equation to be used (intensity for a point source)}$$

$$I = 150 \text{ W} / 4\pi \times (1.5 \text{ m})^2 \text{ Substitute in known values and complete calculation}$$

$$I = 5.3 \text{ W/m}^2 \text{ Clearly state the answer with unit}$$

The intensity of a sound wave is measured to be 0.7 W/m<sup>2</sup> when 2.0 m from the source. Calculate the power of the source.

$$I = P / 4\pi r^2 \text{ State principle or equation to be used (intensity for a point source)}$$

$$P = I \times 4\pi r^2 \text{ Rearrange equation to make P the subject}$$

$$P = 0.7 \text{ W/m}^2 \times 4\pi \times (2.0 \text{ m})^2 \text{ Substitute in known values and complete calculation}$$

$$P = 35 \text{ W} \text{ Clearly state the answer with unit}$$

## Uses of sound waves

Sound waves have many uses, in addition to the obvious uses in communication and music.

Most of these uses depend on the behaviour of the sound waves when they **reflect** or **refract**. Sound, like all waves, reflects off surfaces, but sound waves also reflect off the boundary between materials if there is a change in density between the materials. The greater this change in density the greater the amount of sound reflected.

In Figure 8.61, sound waves refract as they enter a medium with a different density (the red area). You can also see the sound waves reflect off the boundary between the materials (the green arrows).

It is these reflections and refractions that can tell us a great deal about the object and so make sound very useful indeed.

In fact for most uses **ultrasound** is used instead. Ultrasound is just sound waves with a high frequency and so a relatively short wavelength. This means it does not diffract very much and so it remains as a tight focused beam.

Ultrasound is any sound above the audible range of humans. It can be defined as:

- **Sound waves with a high frequency, above human hearing, above 20 kHz.**

One example of the use of sound is SONAR. This stands for SOUND Navigation And Ranging, which is the sound wave equivalent of radar. It is most often used by ships to determine the depth of the sea bed, the location of a shoal of fish, or even the position of an enemy submarine.

Sound is transmitted by the ship and it travels through the water. It reflects off the sea bed and travels back up where it is detected by special underwater microphones called **hydrophones**.

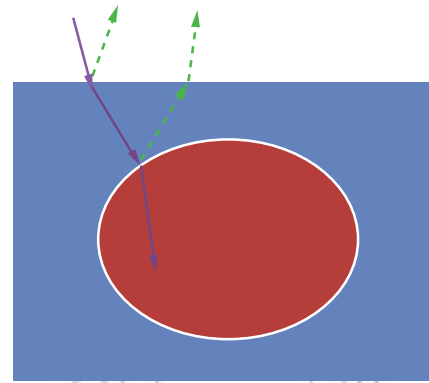
It is then a relatively simple process to determine the distance travelled by the sound using  $\text{distance} = \text{speed of sound through water} \times \text{time taken}$ . The depth is then half this distance as the sound has had to travel there and back!

Ultrasound is also used in pre-natal scanning. Here the ultrasound travels into the womb and reflects off the unborn baby. This sound is harmless (unlike using X-rays) and allows doctors to monitor the progress of the developing baby.

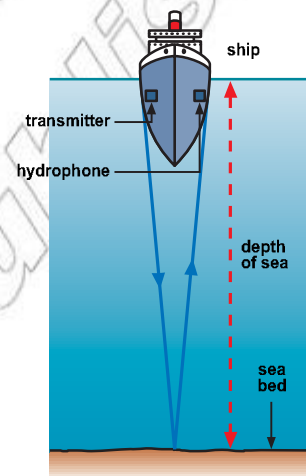
Ultrasound is also used to detect flaws in metals and even to help people park their cars! In each case it is the reflection and refraction of the sound that makes the job possible.

### Activity 8.16: Depth sounding

The speed of sound through sea water is around 1500 m/s. A wave pulse is sent from a ship and takes 0.7 s to return. Calculate the depth of the water.



**Figure 8.61** The reflection and refraction of sound through different materials



**Figure 8.62** Using SONAR to determine the depth of the sea



**Figure 8.63** Using ultrasound to monitor a baby

### Summary

- Sound waves are mechanical longitudinal waves produced when objects vibrate.
- Sound waves travel through different media as a series of compressions and rarefactions.
- In general, sound travels faster in denser materials; however, the warmer the gas the faster the speed of sound through it.
- The amplitude of a sound wave affects its loudness and the frequency of the sound wave its pitch.
- A reflection of sound is called an echo and if several echoes are trapped inside a room or object a reverberation may be heard.
- The intensity of a sound wave is the energy received per square metre of a surface per second.
- Sound has many uses including SONAR and pre-natal scanning. Both rely on the sound waves reflecting and refracting off different materials.

### Review questions

1. Compare the speed of sound through the different materials in the Table 8.4 (speed of sound through materials). Explain the differences in the speed of sound:
  - a) between solids, liquids and gases
  - b) between warm air and cold air.
2. Explain the meaning of the terms loudness, pitch and timbre. Illustrate your explanations with diagrams and examples.
3. A speaker produces a sound output at a power of 500 W. Determine the intensity at:
  - a) 2.0 m
  - b) 4.0 m
  - c) 16 m
4. The intensity of a sound source is measured 3.0 m from the source and it found to be  $4.0 \text{ W/m}^2$ . Calculate the intensity received at:
  - a) 1.0 m
  - b) 5.0 m
5. Describe one possible use of sound waves.

## End of unit questions

- In which type of wave are the vibrations at right angles to the direction of travel?
  - What is the name given to the other type of wave?
  - Describe the vibrations in this type of wave.
  - Give an example of each type of wave.
  - Describe how you would demonstrate each type of wave using a slinky spring.
- Complete the table and draw the following waves to scale:

Wave speed (m/s)	Frequency (Hz)	Wavelength (m)	Time period (s)	Amplitude (m)
720	45			8.0
40			0.05	4.0
	6000	0.002		3.0

- An electromagnetic wave has a wavelength of 10 nm. Calculate its frequency and identify to which part of the electromagnetic spectrum the wave belongs.
- What wave phenomena are described here?
  - A light wave slows down as it passes from air into water; this causes it to change direction.
  - Waves on the sea pass between two high walls into a harbour. They spread out into the space behind the walls.
  - Two alarm sirens are emitting a loud note; at points between the two sirens the sound is very loud, but at other points it is much fainter.
  - An explorer shouts into a dark cave; a fraction of a second later, he hears the sound of his own voice.
- Draw diagrams to illustrate the difference between constructive and destructive interference.
- Two identical waves of amplitude 5 cm meet in a large ripple tank. What will be the amplitude of the combined wave at a point where they interfere constructively? And where they interfere destructively?
- Explain why, if someone is playing a guitar in the next room, you may be able to hear the sound of the guitar through the open doorway, although you cannot see the guitarist because she is round the corner.
- What is meant by an echo?
- A child claps her hands together whilst facing a tall building. The echo reaches her ears after 0.6 s. How far is she from the building? (Speed of sound in air =  $340 \text{ m s}^{-1}$ .)

10. Outline a method of finding the velocity of sound in air.
11. In an experiment to measure the speed of sound in a steel rod, it is found that a sound will travel along a rod of length 2 m in a time of 0.000 4 s. What is the speed of sound in steel?
12. Explain why a flash of lightning is usually seen before the clap of thunder is heard.
13. A ship is sailing in a part of the sea where the bed is 600 m below the ship. The ship uses sonar to detect the seabed. How long will it take a pulse of sound to travel to the seabed and return to the ship? (Speed of sound in water =  $1500 \text{ m s}^{-1}$ .)

© MOE, FDR Ethnic Studies  
Not to be republished

# Index

- absolute pressure 160, 161  
absolute zero 174, 175  
acceleration 19–21, 26  
  direction 32–33  
  force and 20, 55–58  
  mass and 56–57  
  *see also* uniformly accelerated motion  
air pressure 142–150  
air resistance 34  
altitude  
  atmospheric pressure and 145  
  density and 153  
amplitude of waves 214–215  
aneroid barometers 146  
angular momentum 74  
apparent weight 61, 163–164, 165  
Archimedes 119, 130, 164  
  Archimedes' principle 164–165  
Aristotle 44, 45  
atmospheric pressure 143–147, 156, 160, 161
- balanced forces 55  
barometers 146–147  
bicycle pumps 149–150  
bimetallic strips 185–186  
boiling points 145, 200, 201  
Bourdon gauges 161  
buoyant force 162–164
- calories (cal) 191  
calorimeters 194–195  
Celsius scale 174–175  
changes of state 200–204  
closed systems 102  
coefficient of friction 66–67  
coefficient of linear expansion 180  
collisions 76–78  
  conservation of energy in 103–104  
  elastic and inelastic 83, 103–104  
complex machines 136–137  
compound pulleys 134  
compressions 212  
conservation of energy, law of 102–105, 177  
conservation of linear momentum, law of 76–78, 79, 81–82  
constructive interference 226  
contact forces 44  
continuous waves 209  
cooling curves 200–201  
Coriolis, Gaspard-Gustave 88  
crests of waves 210–211
- density  
  of floating objects 167–168  
  of fluids 152–153  
  relative 153–154, 167  
  waves and 219–220, 231, 236  
destructive interference 226  
differential pulleys 137  
diffraction 225  
displacement 16, 26–27  
displacement-time graphs 22–25, 36  
distance 16  
distance-time graphs 24–25  
drinking straws 148
- Earth  
  atmosphere 143–146, 153  
  gravitational field strength 58–59, 72  
  as reference frame 37  
  seismic waves in 218–220  
earthquakes 218–220  
echoes 234  
efficiency of machines 121–123, 125, 127, 130  
effort 117  
elastic collisions 83, 103–104  
elastic deformation 51  
elastic limit 50–51  
elastic potential energy (EPE) 100  
electrical work 89  
electricity, generation 106  
electromagnetic forces 43  
electromagnetic waves 217  
energy  
  conservation of 102–105, 177  
  forms 96  
  heat *see* heat energy  
  kinetic *see* kinetic energy  
  in oscillating systems 104–105  
  potential *see* potential energy  
  total mechanical energy 100  
  units of 96, 111–112, 191  
  in waves 208  
  work and 88, 96–100  
energy resources 105–106  
  in Ethiopia 108, 109  
  renewable 106–108  
equilibrant forces 53, 55  
equilibrium 10–13, 143  
  linear 84–85  
  thermal 176  
expansion joints 185  
explosions 78–79, 212
- Fahrenheit scale 174–175  
fixed pulleys 134  
floating objects 166–167  
fluids 151–152  
  density of 152–153  
  forces in 162–165  
  pressure in 154–156  
  *see also* gases; liquids  
force pumps 148–149  
force-distance graphs 92–94  
force-extension graphs 48, 49  
forces 43–44  
  acceleration and 20, 55–58  
  effects of 44–45, 46–50  
  in equilibrium 10–13  
  in fluids 162–165  
  Newton's pairs 72–73  
  pressure and 141–142  
  resolving 7–8, 53–55, 57–58, 62–63  
fossil fuels 106  
free body diagrams 43–44  
free fall 34–36  
frequency of waves 216  
friction 64–65  
  calculating 66–69  
  effects of 70, 118  
  factors affecting 65–66  
  reducing 69–70  
  work done against 91–92  
fulcrum 128, 131–132
- Galileo Galilei 34, 119  
gases 151–152, 188  
gauge pressure 160–161  
gears 133–134  
geothermal power 107, 108, 109  
graphs  
  displacement-time 22–25, 36  
  distance-time 24–25  
  force-distance 92–94  
  force-extension 48, 49  
  velocity-time 25–27, 32, 36  
gravitational field strength 58–60, 72  
gravitational potential energy (GPE) 99–100  
gravity 43, 44  
  acceleration due to 34, 35, 60  
  work done against 90, 91–92
- hearing 229, 230  
heat capacity 197–198

- heat energy 101, 102, 172, 175
  - absorption 176, 191–192
  - changes of state 200–204
  - from friction 91, 118
- heating curves 200
- Hooke's law 47–49, 51, 93
- hot riveting 185
- hydraulic machines 157, 158–159
- hydroelectric power 107, 108
  
- ice, specific latent heat of fusion 203–204
- impulse of a force 80–81
- inclined planes 68–69, 119, 124–125
- inelastic collisions 83, 103–104
- inertia 45–46
- inertial frame of reference 37
- instantaneous speed 18
- instantaneous velocity 18
- intensity of sound waves 234–236
- interference 226–227
  
- jackscrow 137
- joules (J) 88, 89, 111–112, 191
  
- Kelvin scale 174–175
- kilograms (kg) 58
- kilowatt-hour (kWh) 111–112
- kinetic energy 96–98, 102
  - in collisions 83, 103–104
  - linear momentum compared 103
  - in oscillating systems 104–105
  - temperature and 172–174
  - work and 97–98
- kinetic friction 65, 91–92
  
- latent heat
  - of fusion 201
  - of vaporisation 201
- law of flotation 166
- laws of thermodynamics
  - first law 177–178
  - second law 178
- levers 119, 128–130
  - in the body 132
  - classes of 131–132
- lift pumps 148
- lifts
  - hydraulic 158, 159
  - passenger weight in 61–62
- light, speed of 37
- light waves 208
- limiting friction 65
- linear equilibrium 84–85
- linear expansion 180–181, 184
- linear momentum 74–76
  - kinetic energy compared 103
  - law of conservation of 76–78
  - Newton's laws and 79–80, 81–82
- liquids 151–152, 187–190
- load 47, 117
- longitudinal waves 211–213, 215
  
- loudness 233
- lubrication 70
  
- mach numbers 232
- machines 117–118
  - complex 136–137
  - as direction changers 120
  - efficiency of 121–123
  - as force multipliers 119
  - hydraulic 157, 158–159
  - simple 118–119, 124–136
  - as speed multipliers 119–120
- Magdeburg hemispheres 144–145
- magnetic forces 44
- magnitude 2
- manometers 161–162
- mass 58–59
  - acceleration and 56–57
  - inertia and 46
  - kinetic energy and 96–97
- mass-spring systems 105
- mechanical advantage (MA) 120–121
  - efficiency and 121–123
  - of simple machines 125, 126, 127, 129–130, 132, 134, 137
- mechanical waves 217–220
- mechanical work 88–89
  - against friction 91–92
  - against gravity 90, 91–92
  - calculating 88–90
  - kinetic energy and 97–98
  - machines 117–118
  - positive or negative 95
  - potential energy and 98–99
  - variable forces 92–94
- melting points 200, 201
- Moon 34, 59–60, 225, 226
- movable pulleys 134
- musical instruments 220, 228, 234
  
- newtonmeters 50
- Newton's laws of motion
  - first law 45, 97
  - linear momentum and 79–80, 81–82
  - second law 55–58, 62–63, 79–80, 97
  - third law 71–74
- newtons (N) 44, 57
- Newton's pairs 72–73
- non-contact forces 44
- nuclear forces 43
- nuclear power stations 106
  
- oscillating systems 104–105
- oscilloscopes 232–233
  
- parallelogram method 5, 7
- pascals (Pa) 141, 142
- Pascal's principle 157–158
- pendulums 105
- pitch 233
  
- plastic deformation 51
- Plimsoll line 167
- polishing 69
- pollution 106
- potential energy 98–100, 102
  - in oscillating systems 104–105
  - work and 98–99
- power 110–111
  - velocity and 113–114
- pre-natal scanning 237
- pressure 141–142
  - depth and 154–155
  - direction of 156
  - effect on volume 153
  - in fluids 154–156
  - measuring 161–162
- pulley systems 119, 134–136, 137
- pumps 148–150
- Pythagoras's theorem 5–7, 54
  
- rack and pinion 134
- radioactive waste 106
- rarefactions 212
- real weight 61
- reference frame 37
- reflection 223–224, 234, 237
- refraction 224, 237
- relative density 153–154, 167
- relative velocity 37–39
- renewable energy resources 106–108
- resultant forces 7–8, 53–55, 57–58, 62–63
- resultant vectors 4, 7–9
- reverberation 234
- ripple tanks 227
  
- scalar quantities 2, 3
- scale diagrams 11, 84
- screws 119, 127
- seismic waves 218–220
- simple machines 118–119, 124–136
- siphons 150
- solar power 107–108
- solids, thermal expansion 179–184, 188
- SONAR 237
- sound waves 208, 212, 228–229
  - characteristics 232–233
  - intensity 234–236
  - reflection 234, 237
  - refraction 237
  - speed of 230–232, 236
  - uses 237
- specific gravity 154
- specific heat capacity 191–192
  - determination of 193–197
  - of water 198
- specific latent heat 201
  - of fusion 201, 202, 203–204
  - of vaporisation 201–202
- speed 17–18
- spring balances 49–50, 67

spring constant 49  
 springs  
     deformation of 50–51  
     effect of forces on 47–49  
     elastic potential energy 100  
 state, changes of 200–204  
 static friction 64–65  
 suction pads 148  
 surface area expansion 181–183, 184  
 SUVAT equations see uniformly accelerated motion  
  
 Teflon 67  
 temperature 153, 172–174  
 temperature scales 174–175  
 thermal contact 176  
 thermal equilibrium 176  
 thermal expansion 176  
     applications 185–186  
     of gases 188  
     of liquids 187–190  
     of solids 179–184, 188  
 thermometers 186  
 timbre 233  
 time period 216  
 total mechanical energy 100  
 transmission 133  
 transverse waves 210–211, 213  
 triangle of vectors 11  
 triangulation 219  
  
 troughs of waves 210  
 tsunamis 218, 219  
  
 ultrasound 237  
 unbalanced forces 55  
 uniform motion 16–18  
 uniformly accelerated motion 20  
     displacement-time graphs 22–25  
     equations 28–33  
     free fall 34–36  
     velocity time graphs 25–27  
  
 vacuum, waves in 217, 228  
 vacuum pumps 144  
 vectors 1–3  
     combining 4–7  
     resolving 7–9  
 velocity 17–18, 20, 23–24  
     direction 32–33  
     power and 113–114  
     relative 37–39  
 velocity ratio (VR) 120, 121  
     efficiency and 121–123  
     of simple machines 125, 126, 129–130, 132–133, 135, 137  
 velocity-time graphs 25–27, 32, 36  
 Venus 144  
 volume expansion 183–184  
 Vomit Comet 62  
  
 water  
     specific heat capacity of 198  
     thermal expansion of 189–190  
 water waves 217–218, 219  
 watts (W) 110  
 wave equation 217, 221–223  
 wave pulses 209  
 wave speed 214  
 wavelength 215  
 waves 208–209  
     behaviour 223–227  
     characteristics 214–217  
     electromagnetic 217  
     longitudinal 211–213, 215  
     mechanical 217–220  
     movement of particles in 208, 211, 212  
     sound 208, 212, 228–237  
     transverse 210–211, 213  
 wedges 119, 125–127  
 weight 43, 58–59  
 weightlessness 60–62  
 wheel and axle 119, 132–133  
 wind power 107  
 work-energy theorem 96–100



